



FITTING INSTRUCTIONS

FRONTERA 2000 ON AIR BAG COMPATIBLE COMBINATION BAR RODE0 / AMIGO 2000 ON (USA)

PRODUCT NUMBER
3448200

FITTING KIT NUMBER
6171398

WARNING

FOR VEHICLES EQUIPPED WITH SRS AIRBAG
WHEN INSTALLED IN ACCORDANCE WITH THESE INSTRUCTIONS, THE FRONT
PROTECTION BAR DOES NOT AFFECT OPERATION OF THE SRS AIRBAG.

TAKE NOTE OF THE FOLLOWING:

- **THIS PRODUCT MUST BE INSTALLED EXACTLY AS PER THESE INSTRUCTIONS USING ONLY THE HARDWARE SUPPLIED.**
- **IN THE EVENT OF DAMAGE TO ANY BULL BAR COMPONENT, CONTACT YOUR NEAREST AUTHORISED ARB STOCKIST. REPAIRS OR MODIFICATIONS TO THE IMPACT ABSORPTION SYSTEM MUST NOT BE ATTEMPTED.**
- **DO NOT USE THIS PRODUCT FOR ANY VEHICLE MAKE OR MODEL, OTHER THAN THOSE SPECIFIED BY ARB.**
- **DO NOT REMOVE LABELS FROM THIS BULL BAR.**
- **THIS PRODUCT OR ITS FIXING MUST NOT BE MODIFIED IN ANY WAY.**

USE	PART No	QTY	DESCRIPTION
CHASSIS BRACKETS TO CHASSIS RAILS	6151232	4	BOLT M10 x 1.5 x 30mm
	4581048	4	WASHER SPRING M10
	4581040	8	WASHER FLAT M10
	6151026	4	NUT M10 x 1.5mm
	3756224L	1	CHASSIS BRACKET ASSY
	3756224R	1	CHASSIS BRACKET ASSY
SPLASH PAN TO BULL BAR	6151021	2	BOLT M8 x 20mm
	4581044	2	WASHER FLAT M8
	3314413	1	SPLASH PAN
	6151132	2	NUT FLANGE
BULL BAR TO CHASSIS BRACKETS	6151045	6	BOLT M10 x 25mm
	4581048	6	WASHER SPRING M10
	4581040	6	WASHER FLAT M10
CONTROL BOX BRACKET	6151021	2	BOLT M8 x 20mm
	4581044	2	WASHER FLAT M8
	6151132	2	NUT FLANGE M8
	3751564	1	BRACKET CONTROL BOX
NUMBER PLATE BRACKET	6151017	4	BOLT M6 x 16mm
	6151035	4	WASHER FLAT M6
	6151128	4	NUT FLANGE M6
	3751313	1	NUMBER PLATE BRACKET
BUFFERS AND TURN SIGNALS	3500170	1	BUFFERS KIT
	3500080	1	ARB TURN SIGNALS
8-9000lb WINCH TO PAN	4581040	4	WASHER FLAT 3/8"x 1"
	180302	6	CABLE TIES

TOOLS REQUIRED

1 BASIC TOOL KIT, DRILL.

ASSEMBLY SEQUENCE FOR BULL BAR INSTALLATION.



1. Remove bumper bar from the vehicle.
2. Fit the indicators into bar.
3. Fit numberplate bracket to bull bar using 6mm hardware if bar is going to have a winch fitted.
4. Fit buffers to bull bar using 6mm flange nuts supplied in buffer kit.

NOTE: DO NOT OVER-TIGHTEN.



If fitting XP 9.5 winch, continue to step 5, otherwise, jump to step 12.

5. If fitting the XP 9.5 winch, remove the cover from the control box.

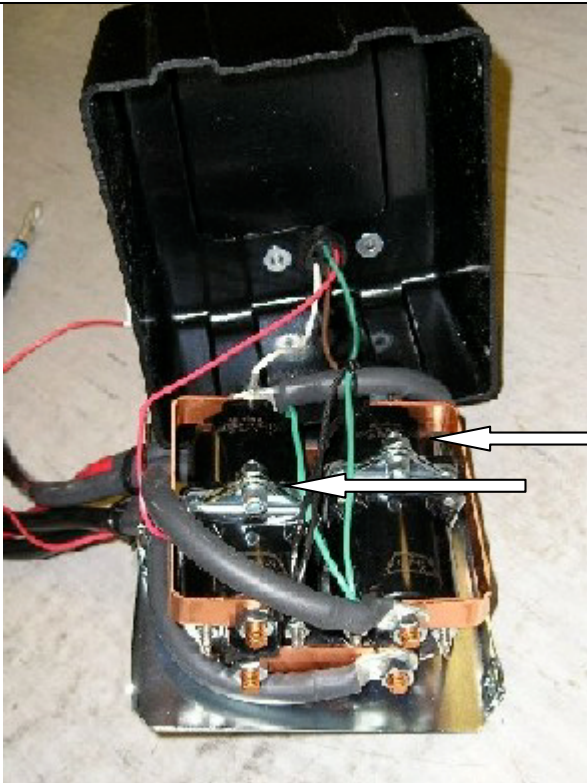

6. Remove the two cap screws, nuts and spacer washers that hold the four solenoids in place.

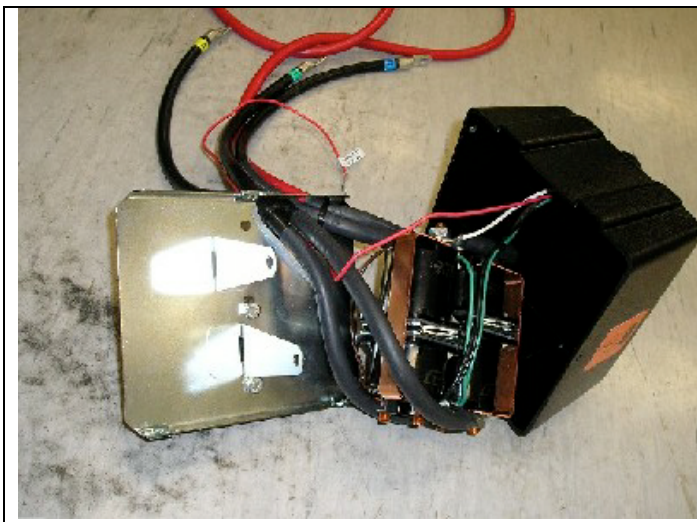

7. Remove the four solenoids from the base of the control box using the copper bus bar as an aid and hold to one side.

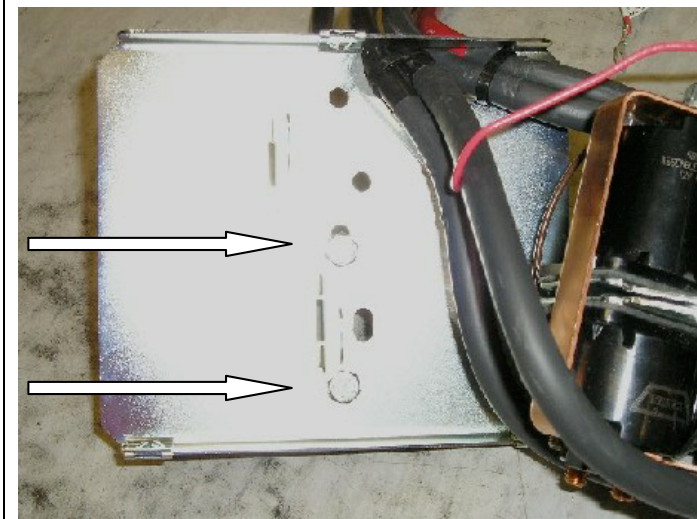

Before

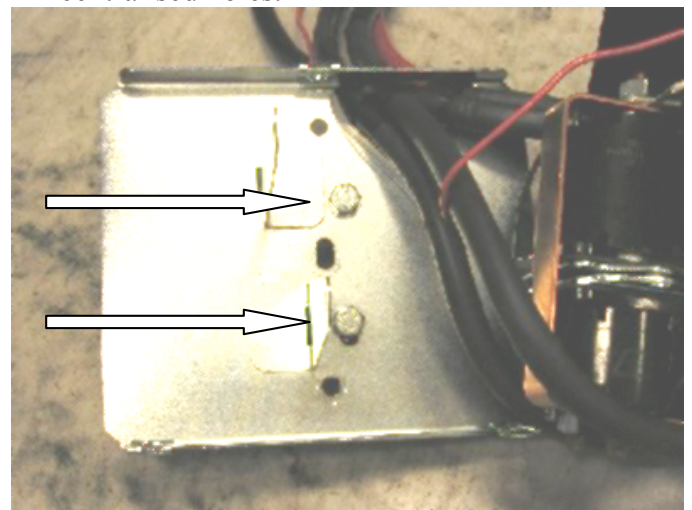

After

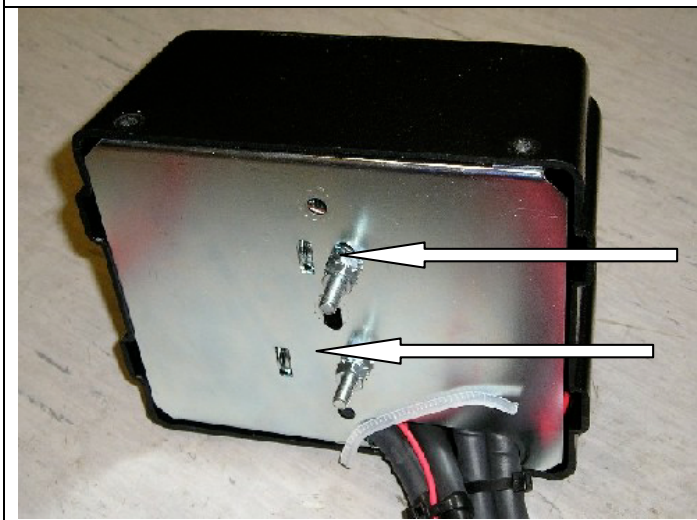

9. Place the 4 solenoids over the 2 metal stands that are facing upwards. Make sure they line up with the holes in the base.



10. Replace the 2 cap screws, washers and nuts removed in step 6 above into original holes.
11. Replace the black cover and refit the three cover screws (DO NOT OVER TIGHTEN)

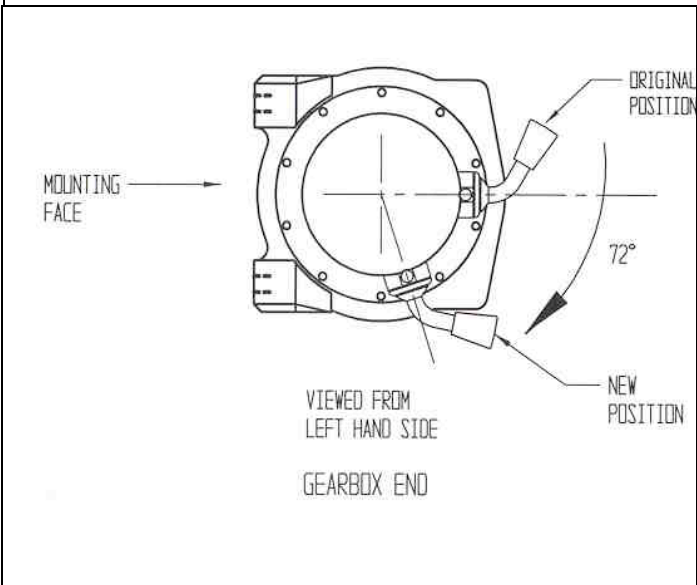

12. Fit control box bracket to bull bar using 8mm hardware.
13. To place the clutch handle in the correct position, the winch gearbox must be rotated 72 degrees (2 hole spacings), in clockwise direction when viewed from gearbox end. Place the winch on its end and remove all gearbox bolts. Gently raise the gearbox just enough to rotate it. When the correct position is located, refit all bolts and tighten.

NOTE: Take care not to lift the assembly more than a couple of millimeters while rotating to correct position to avoid unmeshing the gears.



14. Once winch is rotated, position winch on bench face up.
15. Lower bull bar on top of winch and align holes with each other.
16. Place roller fairlead in bar cutout over lower holes and fasten using 3/8" Warn hardware and 4 3/8" flat washers supplied in bolt kit.
17. When all is positioned, tighten all bolts firmly.

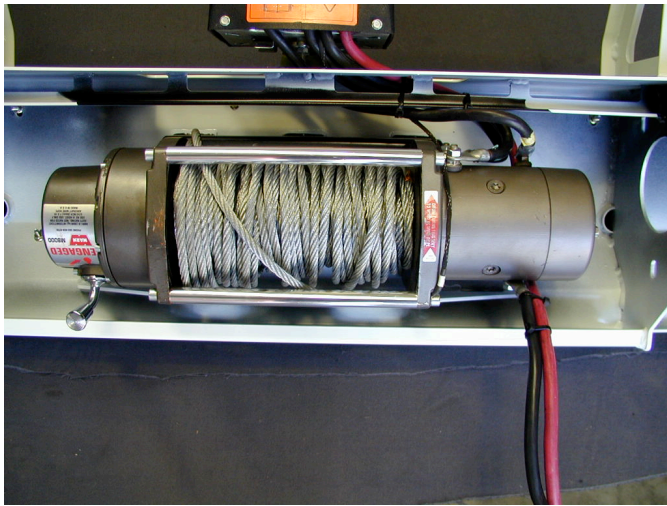

18. Fit control box to control box bracket and tighten firmly.
19. Pull wires through viewer cutout under control box and wire up as per Warn instruction manual.
20. Tie back cables clear of all moving parts with cable tie supplied.
21. Place ground earth lead under bolt of winch tension bar.

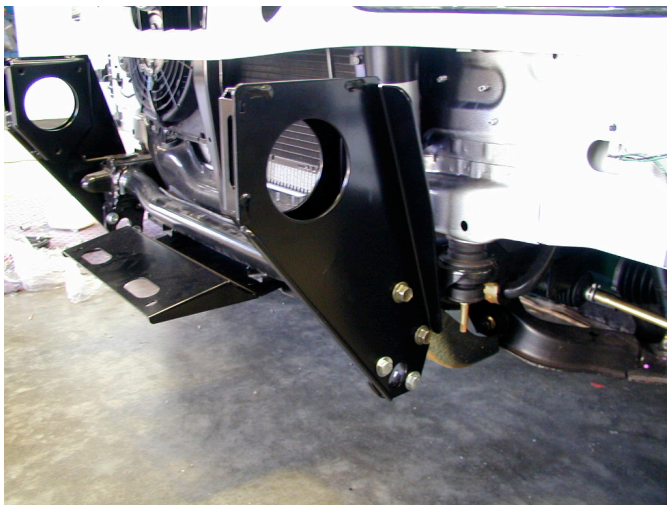

22. Fit chassis brackets to both sides of the vehicle using original 12mm bolts.
23. Fit 10mm x 30mm bolts to lower holes and fasten using 10mm hardware.
24. When all bolts are fitted, tighten firmly.



25. Lift bar into position between chassis brackets and bolt up using M10 x 25mm bolts, spring and flat washers. Finger tighten only. (Bolts fit from inside of bar.)
26. Adjust bar so that there is a 20mm gap around the periphery of the vehicle and securely tighten all remaining bolts throughout.
27. Wire main power leads to battery as per Warn instructions and cable tie leads securely from all moving parts with cable ties supplied.
28. Fit number plate to number plate bracket (**winch**) or fit number plate to lower holes in bar face to cover roller fairlead cutout (**non winch**) using 6mm hardware.
29. Pull winch cable through roller fairlead, and fit tow hook.



30. Connect the turn signal looms to the existing turn signal loom with the Scotchloks supplied. Test to ensure the turn signals function correctly.
31. Once bar is correctly fitted, undo front bolts in splash pan of vehicle, slide splash pan supplied between and refit bolts and finger tighten.
32. Using 8mm hardware supplied, bolt splash pan to front of underside of bar. When all bolts are fitted, tighten firmly.



33. If driving lights are to be fitted, use extension bar with ratchet, $\frac{3}{4}$ " long reach socket to tighten from cutout in bottom of center pan.
34. Winch handle is operated from underneath bull bar from left-hand side of vehicle.