



102 S. Michigan Ave., Coldwater, MI 49036

Phone: 517-279-2135

Web/live chat: [www.bds-suspension.com](http://www.bds-suspension.com)

E-mail: [tech@bds-suspension.com](mailto:tech@bds-suspension.com)

Part#: **021626**

Product: **High Clearance Suspension System**

Application: **1999-2006 1/2 Ton Chevy/GMC 4WD**

---

## READ AND UNDERSTAND ALL INSTRUCTIONS AND WARNINGS PRIOR TO INSTALLATION OF SYSTEM AND OPERATION OF VEHICLE.

---

**SAFETY WARNING** BDS Suspension Co. recommends this system be installed by a professional technician. In addition to these instructions, professional knowledge of disassembly/ reassembly procedures and post installation checks must be known.

**PRODUCT SAFETY WARNING** Certain BDS Suspension products are intended to improve off-road performance. Modifying your vehicle for off-road use may result in the vehicle handling differently than a factory equipped vehicle. Extreme care must be used to prevent loss of control or vehicle rollover. Failure to drive your modified vehicle safely may result in serious injury or death. BDS Suspension Co. does not recommend the combined use of suspension lifts, body lifts, or other lifting devices.

You should never operate your modified vehicle under the influence of alcohol or drugs. Always drive your modified vehicle at reduced speeds to ensure your ability to control your vehicle under all driving conditions. Always wear your seat belt.

### PRE-INSTALLATION NOTES

1. Special literature required: OE Service Manual for model/year of vehicle. Refer to manual for proper disassembly/ reassembly procedures of OE and related components.
2. Adhere to recommendations when replacement fasteners, retainers and keepers are called out in the OE manual.
3. Larger rim and tire combinations may increase leverage on suspension, steering, and related components. When selecting combinations larger than OE, consider the additional stress you could be inducing on the OE and related components.
4. Post suspension system vehicles may experience drive line vibrations. Angles may require tuning, slider on shaft may require replacement, shafts may need to be lengthened or trued, and U-joints may need to be replaced.
5. Secure and properly block vehicle prior to installation of BDS Suspension components. Always wear safety glasses when using power tools.
6. If installation is to be performed without a hoist, BDS Suspension Co. recommends rear alterations first.
7. Due to payload options and initial ride height variances, the amount of lift is a base figure. Final ride height dimensions may vary in accordance to original vehicle attitude. Always measure the attitude prior to beginning installation.

### POST-INSTALLATION WARNINGS

1. Check all fasteners for proper torque. Check to ensure for adequate clearance between all rotating, mobile, fixed, and heated members. Verify clearance between exhaust and brake lines, fuel lines, fuel tank, floor boards and wiring harness. Check steering gear for clearance. Test and inspect brake system.
2. Perform steering sweep to ensure front brake hoses have adequate slack and do not contact any rotating, mobile or heated members. Inspect rear brake hoses at full extension for adequate slack. Failure to perform hose check/ replacement may result in component failure. Longer replacement hoses, if needed can be purchased from a local parts supplier.
3. Perform head light check and adjustment.
4. Re-torque all fasteners after 500 miles. Always inspect fasteners and components during routine servicing.

# PARTS LIST

Part #	Qty	Description			
01171	1	Steering Knuckle		1	9/16"-12 x 4" bolt
01172	1	Steering Knuckle		2	9/16"-12 x 1-3/4" bolt
02178	1	Front Crossmember		4	9/16-12 prevailing torque nut
02335	1	Rear Crossmember		8	9/16" SAE washer
02183	1	Replacement Splash Guard		1	10mm prevailing torque nut
01337	1	Differential Bracket - Drv		5	10mm washer
01166	1	Differential Bracket - Pass		4	10mm-1.5 x 60mm bolt
3624RB	2	Bushing - Diff Mount		1	10mm-1.5 x 70mm bolt
15	1	0.750" x 0.083" x 2.955" Sleeve		4	1/2"-13 x 1-1/4" button head bolt
M02096RB	2	Pyramid Bump Stops		4	1/2" SAE washer
02338	1	Differential Skid Plate		2	7/16"-14 x 1-1/4" bolt
02187	1	Compression Tube		2	7/16"-14 prevailing torque nut
02173	1	Torsion Key Relocation (pass) - 6" Only		4	7/16" SAE washer
02174	1	Torsion Key Relocation (drv) - 6" Only	568	1	Bolt Pack (CV spacers)
02188	1	Torsion Key Relocation (pass) - 4" Only		12	10mm-1.5 x 70mm bolt
02189	1	Torsion Key Relocation (drv) - 4" Only		12	10mm washer
02180	2	Torsion Key Spacer - Long	569	1	Bolt Pack (Sway Bar Links)
02181	2	Torsion Key Spacer - Short		2	7/16" nylock nut
01165	2	CV Spacer		2	9/16"-12 x 2-3/4" bolt
02102	2	Sway Bar Link Bracket		4	9/16" SAE washer
SB35BK	2	Wide EB1 Bushing 3/4" ID		2	9/16"-12 prevailing torque nut
54587	4	0.750 x 0.090 x 1.575		2	5/8"-11 x 1-3/4" bolt
02154	2	Sway Bar Link 8-1/2"		4	5/8" SAE washer
S10024	4	Stem Washer		2	5/8"-11 nylock nut
4805G	4	Stem Bushing	570	1	Bolt Pack (ABS/Bumpstops)
02105	1	Weld in Plate		4	3/8"-16 x 1-1/4" bolt
621	1	Bolt Pack (Crossmembers)		8	3/8" SAE washer
	2	5/8"-11 x 4-1/2" bolt		4	3/8"-16 Prevailing torque nut
	2	5/8"-11 x 5-1/2" bolt		2	3/8"-16 hex nut
	4	5/8"-11 prevailing torque nut		2	3/8" SAE flat washer
	8	5/8" SAE washer		2	3/8" lock washer
566	1	Bolt Pack (Torsion Key Brackets)		2	1/4"-20 x 3/4" self-tapping bolt
	2	3/4"-10 x 5" bolt	01000	2	Rear Bumpstop Extension
	4	3/4" SAE washer	01711	1	Diff spacer sleeve
	2	3/4"-10 prevailing torque nut	342701	1	Loctite
	2	9/16"-12 x 1-1/2" bolt	099000	6	Zip Ties
	4	9/16" SAE washer			
	2	9/16"-12 prevailing torque nut			
567	1	Bolt Pack (Differential)			
	1	9/16"-12 x 4-1/2" bolt			

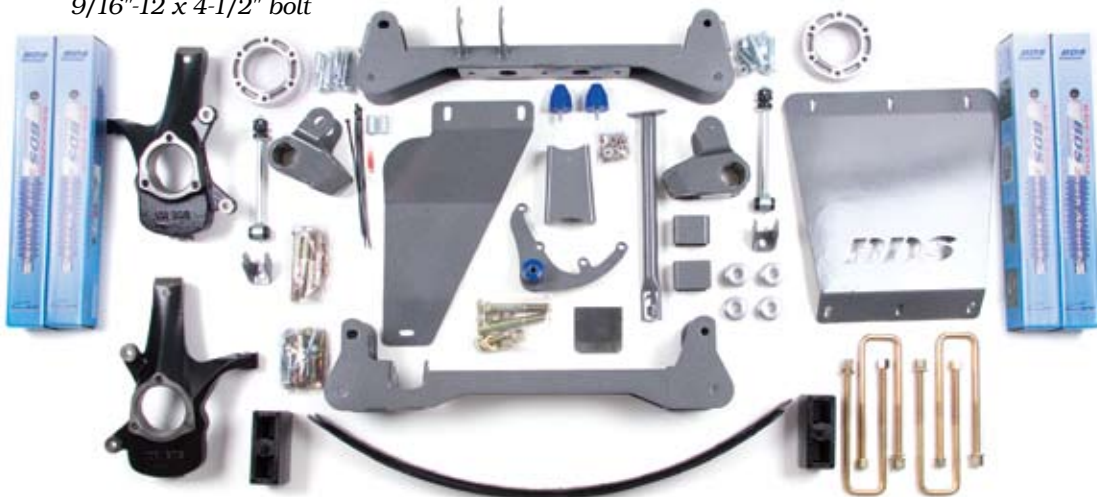

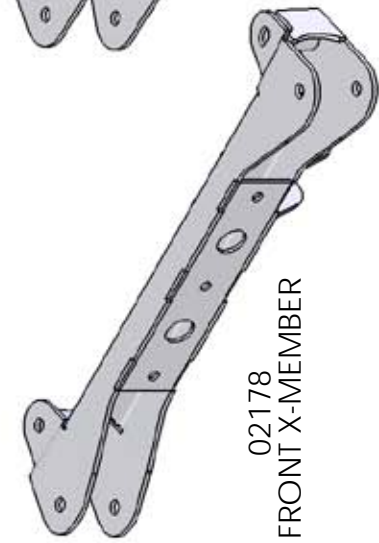

02178  
FRONT X-MEMBER

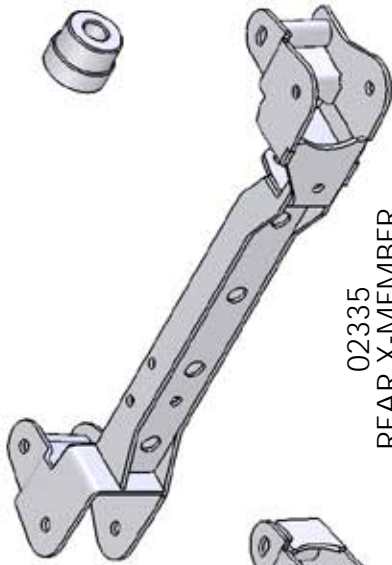

02335  
REAR X-MEMBER



02180  
LONG TORSION  
SPACER



02181  
SHORT TORSION  
SPACER



02154  
SWAY BAR LINK



02183  
FRONT SKID PLATE

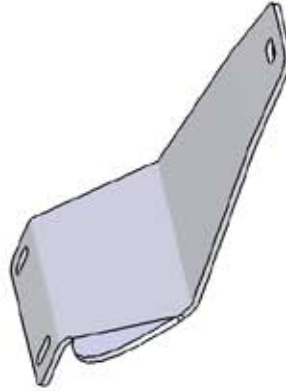

02338  
DIFF. SKID PLATE



02187  
COMPRESSION TUBE



02337  
DRV SIDE  
DIFF BRACKET



01165  
CV SPACERS

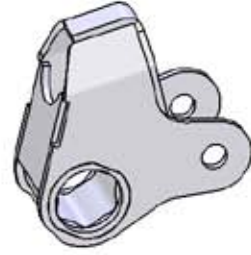

02173-02174  
TORSION BRACKETS



02102  
SWAY BAR BRACKET

NOTE: NOT TO SCALE

# INSTALLATION INSTRUCTIONS

## FRONT INSTALLATION

1. Safely raise the vehicle and support with jack stands for safety.
2. Remove the tires and wheels.
3. Measure and record the length of the exposed thread on the torsion bar adjusting bolts for later reference.
4. CAUTION: The torsion bar is under extreme pressure. Use the correct unloading tool to remove the pressure on the torsion bars before attempting to remove the assembly. A J36202 or equivalent torsion bar unloading tool must be used. Be sure to follow the OE manual and the torsion bar unloading tool literature as to how to unload the torsion bars.
5. Mark the unloaded torsion bars to indicate passenger's and driver's side. Mark both of the torsion bars to indicate the front versus the rear for later installation. Also mark the torsion bars relative to the control arms at the front to note indexing. Mark the rear of the bars relative to the adjusting arms to indicate indexing.
6. Remove the torsion bars by first removing the adjusting bolts then remove the retaining plates.
7. Drive the torsion bars forward using a maul or an air hammer through the access hole in the back of the torsion bar cross-member. Note: This will allow the torsion bar adjusters to drop free.
8. Remove the torsion bars by pulling them toward the front of the vehicle.
9. Remove the sway bar end links from the sway bar and lower control arms. Discard the end links.
10. Remove the shocks. Discard the shocks and retain the mounting hardware.
11. Remove the stock lower bump stops from the frame and discard.
12. Disconnect the tie rod ends from the steering knuckles. Remove and retain the mounting nuts. Strike the steering knuckle at the tie rod end to dislodge the end (Fig 1). Take care not to damage the tie rod end.

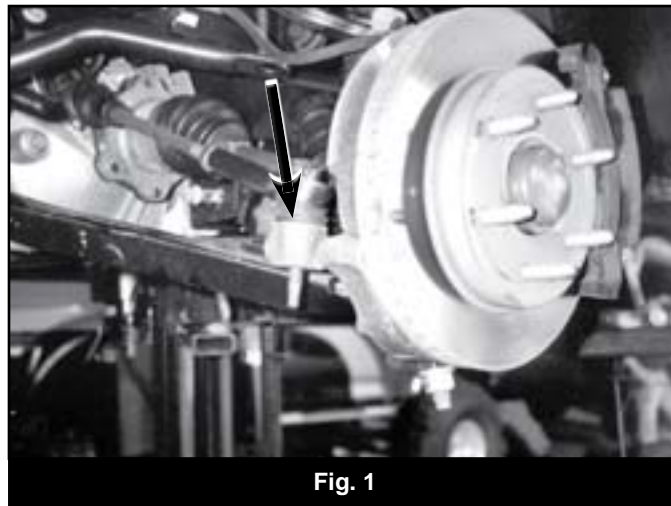

13. Disconnect the ABS brake wire from the frame and the control arm. Remove the brake hose bracket from the steering knuckle. Remove the brake caliper from the rotor and hang it securely out of the way. Do not hang the caliper by the brake hose.
14. Remove the wheel stud clips and discard. Remove the brake rotor from the steering knuckle. Remove the bearing cover, axle nut, and washer. Retain all hardware and parts.
15. Disconnect CV axles from the differential by removing the six mounting bolts (Fig 2). Remove the axles from the vehicle. Inspect the CV boots at this time. If they are damaged then replace them according to OE specifications.

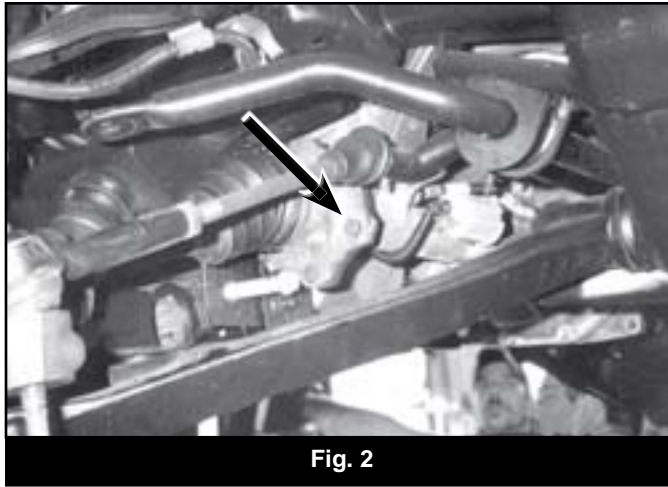

Fig. 2

16. Remove the upper and lower ball joint retaining nuts. Thread one of the nuts back on to catch the steering knuckle when it is broken loose from the ball joints.
17. Dislodge the upper and lower ball joints from the steering knuckle by striking the knuckle near the joint with a hammer (Fig. 3). Remove the knuckle assembly from the vehicle.

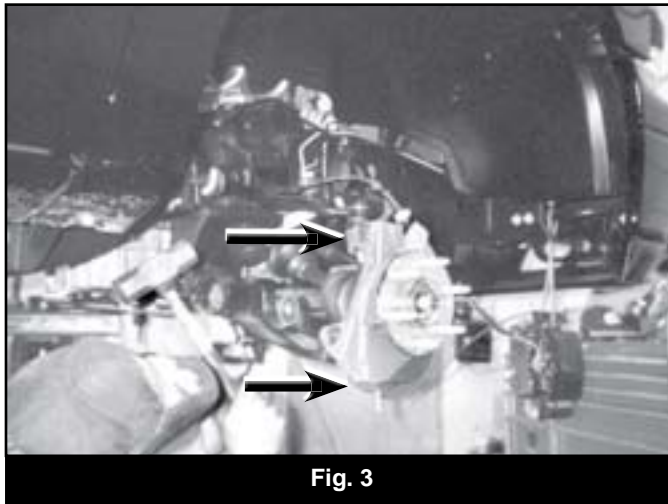

Fig. 3

18. Remove the three bolts that mount the hub assembly to the steering knuckle (Fig. 4). Discard the steering knuckle and retain the ball joint nuts and bearing assembly and hardware.





Fig. 4

19. Disconnect the lower control arms from the frame. Retain all hardware.
20. Remove the OE differential skid plate and splash shield. Retain hardware and splash guard and discard skid plate.
21. Make an alignment mark on the front of the driveshaft. Disconnect the front drive shaft from the differential. Retain the u-joint clamps and hardware.
22. Disconnect the electrical connector running to the differential housing (Fig 5). Remove the two retaining clamps holding the wire to the housing. Remove the vacuum line from the differential housing.



Fig. 5

23. Support the differential housing with a hydraulic jack. Remove the rear differential crossmember (Fig 6) and discard. Remove all differential housing mounting hardware. Carefully lower the differential from the vehicle. Retain all hardware.

*Caution: Flame cutting equipment is not recommended for use in frame bracket modification. A plasma cutter, cutoff wheel, or power hack saw is recommended. Be sure to check the area around the cuts to ensure that nothing is in the way. The vehicle undercoating is flammable. Be sure to keep a CO2 or ABC type fire extinguisher available.*

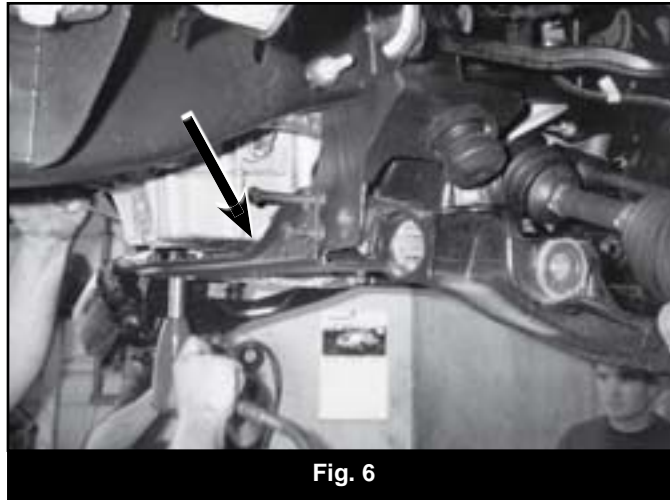

Fig. 6

24. The driver's side rear differential mount must be removed. Measure from the center of the OE control arm mounting hole inward 1-3/4" and make a vertical cut line around the entire pocket. (Fig 7A, 7B). Using a sawzall, die grinder or plasma cutter, remove the differential mount from the frame. Note: Always check for fuel lines and/or electrical wires before cutting. Undercoating is flammable. Keep a fire extinguisher close by for safety.

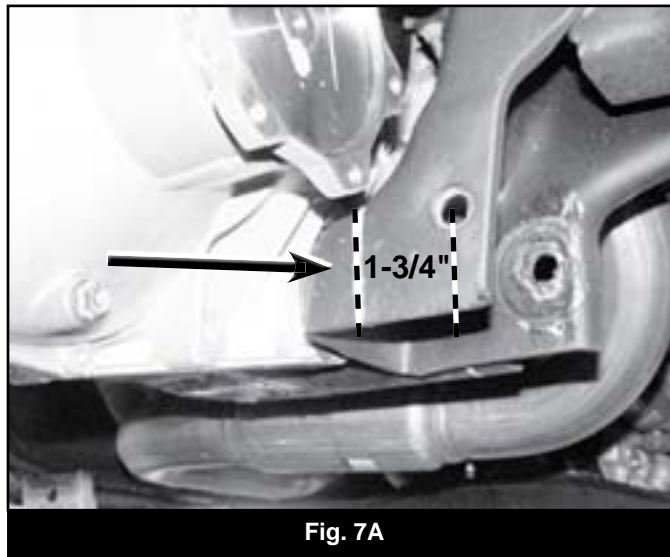

Fig. 7A

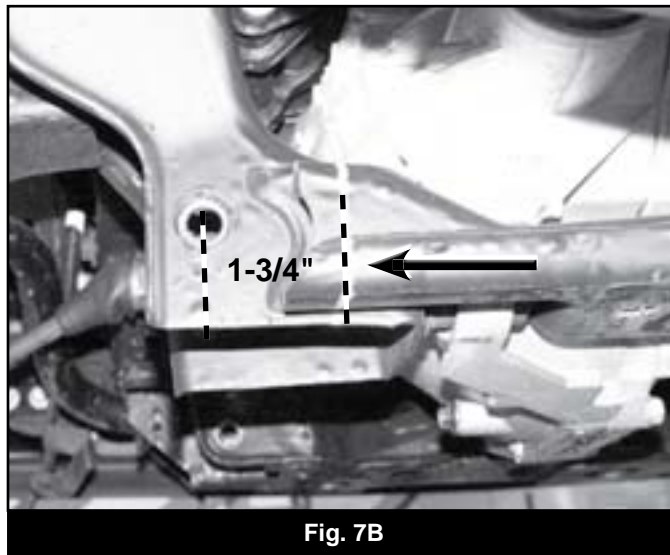
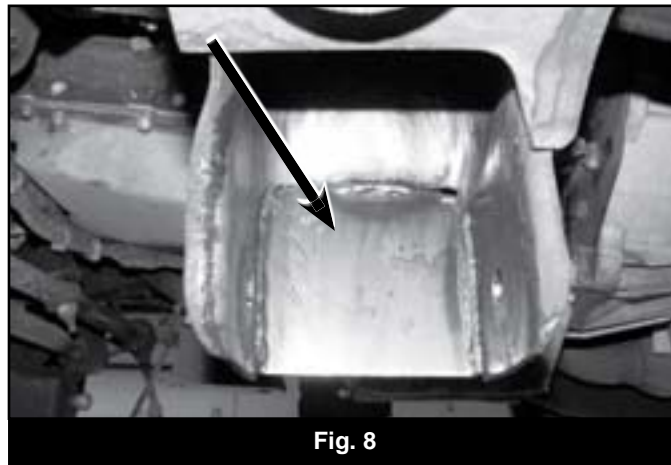

Fig. 7B

25. With the back of the control arm pocket removed, clean the area free of paint and grease. Place the provided plate up to the back of the pocket and weld in place. (Fig 8) Let the area cool and coat with a rust preventative paint or undercoating. Undercoating is flammable. Keep a fire extinguisher close by for safety. Welding should be performed by a certified welder.



26. The mounting bushing eye located on the upper front side of the differential housing must be removed. Mark a cut line on the housing that follows the contour of the top of the housing. Cut the eye off of the housing (Fig 9).



27. Install the bushings and sleeve in the C-shaped differential housing bracket. Set the differential housing bracket up to the housing in the appropriate location and remove the four housing bolts that correspond to the holes in the bracket (Fig 10).

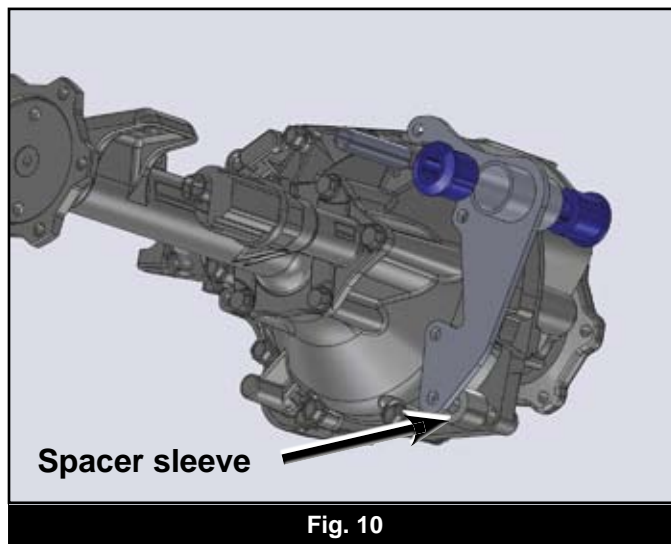



28. Using three 10mm x 60mm bolts and washers from bolt pack #567, attach the bracket to the differential housing in the tapped factory holes. Attach the remaining location with 10mm x 70mm bolt with washers, spacer sleeve, and locknut. Torque the bolts to 30 ft-lbs. Use Loctite® on mounting bolts that thread into the housing. Note: While working with the differential housing it is normal for some fluid leakage to occur. Check and fill as necessary when installation is complete.
29. The OE control arm pocket must be trimmed for clearance of the torsion bar under extreme wheel compression. Measure over 1" and draw a vertical line, draw a horizontal line from the center of the mounting hole over to the edge (Fig 11 & 13). Connect where these lines meet the edges and remove material. Next, use a file or rotary grinder to remove the sharp lip left from the control arms (Fig 12). This will allow the cross members to be installed easily.

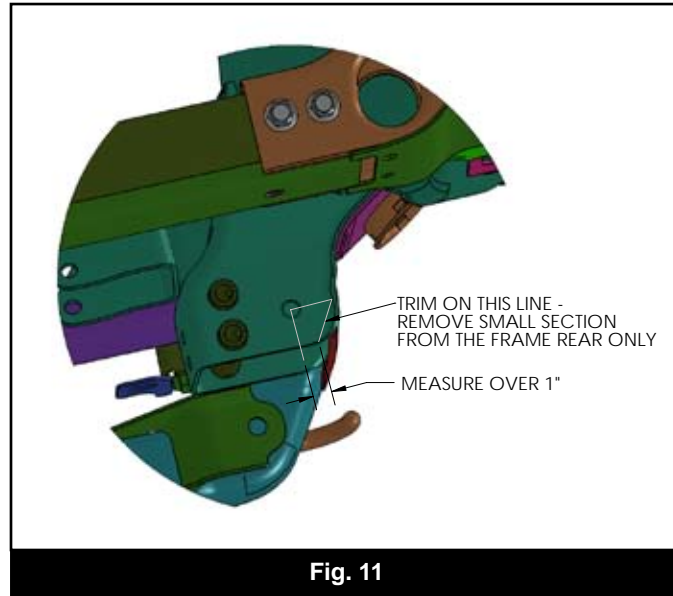

Fig. 11

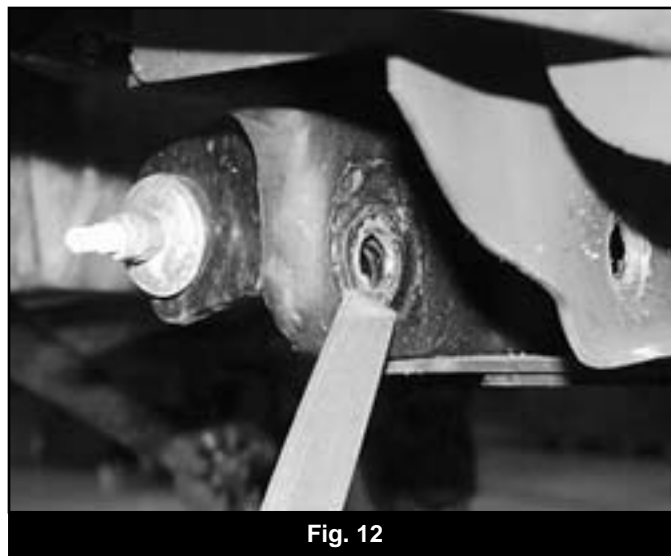
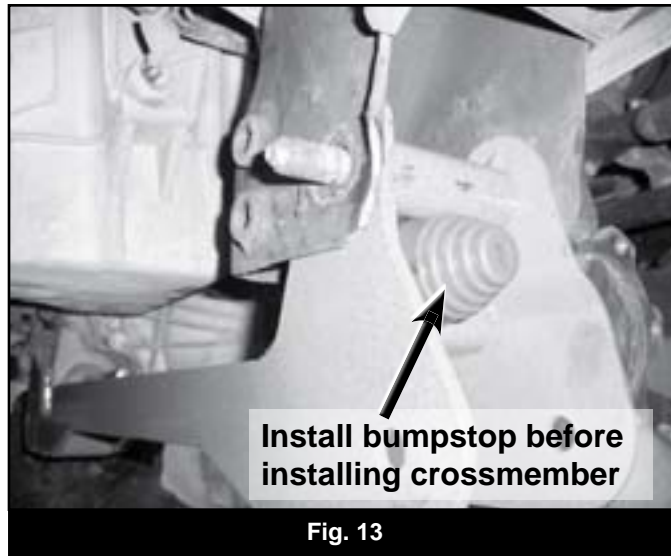
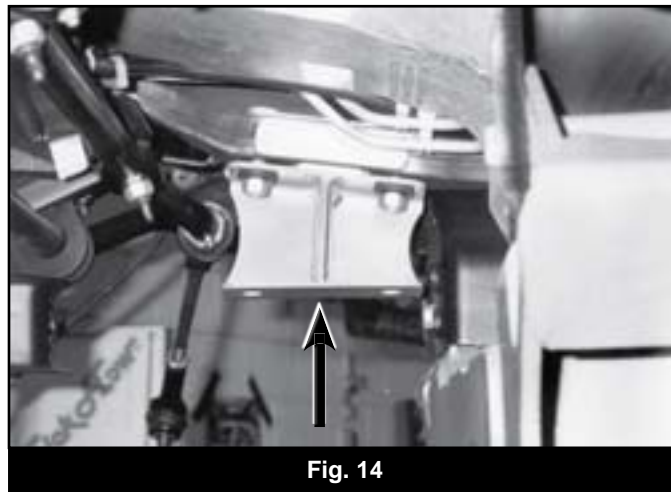

Fig. 12



30. 30. Install the new bump stops to the holes in the crossmember with 3/8" nuts from bolt pack #570 and tighten to 15 ft-lbs.
31. Install the new rear crossmember into the OE lower control arm pockets using the stock hardware. Leave hardware loose at this time.
32. Install the passenger's side differential bracket to the stock differential mount with the stock hardware (Fig 14). The wide end of the bracket goes toward the front of the vehicle. Torque mounting hardware to 70 ft-lbs.



33. Using a hydraulic jack, lift the differential housing assembly into the new rear crossmember (Fig 15). Attach the housing to the rear crossmember using a 9/16" x 4" bolt, nut, and washers, run the bolt from pass to driver's side. Attach the housing to the passenger's side bracket using 9/16" x 1 3/4" bolts, nuts, and washers from bolt pack #567. Do not tighten hardware at this time.

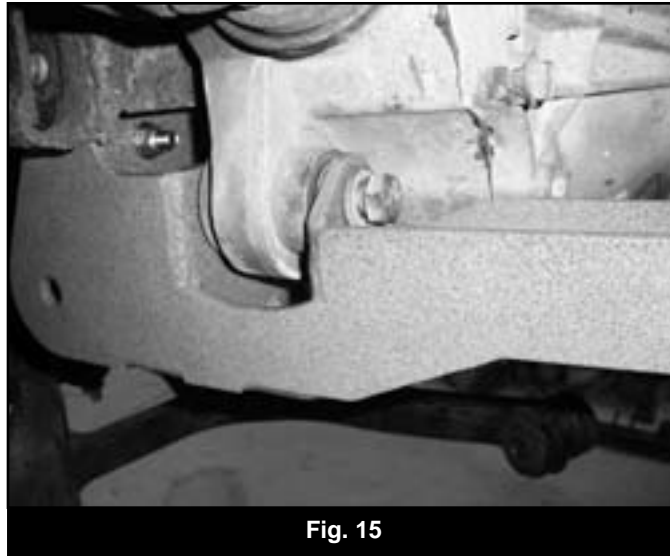

**Fig. 15**

34. Install new front crossmember into the OE lower control arm pockets with the stock hardware (Fig 16). Do not tighten. Using the stock bolts, attach the crossmember to the stock skid plate mounting holes through the access holes in the crossmember. Do not tighten.

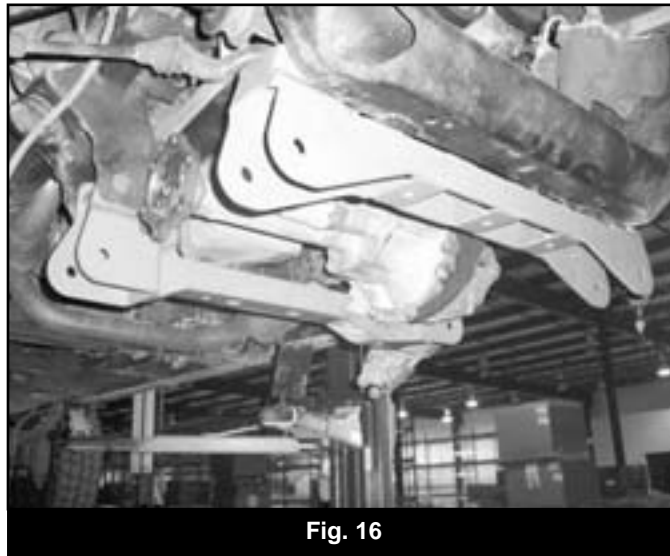

**Fig. 16**

35. Align the new front differential housing mount in the front crossmember tabs. Attach with a 9/16" x 4-1/2" bolt, nut, and washers from bolt pack #567 (Fig 17).

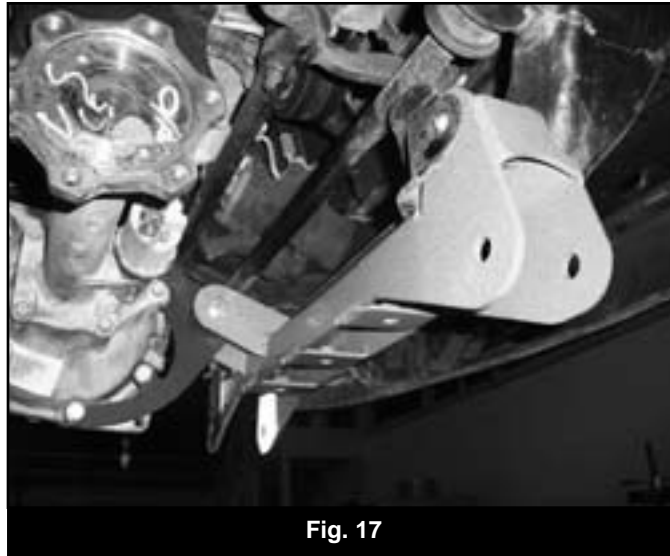

36. Torque the 9/16" differential hardware to 70 ft-lbs.
37. Install spacers (02180-02181) into control arms as shown in the attached figure. Place the torsion key relocation brackets on the arm, and install the 3/4" x 5 " bolt. Mark the center of the slot and remove bracket, drill this point out to 9/16". Repeat for opposite side. Note: It is easiest to drill these holes while the arms are off the vehicle.
38. Install the stock lower control arms in the new crossmembers using 5/8" x 5-1/2" (rear) and 5/8" x 4-1/2" (front) bolts, nuts, and washers from (Bolt pack # 621). Run the bolts from front to rear, leave hardware loose at this time.
39. Install torsion key relocation brackets with 3/4" x 5" and 9/16" x 1-3/4" bolt, washers, and nut (Bolt pack #566). Leave hardware loose. Run the 3/4" bolt from front to rear. (Fig 18 & 19)



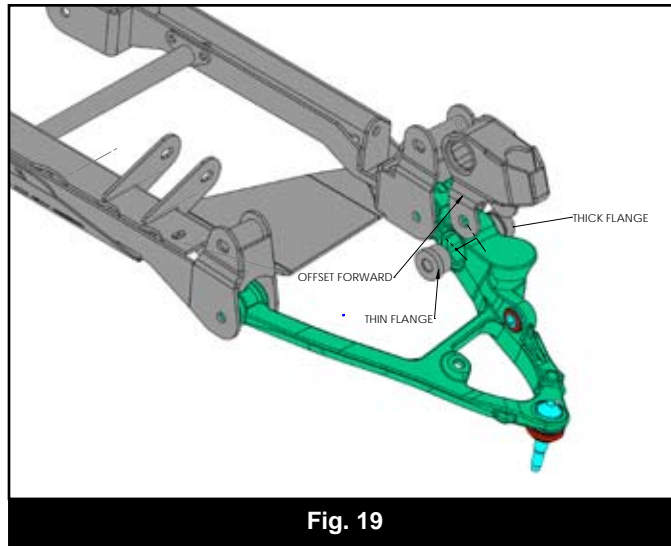

**Fig. 19**

40. Install new skid plate to the bottom of the rear crossmember using a 1/2" x 1-1/4" button head bolt with washer and loctite (Bolt pack #567). Leave bolt slightly loose.
41. Attach differential compression tube to rear crossmember with 7/16" x 1-1/4" bolts, washers, and nuts (Bolt pack #567). Align the front slot with the mounting hole in the front crossmember. (Fig 20)



**Fig. 20**

42. Install front skid plate with OE bolts at the top location, and 1/2" x 1-1/4" button head bolts with washers and loctite into front cross member. Tighten 1/2" and 7/16" hardware to 45 ft-lbs, OE 10mm bolts to 30 ft-lbs.
43. Torque the front and rear crossmember frame pocket bolts to 125 ft-lbs.
44. The brake dust shield needs to be trimmed. Measure in from the lower vertical edge (opposite the ABS sensor location) 3/4" and make a vertical cut line along the entire flat section (Fig 21). Cut the mark section off of the brake dust shield.



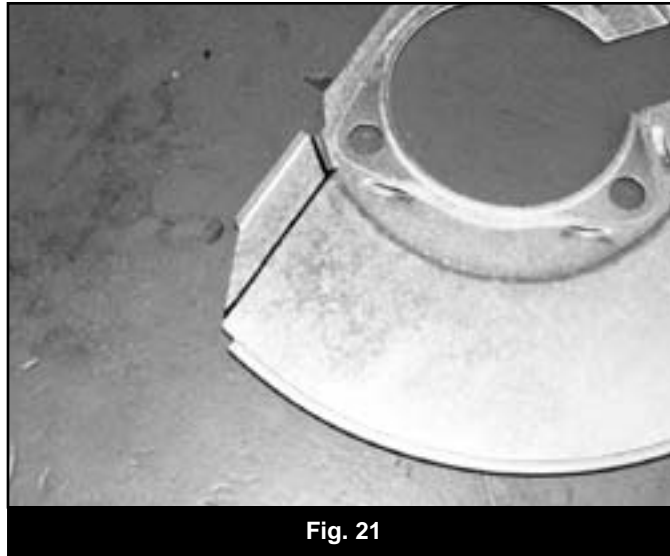

Fig. 21

45. Install the modified dust shield and hub/rotor in the corresponding new knuckles. Fasten the hub/shield with the OE bolts. Apply Loctite to the bolt threads and torque to 133 ft-lbs.
46. Install the hub assembly to the steering knuckle using the stock hardware, run the ABS wire out towards the steering arm, and torque flange bolts to 133 ft-lbs.
47. Install the new steering knuckles. Be sure to identify the driver's versus the passenger's side knuckles. Attach the upper control arm to the knuckle with the stock hardware and torque to 37 ft-lbs. Attach the lower control arm to the knuckle with the stock hardware and torque to 74 ft-lbs.
48. Install the brake rotor and brake caliper. Torque the caliper bolts to 125 ft-lbs.
49. Mount the brake hose to the back of the steering knuckle with the stock steel guide clamp using 1/4" x 3/4" self tapping bolt (Fig 22) from bolt pack #570. Ensure that the hose will not bind through full turning radius and will not make contact with the wheels/tires or suspension components.



Fig. 22

50. Raise the driver's side control arm several inches with a hydraulic jack (this will make installing the torsion bar easier). Install the torsion bar with the correct orientation thru the new bracket, transmission crossmember, and into the original torsion bar crossmember. Grease each side of the hex before installation into relocation key bracket and torsion key. The torsion key should be angled slightly below the original adjuster opening.
51. Lower the control arm and repeat for the opposite side. Do NOT load the torsion bars at this time.
52. Tighten torsion key relocation bracket on control arms as follows: 3/4" hardware 70 ft-lbs. 9/16" hardware 95 ft-lbs.
53. Using the provided wire ties, attach the ABS brake wire to the front leg of the upper control arm away from the wheel/tire.
54. Install the axle shaft through new knuckle and torque the nut to 155 ft-lbs. Install the bearing cover.

55. Install the CV spacers between the CV shaft and the differential housing using 10mm x 70mm bolts and washers (Fig 23) from bolt pack #568. Torque the bolts in a crossing pattern to 55 ft-lbs. Use Loctite® on the mounting bolts.

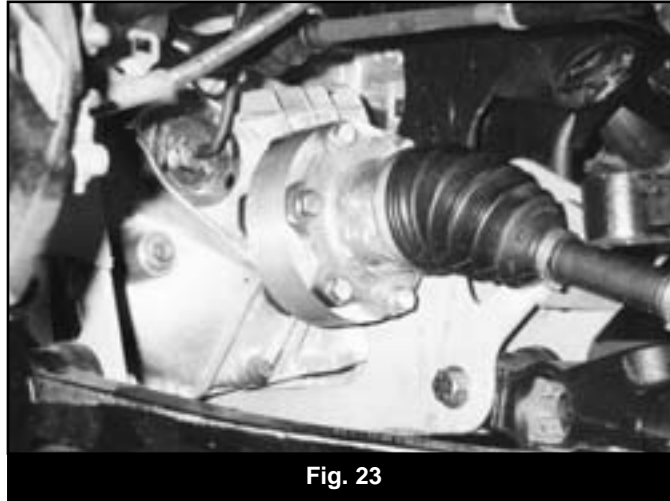

Fig. 23

56. Reconnect the vacuum line and electrical plug to the differential.
57. Reattach the drive shaft to the differential using the stock hardware. Torque fasteners to 19 ft-lbs.
58. Install the provided sway bar link u-brackets (02102) to the link mounting holes in the sway bar and lower control arm with 5/8" x 1-3/4" bolts, nuts, and washers from bolt pack #569. The bracket will be offset toward the inside of the vehicle. Torque bolts to 75 ft-lbs. (Fig 24)



Fig. 24

59. Make sure the sway bar is above the tie rod ends. Rotate the tie rod ends 180 degrees and attach them to the new knuckles from the top – down. Tighten nut to 37 ft-lbs.

60. Install the provided hourglass bushings (SB35BK) and sleeves (54587) in the eye of the new sway bar end links (02154). Attach the links in the brackets with 9/16" x 2-3/4" bolts, nuts and washers from bolt pack #569. Leave loose at this time.
61. Install a cup washer and bushing on the upper stem for both links. Swing the sway bar down and install additional bushing and cup washer. Secure with 3/8" nylock nut, tighten until the bushings begin to swell. Tighten lower 9/16" bolt to 55 ft-lbs.
62. Install BDS shocks using the stock hardware. Follow the installation instructions that accompany the shocks.
63. Install adjuster into torsion bar crossmember. Set the torsion bar bolts to the recorded thread measurements from the disassembly.
64. Install the front wheels and tires. Torque the lug nuts to manufacturer's specifications.
65. Lower the vehicle to the ground. Bounce the suspension to settle the ride height. Tighten lower control arm bolts to 110 ft-lbs.

## REAR INSTALLATION

*- If installing replacement rear leaf springs refer to the instruction sheets provided with box kit #011458/011558.*

*- If installing a 4.5" kit (box kit #011457) disregard the add-a-leaf instructions in steps 7-12.*

1. Safely raise the rear of the vehicle and support with jack stands for safety.
2. Remove the tires and wheels.
3. Place support floor jack under the rear axle.
4. Disconnect the rear brake line bracket from the frame rail by removing the two bolts retaining the bracket to the frame and retain the fasteners for later use. Complete the following steps one side at a time.
5. Lower the vehicle until the springs hang freely. With the rear axle well supported, remove the leaf spring U-bolts.
6. Remove the OE shock absorbers.
7. Use C-clamps to hold the spring assembly securely together.
8. Remove the leaf spring center pin and slowly remove the C-clamps.
9. Place the add-a-leaf between the second and third leaves. Place the rest of the leaves below the add-a-leaf.
10. Slide the 3/8" pin up through the leaf pack and start the nut to hold the pack together.
11. Do not use the center pin to draw the leaf pack together. Use a C-clamp on each side of the center pin to draw the pack together while ensuring that the leaves are in line. After the pack is drawn together, tighten the center pin.
12. Remove the C-clamps. Cut off any excess center pin.
13. Remove the OE block (if equipped). Position the new block between the spring pack and the spring perch. Make sure that the thick side of the block is toward the rear of the vehicle.
14. Slowly raise the floor jack under the axle while aligning the pin in the leaf pack with the hole in the block. Align the pin in the block with the OE spring pad.
15. Install two U-bolts over the OE spring plate, spring pack, block, and axle tube. From the under side of the axle tube, place the OE lower U-bolt plate over the U-bolts and hold the assembly together with the 9/16" high nuts and washers. Torque to 100-120 ft-lbs.

*Repeat steps for other side of vehicle*

16. Remove the rear rubber bump stops from the frame. Install the extension bracket (#01000) using 3/8-16x1-1/4" bolt and washer from bolt pack 570. Torque bolt to 20 ft-lbs. Install the OE bump stops to the bottom of the new bracket (Fig 20).
17. Install BDS shocks with stock hardware and torque upper and lower bolts to 65 ft-lbs. The axle mounting tabs may need to be bent open slightly to allow for clearance of the larger diameter shocks. Also, on the driver's side, the parking brake cable mounting bolt needs to be trimmed to avoid contact with the shock.
18. Place the brakeline bracket under the upper lip of the frame and attach it using OE mounting holes and hardware.
19. Check brake lines for proper slack and clearance.
20. Install wheels and tires. Torque lug nuts to manufacturer's specifications. Lower vehicle.

## POST INSTALLATION

1. Double check all fasteners for proper torque.
2. Check all moving parts for clearance.
3. Complete a full radius turning check to ensure that no interference occurs.
4. Align headlights
5. Double check the brake lines for adequate slack at full wheel travel. It may be necessary to install extended brake lines.
6. Complete a vehicle alignment to OE specifications, taking into account larger tires, if installed.
7. Check all fasteners after 500 miles.

*Note: Installation of larger tires may require speedometer adjustment.*

---

## NOTICE TO DEALER/INSTALLER

These instructions, the warning card, and included decals must be given to the owner of this BDS Suspension product.

---

For questions, technical support and warranty issues relating to this BDS Suspension product, please contact your distributor/installer before contacting BDS Suspension directly.

**Sold/Installed by:**