



2002 DODGE RAM 1500 INSTALLATION INSTRUCTIONS - KIT #60083

⚠WARNING

Installation of a Performance Accessories body lift will change the center of gravity and the handling characteristics of the vehicle. Because of the higher center of gravity and larger tires, the vehicle will handle and react differently both on and off road. You must drive it safely! Extreme care must be taken to prevent vehicle rollover or loss of control, which could result in serious injury or death. Avoid sudden sharp turns or abrupt maneuvers and always make sure all vehicle occupants have their seat belts fastened.

⚠WARNING

Read and understand all instructions, warnings, cautions, and notes in this sheet and in your owners manual before you begin the installation of this body lift kit.

⚠CAUTION

Proper installation of a Performance Accessories body lift kit requires knowledge of the factory recommended procedures for disassembly and assembly of original equipment components. We recommend that the factory shop manual and any special tools necessary to your vehicle be on hand during the installation. Installation of this body lift kit without proper knowledge of the factory recommended procedures may affect the performance of these components and the safety of your vehicle. We strongly recommend that a certified mechanic familiar with the installation of similar components install this body lift kit.

⚠WARNING

This body lift kit should only be installed on vehicles in good working condition. Before installation, the vehicle should be thoroughly inspected for evidence of corrosion or deformation of the sheet metal around the factory body mounts. This body lift kit should not be installed on any vehicle that is suspected to have been in a collision or misused. Off road use of your vehicle with this body lift installed may increase the stress applied to the factory body mounts. We do not recommend that any vehicle with a body lift installed be involved in any extreme off road maneuvers such as jumping. Failure to observe this warning may result in serious personal injury and/or severe damage to your vehicle.

⚠WARNING

Many states now have laws restricting bumper heights and vehicle lifts. Local laws should be consulted to determine if the changes you intend to make to your vehicle comply with state laws. Before combining a body lift with a suspension lift, consult an installation professional to see how this will affect your specific application.

⚠WARNING

The installation of larger wheel and tire combinations may reduce the effectiveness of the Anti-lock Braking System.

⚠WARNING

Always wear eye protection when operating power tools.

⚠WARNING

Ensure that your vehicle tires are properly blocked and secured before you begin installation of this lift kit.

⚠WARNING

The Supplemental Restraint System (SRS, or air bag) must be deactivated during lift kit installation to avoid accidental air bag deployment while working near SRS sensors and wiring. Do not allow anyone near the air bag during lift kit installation. Accidental deployment can result in serious personal injury or death. Refer to your factory service manual/owner's manual for the recommended procedure to disable the SRS. The SRS must be reactivated before driving the vehicle.

⚠NOTE

Performance Accessories recommends using the Loctite® supplied in the kit on all hardware unless noted in the instructions.

A. Before you start.

△NOTE

As you read through this procedure, note that each part referenced has the same callout number throughout. Also, the part number in the text matches the corresponding part number in the art. Kit parts are prefaced by the word *kit* in italics.

△NOTE

You will find it easier to keep track of hardware if immediately after removal you put the fasteners for each subassembly in a paper lunch bag and write on the bag where they go.

1. Read all warnings and instructions completely and carefully before you begin.
2. Check to make sure the kit is complete (refer to the Parts List, section E).
3. Only install this kit on the vehicle for which it is intended. If anytime during the installation you encounter something different from what is outlined in the instructions, call technical support at (928) 636-0979.
4. Park the vehicle on a clean, dry, flat, level surface and block the tires so the vehicle cannot roll in either direction.
5. Disconnect both battery cables. Disconnect the negative cable (1) first, then the positive cable (2) from the battery (3).
6. Turn thumbwheel (4), lift cover (5), and remove two airbag fuses #52 and #53 (6 and 7) from the fuse panel (8). Fuse locations may vary, so check fuse chart.

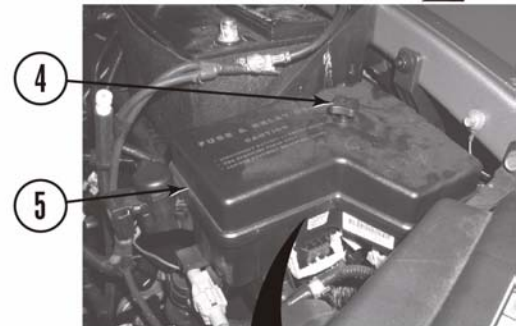
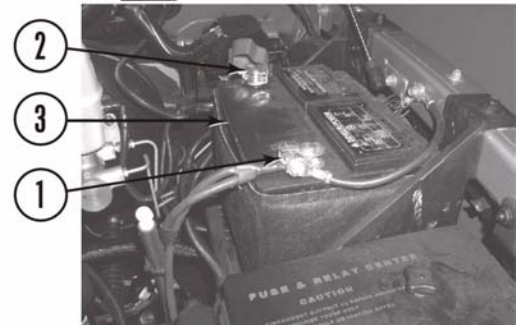

B. Get ready to install the kit.

1. Remove the front bumper.

a. Measure distance between the front bumper (9) and front fenders (10). Record measurement.

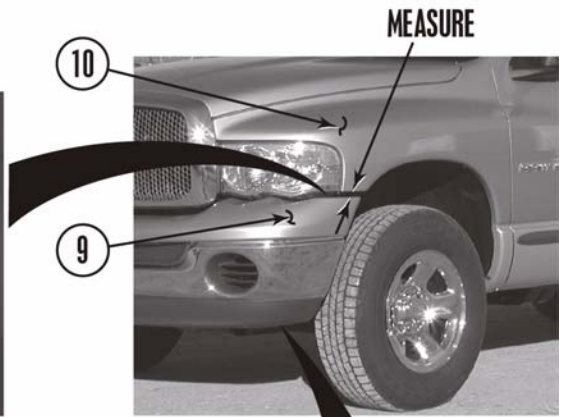

b. If so equipped, remove two connectors (11) from two running lights (12).

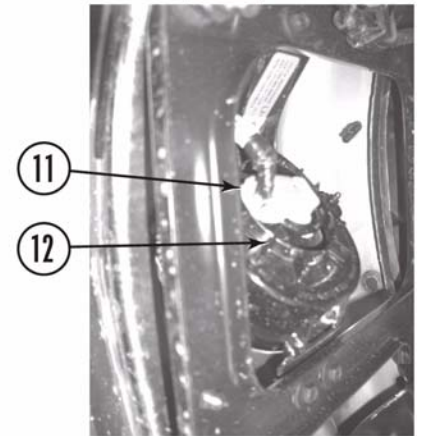

c. Remove four nuts with captive washers (13), two double bolt fasteners (14), and front bumper (9) from frame (15).

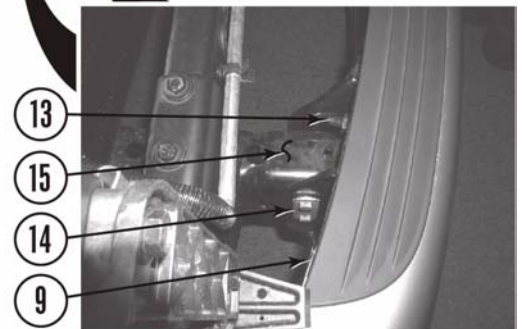

2. Under the hood.

Air intake.

a. Remove clamp (16), hose (17), air intake (18), four clips (19), and air box cover (20) from throttle body (21) and air filter housing (22).

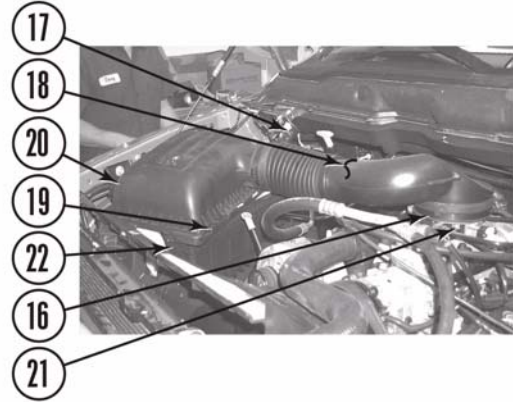

Radiator shroud.

a. Remove bolt (23), hose (24), and overflow bottle (25) from fan shroud (26).

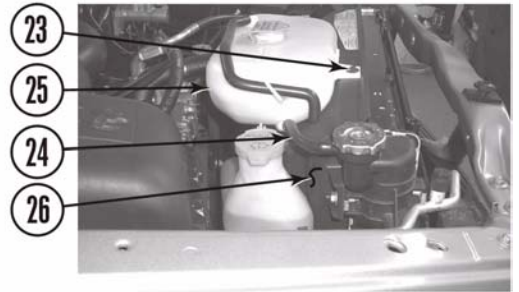

b. Remove two connectors (27) from window washer spray bottle (28).

c. Remove washer bottle hose (29) from junction (30) and drain window washer spray bottle (28) into suitable container. Remove window washer spray bottle from fan shroud (26).

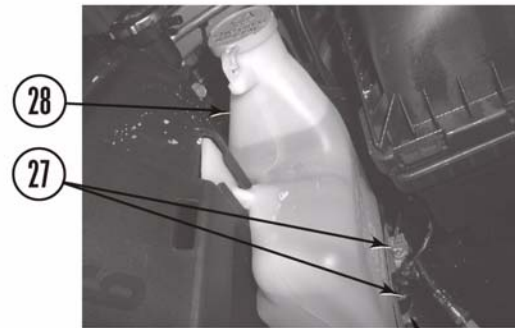

d. Remove four bolts (31) and rest cooling fan (32) back on cooling fan shaft (33).

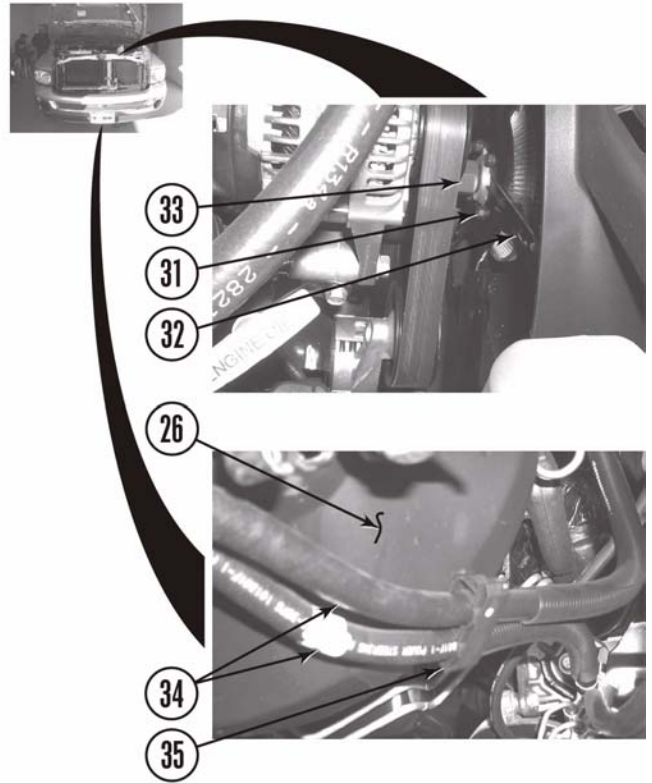

e. Remove two lines (34) from clip (35) and clip from fan shroud (26).

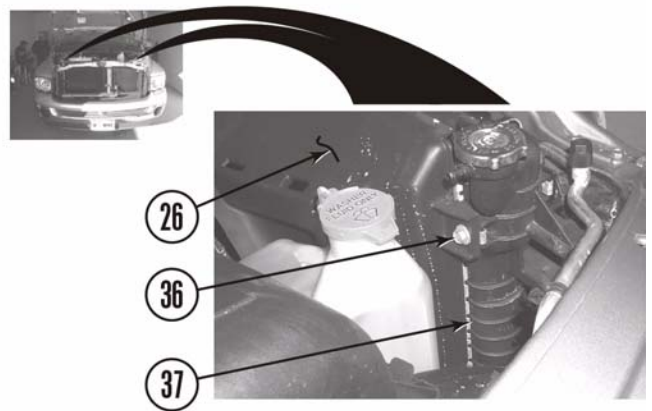

f. Hold upper radiator hose (38) out of way and remove fan shroud (26) from vehicle.

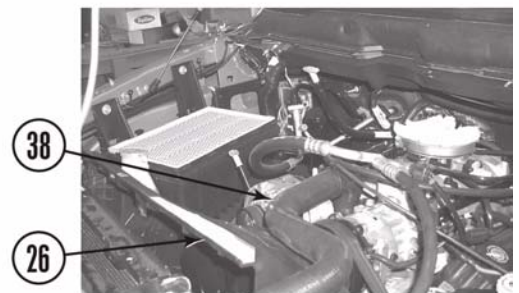

g. Remove bolt with captive washer (39), clip (40) and two lines (41) from engine block (42).

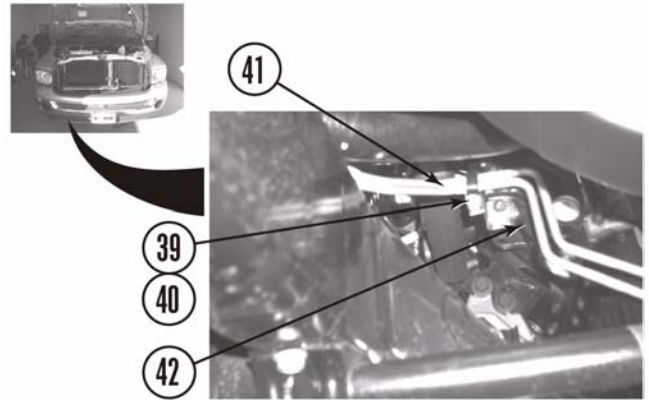

3. Steering.

NOTE
 Ensure steering shaft does not turn independently of the steering gearbox. This could cause the air bag system to malfunction, resulting in serious personal injury or damage to the equipment.

a. Straighten steering wheel and strap wheel so it will not turn.

b. Remove bolt (43) and slide upper steering shaft (44) up to separate from rack and pinion shaft (45). Upper shaft may not separate from steering rack shaft until lift blocks are installed.

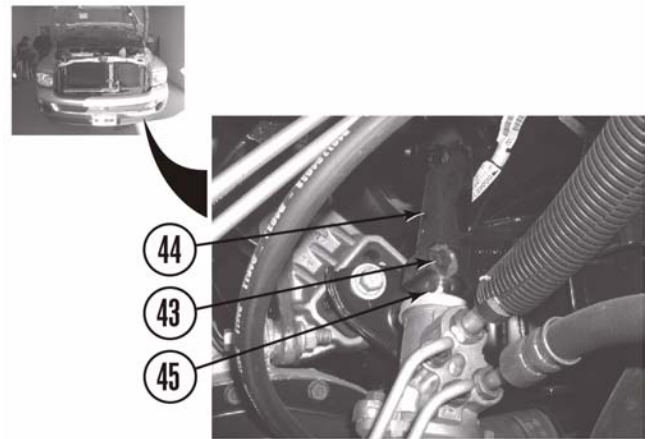

c. Remove nut (46) and ground strap (47) from stud (48) on firewall (49).

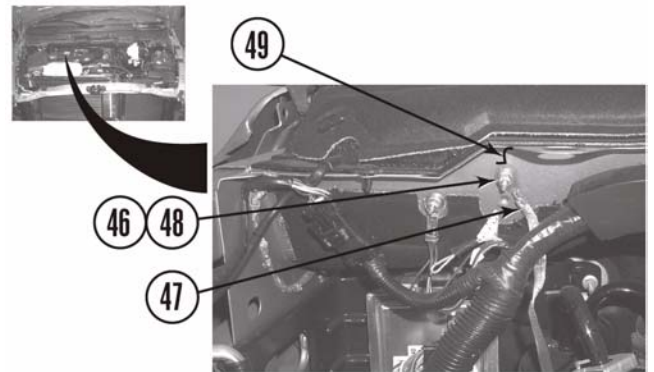

4. Along the frame rails/under cab.

a. Remove bolt with captive washer (50) and ground strap (51) from frame (15) driver side.

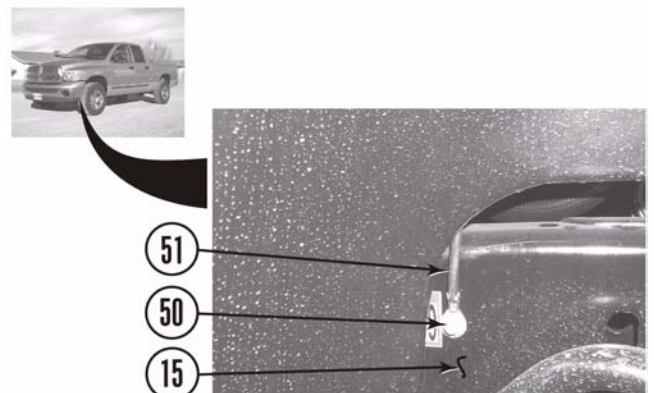

- b. Remove clip (52) and harness (53) from frame (15) driver side.
- c. Remove clip (54) from two lines (55).
- d. Remove shifter cable (56) from clip (57).

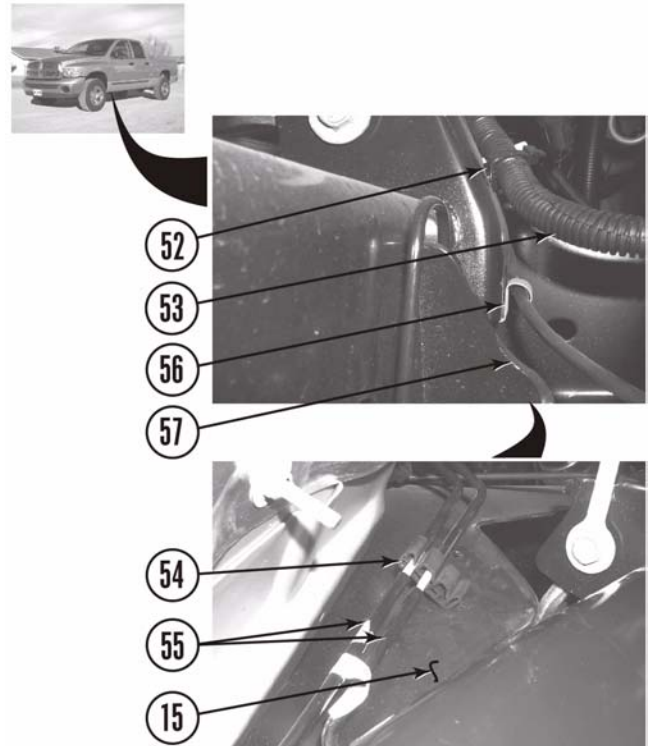

- e. Pull some slack in front parking brake cable (58) and clamp cable at driver side frame mount (59) with a vicegrip.
- f. Separate front parking brake cable (58) from rear parking brake cable (60).
- g. Remove front parking brake cable (58) from driver side frame mount (59).

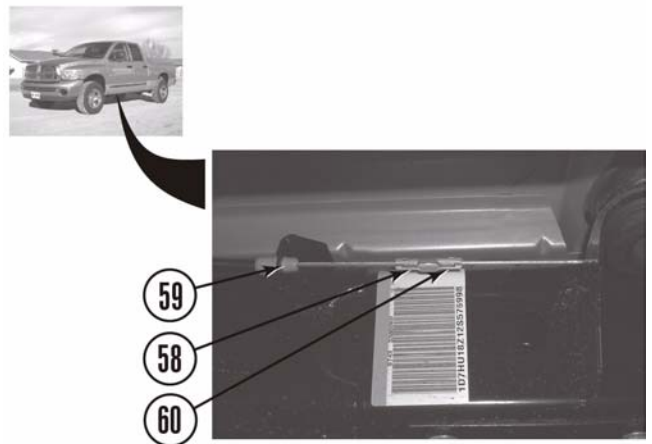

⚠WARNING
 Use extreme caution when working near fuel lines and fuel tank. Clean up spilled fuel immediately. Any spark could cause an explosion or fire resulting in serious personal injury and property damage.

- 5. Remove the fuel filler.
 - a. Remove gas cap (61) from fuel filler (62).
 - b. Remove three bolts (63) from bed (64) and fuel filler (62).

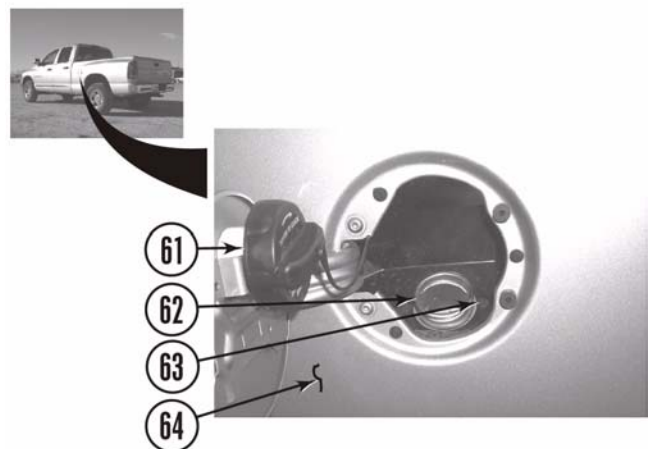

6. Remove the rear bumper.

a. Measure distance between rear bumper (65) and tailgate (66).

b. Disconnect two connectors (67) from license plate lights (68).

c. Disconnect four screws (69) and license plate (70) from rear bumper (65).

d. Pull hitch electrical connector (71) out of rear bumper (65). Remove red locking tab (72) from hitch connector. Press tab and disconnect hitch connector from harness (73).

e. Remove two bolts (74) and nut fasteners (75) from two rear bumper brackets (76) and frame (15).

f. If equipped with a trailer hitch (77), remove two bolts (78) and rear bumper (65) from hitch.

g. If not equipped with a trailer hitch, remove two bolts (78) and rear bumper (65) from frame (15).

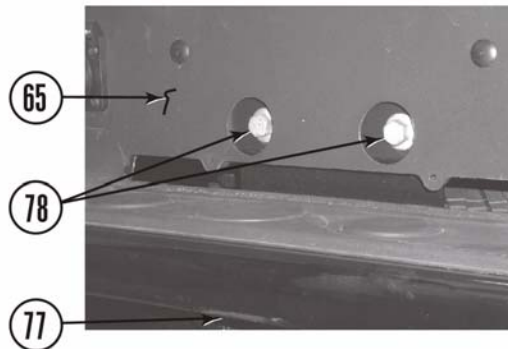
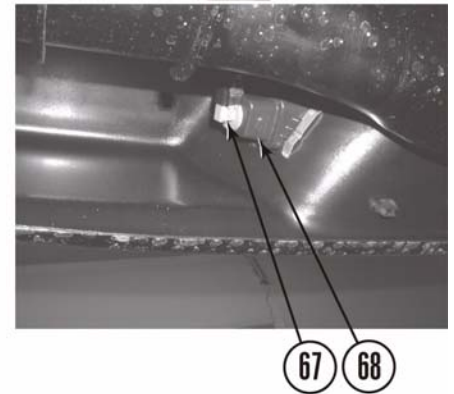
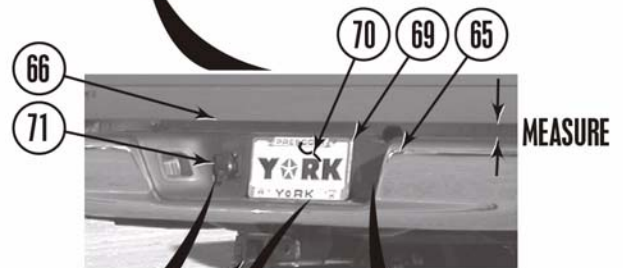
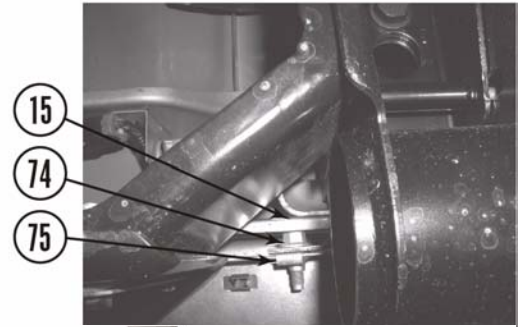

h. Remove two nuts (79) and bolt fasteners (80) from two rear bumper brackets (76) and frame (15).

i. Remove four nuts (79) and two double bolt fasteners (81) from two rear bumper brackets (76) and frame (15).

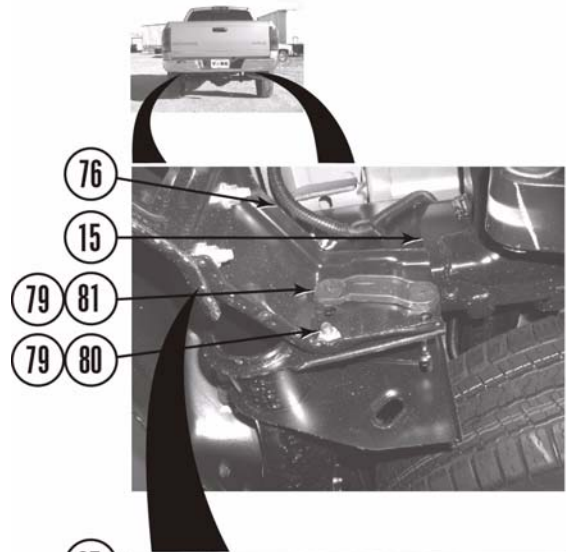

j. Remove two nuts (82), double bolt fasteners (83), and rear bumper brackets (76) from rear bumper (65).

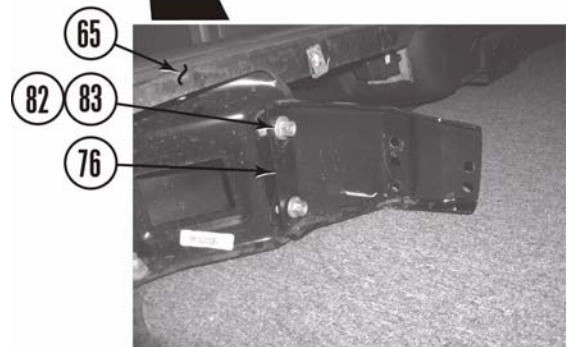

7. Spare tire.

a. Lower spare tire to the ground (see owner's manual).

b. Remove clip (84) and ratchet tube (85) from spare tire crank mechanism (86).

c. Remove two bolts (87) and spare tire crank mechanism (86) from crossmember (88).

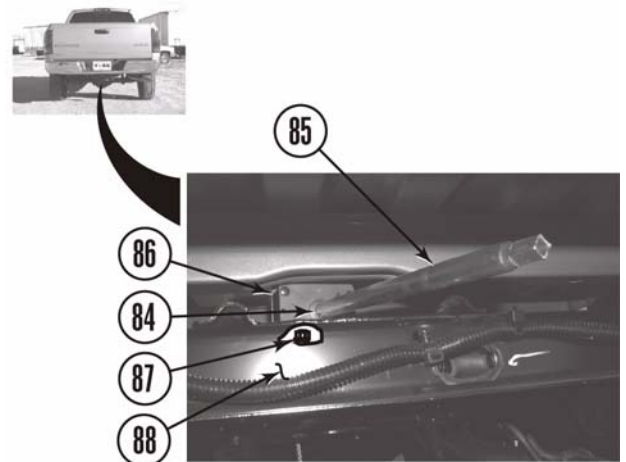

8. Manual transmission - remove shift lever.

NOTE

Steps 8. through 10. are for manual transmission vehicles only. Steps 11 through 13. pertain to manual 4wd vehicles only. Automatic transmission/transfer case vehicles skip these steps.

- a. Shift transmission extension shift lever (1) into neutral.
- b. Remove four screws (2) from boot (3) and console (4) and slide boot up on transmission extension shift lever (1).
- c. Unscrew transmission extension lever (1) from shift tower lever (5).
- d. Remove four bolts (6) and shift tower (7) from transmission (8).
- e. Remove rubber cover (9) from shift tower (7).
- f. Remove four screws (10), plate (11), and shim(s) (12) from shift tower (7).
- g. Remove shift tower lever (13) from shift tower (7).
- h. Remove two plastic shift tabs (14) and plastic ball end locator (15) from shift tower lever (13).

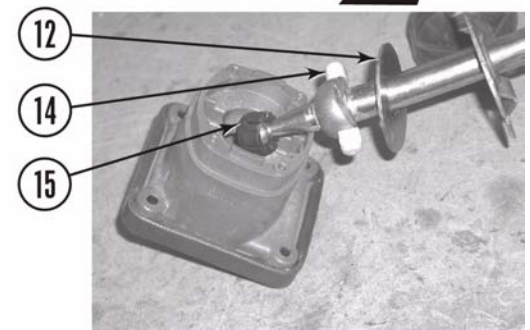
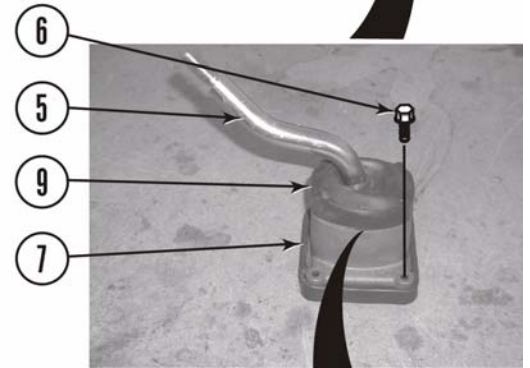
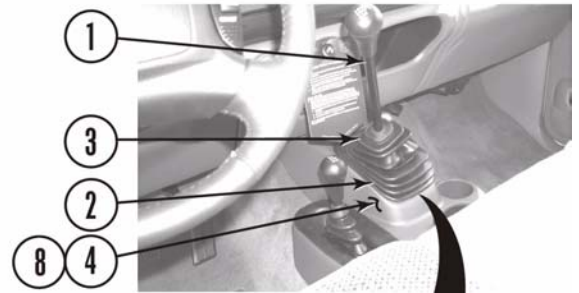

⚠WARNING

Be careful not to damage any of the parts attached to the shift levers during cutting and welding or damage to the equipment could result. A certified welder should perform all welding.

9. Lengthen transmission shift lever.

a. Scribe a line along the side of the shift tower lever (13) (below the lowest bend) as shown. Cut the lever into two pieces through the line and deburr as necessary.

b. Position *kit* shift lever extension (16) between the two pieces of the shift tower lever (13). Ensure the extension and lever scribed lines align and weld the extension in place.

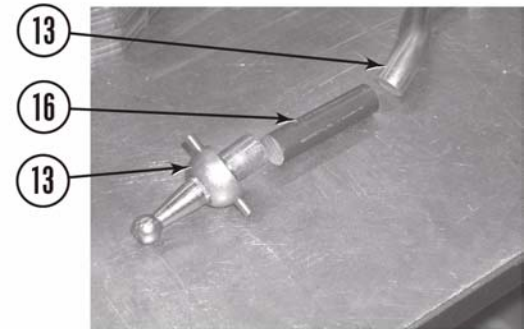

10. Install transmission shift lever.

a. Install two plastic shift tabs (14) and plastic ball end locator (15) on shift tower lever (13).

b. Install shim(s) (12) and plate (11) on shift tower (7) with four screws (10).

c. Install rubber cover (9) on shift tower (7).

d. Install shift tower (7) on transmission (8) with four bolts (6).

e. Install transmission extension lever (1) on shift tower lever (5).

f. Install boot (3) on console (4) with four screws (2).

g. Check transmission shift lever operation. Ensure there is complete engagement in all gears.

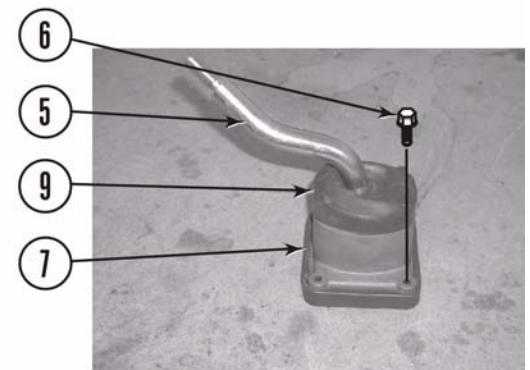
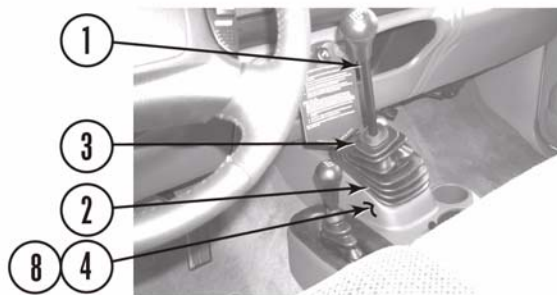
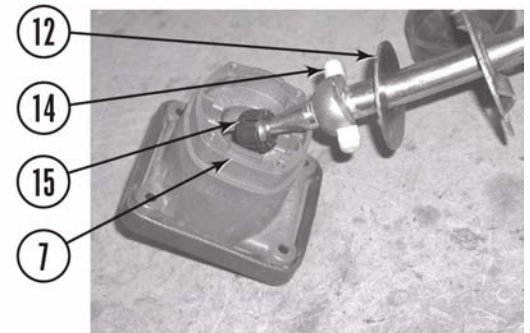

11. Manual 4wd - remove shift rod.

- a. Move 4wd shift lever (17) into 2H position.
- b. Remove bolt (18) from trunnion (19).
- c. Remove trunnion (19) from lower shift lever (20) and shift rod (21).
- d. Remove shift rod (21) from transfer case input lever (22).

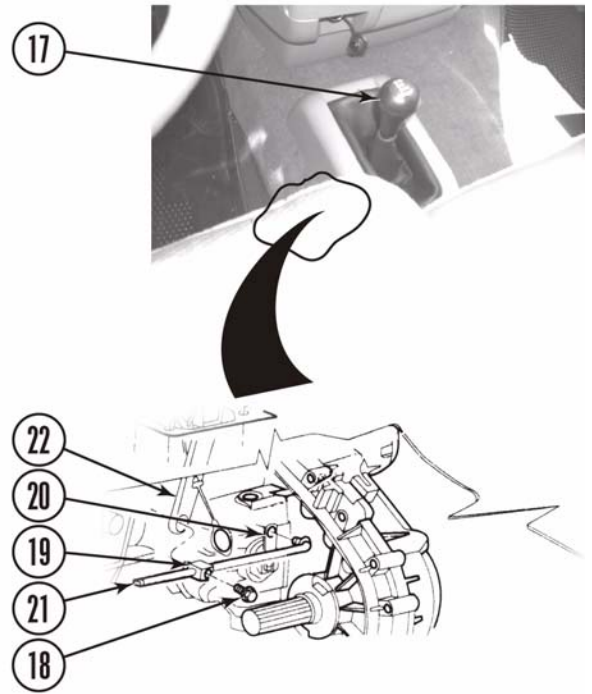

12. Lengthen shift rod.

- e. Scribe a line along the side of the shift rod (21) as shown. Cut the lever into two pieces through the line and deburr as necessary.
- f. Position *kit* 4wd shift rod extension (22) between the two pieces of the shift rod (21). Ensure the extension and lever scribed lines align and weld the extension in place.

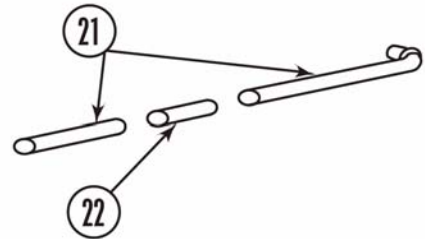

13. Install shift rod.

- g. Install shift rod (21) in transfer case input lever (22).
- h. Install trunnion (19) on shift rod (21) and lower shift lever (20).
- i. Install bolt (18) in trunnion (19).
- j. Check 4wd shift lever operation. Ensure there is complete engagement in all ranges. It may be necessary to adjust position of trunnion on shaft to achieve this.

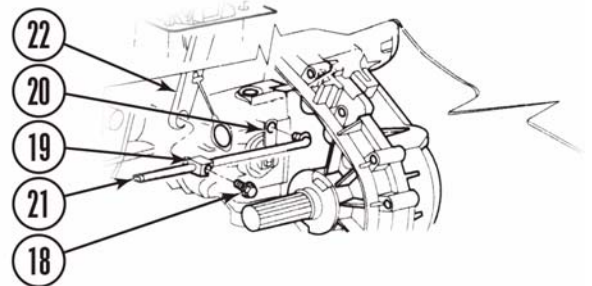

C. Install the kit.

1. Prepare to lift cab from frame.

⚠WARNING

Failure to replace the OEM cab mounting hardware (except mounting bolts in the kit) in the stock locations could result in serious personal injury or damage to the vehicle.

⚠NOTE

Depending on model year, some washers used with cab bolts may be captive washers and some may be standard washers. Standard washers are to be used during reassembly.

- a. Measure distance between cab (89) and bed (64). Record measurement for later reference.
- b. Loosen but do not remove two core support bolts (90) from core support mounting pads (91).
- c. Loosen but do not remove six (four on a single cab) cab mounting bolts (92).

⚠WARNING

Use extreme caution when lifting cab from frame. Ensure lifting device is securely placed. Keep hands out from between frame and cab, or serious personal injury could result.

⚠CAUTION

Continually check hoses, wires, lines, etc. to be sure that everything is flexing properly and not binding, or damage to the vehicle could result. Be especially careful of the a/c hoses at the firewall, the belt pulley, and at the core support. Ensure brake lines stretch while lifting. Bending the lines to gain ample slack may be necessary. Be extremely careful not to kink the lines.

⚠NOTE

Ensure stock spacers and cab mounting pads stay on vehicle unless otherwise specified in these instructions. *Kit* spacer blocks are installed in addition to the stock spacers and cab mounting pads.

- d. Remove core support bolt (90) and bottom bushing (93) from passenger side frame mounting pad (94) and passenger side core support mounting pad (91).
- e. Remove three bolts (92), bottom bushings (93), and two rear bottom bushing washers (95 and 96) from the passenger side frame mounting pads (94) and cab (89).

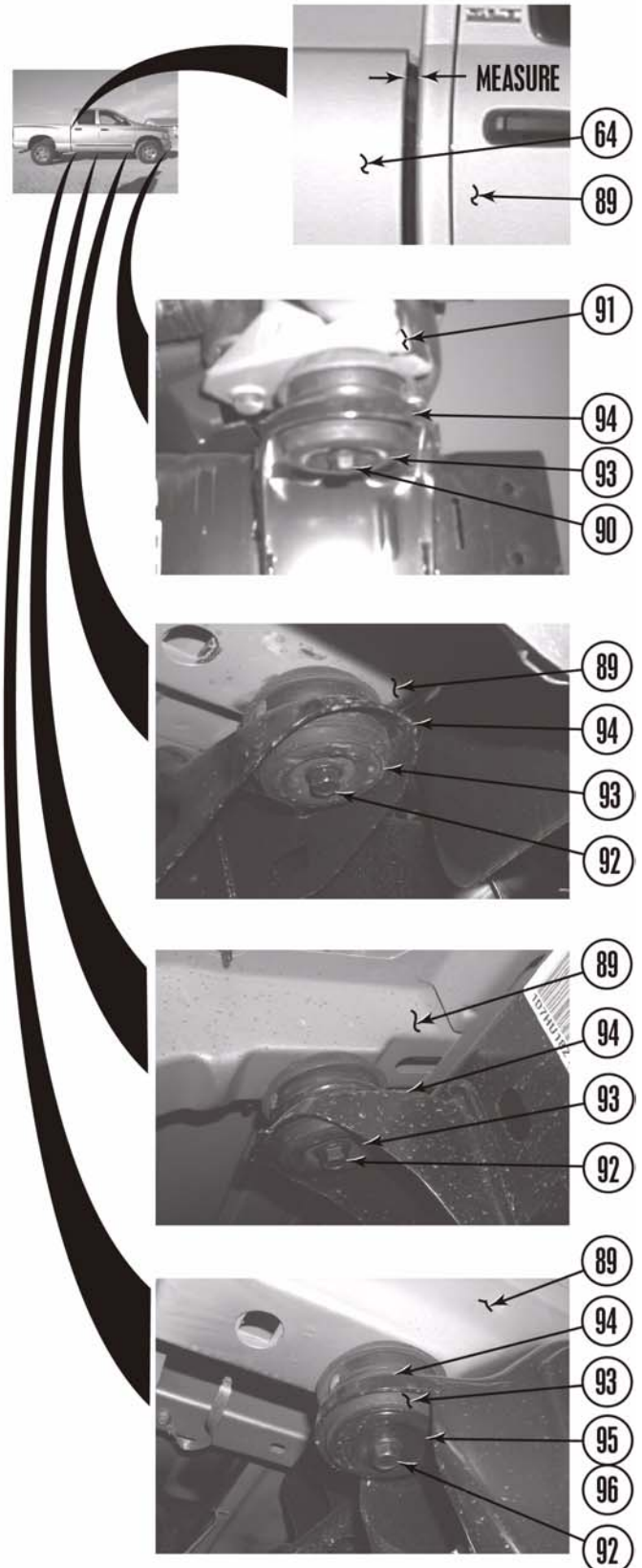

2. Lift cab and install cab passenger side spacer blocks.

a. Using a hydraulic jack and a wooden block, slowly lift the cab (89) passenger side just high enough to position a *kit* 3" x 3" spacer block (97) between the metal cup (98) and the passenger side core support mounting pad (91).

b. Position three *kit* 3" x 3" spacer blocks (97) on top of the passenger side frame mounting pads (94).

c. Install a *kit* 12mm x 1.75 x 180mm bolt (99) through *kit* 7/16" USS washer (100), bottom bushing (93), frame mounting pad (94), top bushing (101), metal cup (102), *kit* spacer block (97), and cab passenger side core support mounting pad (91). Do not tighten.

d. Install three *kit* 12mm x 1.75 x 180mm bolts (99) through three *kit* 7/16" USS washers (100), two rear bushing washers (95 and 96), bottom bushings (93), frame mounting pads (94), top bushings (101), metal cups (102), *kit* spacer blocks (97), and cab (89). Do not tighten.

e. Lower cab (89) on the *kit* spacer blocks (97).

3. Install the cab driver's side spacer blocks.

a. Repeat steps C. 1. c. and d. and C. 2. a. through e. for the cab driver's side.

4. Finish the cab spacer block installation.

a. Remove eight bolts (99) one at a time, coat threads with Loctite® and reinstall. Check cab (89) alignment to bed (64) and tighten to 55 lb-ft.

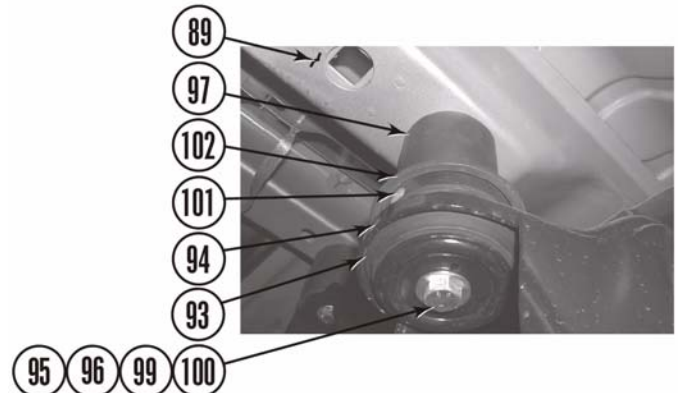
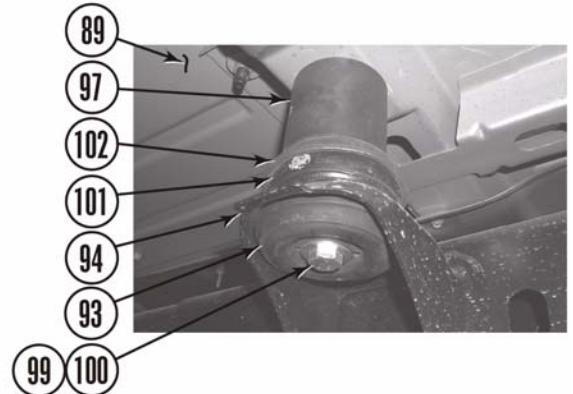
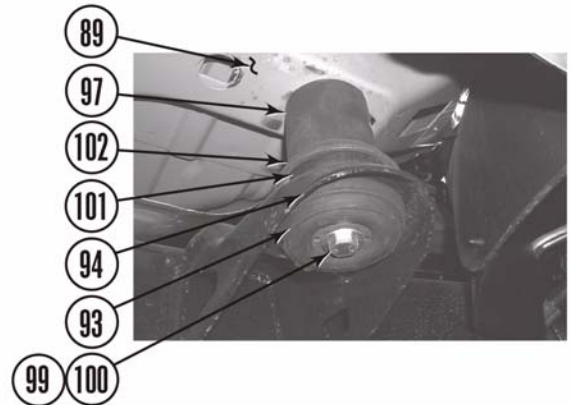
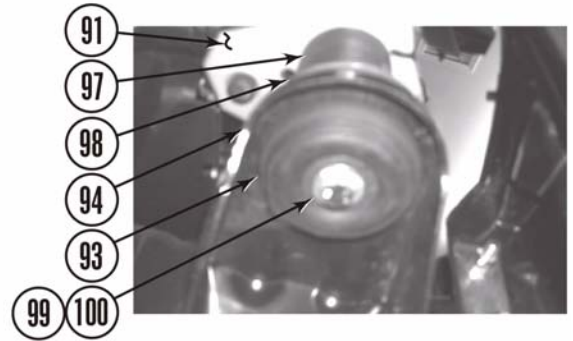

5. Install the bed passenger's side spacer blocks.

a. Loosen but do not remove six (eight on a long bed) bed mounting bolts (103) from frame mounting pads (94) and bed (64).

b. Remove three bed mounting bolts (103) from frame mounting pads (94) and bed (64) passenger's side.

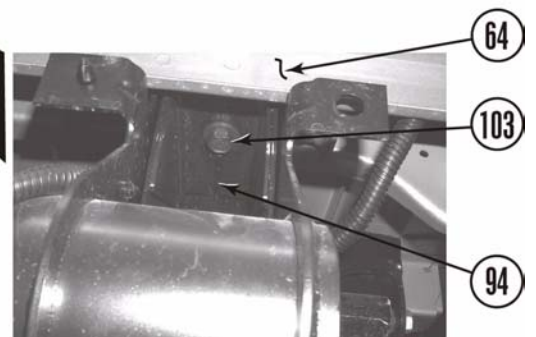
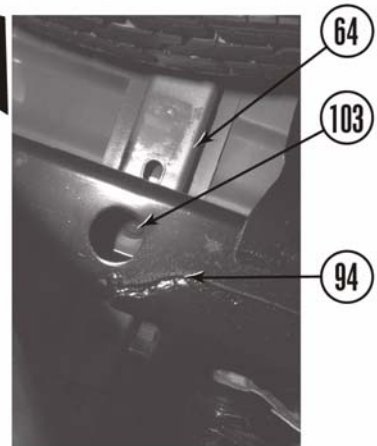
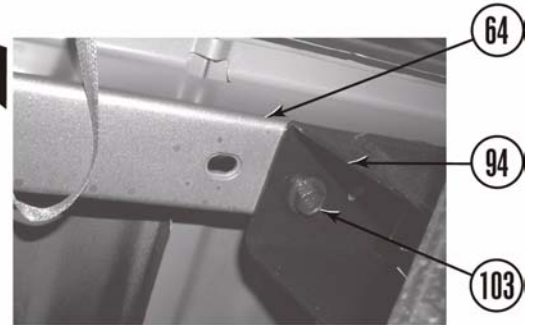

c. Using a hydraulic jack and a wooden block, slowly lift the bed (64) passenger's side just high enough to position three *kit* 2" x 3" spacer blocks (97) on frame mounting pads (94).

d. Install three *kit* 12mm x 1.75 x 100mm bolts (104) through three *kit* 7/16" USS washers (105), frame mounting pads (94), *kit* 3" x 3" spacer blocks (97), and bed (64). Do not tighten.

e. Lower the bed (64) onto the spacer blocks (97).

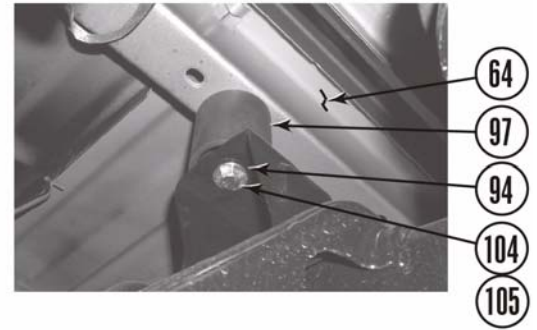

6. Install the bed driver's side spacer blocks.

a. Repeat steps C. 5 a. through e. for the bed driver's side.

7. Finish the bed spacer block installation.

a. Adjust the cab to bed clearance using the measurements from step C. 1. a.

b. Remove six bed mounting bolts (104) one at a time, coat threads with Loctite®, and reinstall. Tighten to 55 lb-ft.

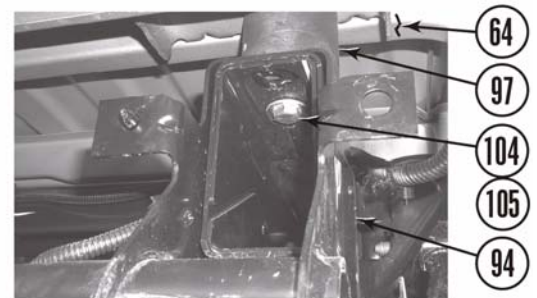

⚠WARNING

Use extreme caution when working near fuel lines and fuel tank. Clean up spilled fuel immediately. Any spark could cause an explosion or fire resulting in serious personal injury and property damage.

8. Install fuel filler.

- a. Remove two clamps (107 and 108), filler hose (109), and vent hose (110) from gas tank (111) and vehicle.
- b. Carefully cut filler hose (109) and vent hose (110) in half where shown.
- c. Install *kit* extension (112) on filler hose (109) with two *kit* #36 clamps (113).
- d. Install *kit* extension (114) on vent hose (110) with two *kit* #10 clamps (115).

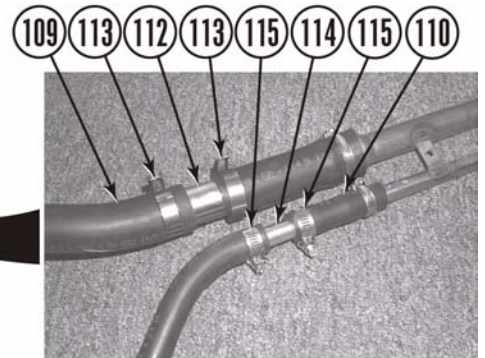
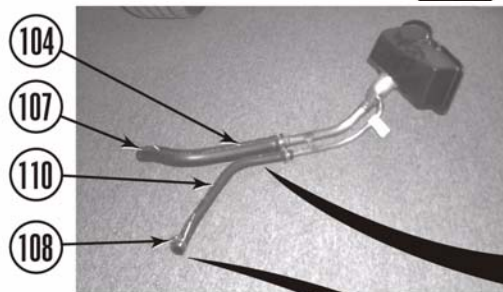
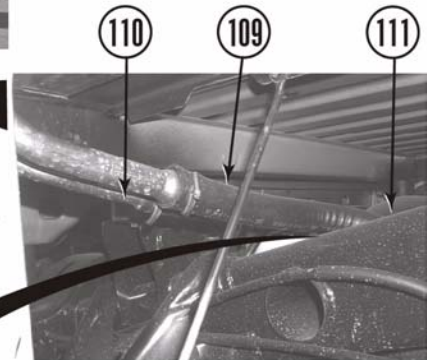

- e. Install filler hose (109) and vent hose (110) on gas tank (111) with two clamps (107 and 108).

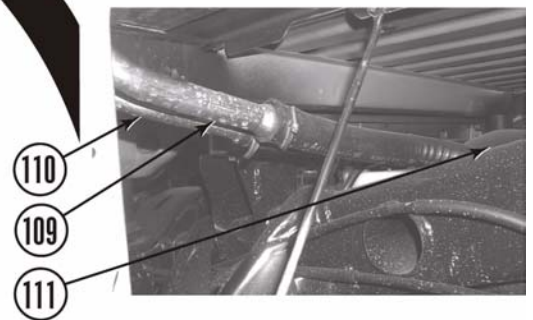

- f. Install fuel filler (62) on bed (64) with three bolts (63).
- g. Install gas cap (61).

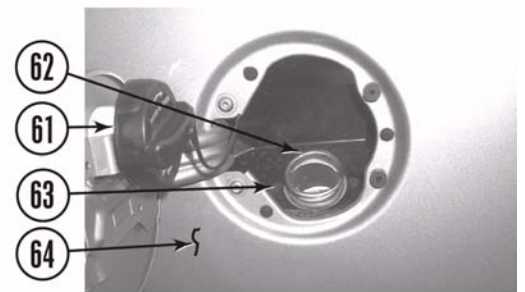

9. Along the frame rails/under cab.

a. Using *kit* parking brake bracket (116), as a template, mark and drill a 5/16" hole in the bottom of the driver side frame mount (59).

b. Install *kit* parking brake bracket (116) on driver side frame mount (59) with *kit* 5/16" x 1" bolt (117), two *kit* 5/16" USS washers (118), *kit* 5/16" nylock nut (119), *kit* 7/16" x 1" bolt (120), two *kit* 7/16" USS washers (100), and *kit* 7/16" nylock nut (121).

c. Route front parking brake cable (58) through biggest hole in *kit* parking brake bracket (116) and reconnect front cable to rear cable (60).

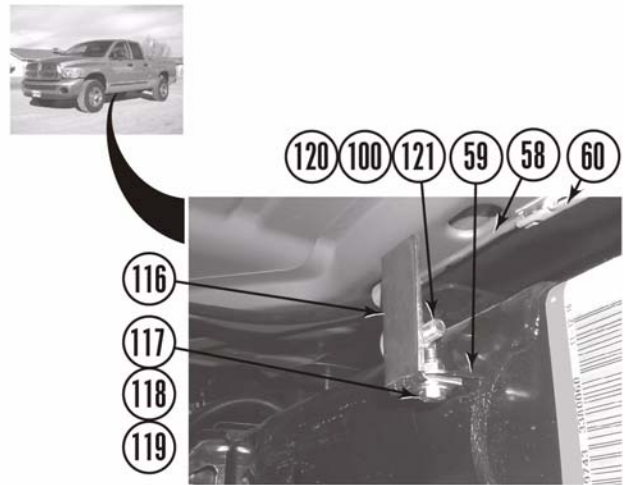

d. If possible, install shifter cable (56) in clip (57).

e. If possible, install clip (54) on two lines (55).

f. If possible, install clip (52) and harness (53) on frame (15) driver side.

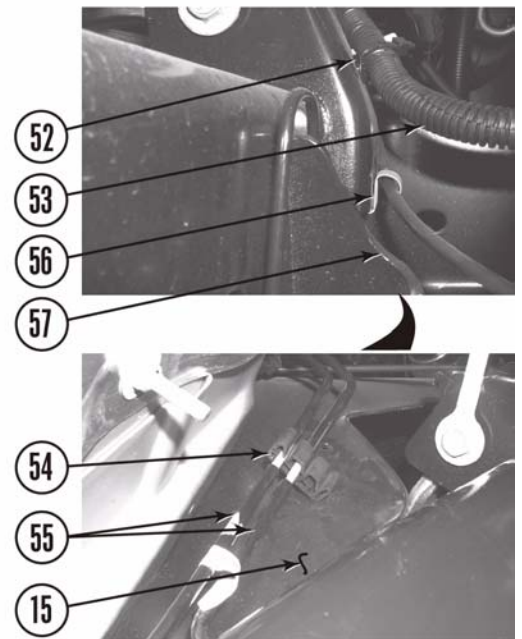

g. Install *kit* ground strap extension bracket (122) on frame (15) driver side with bolt with captive washer (50).

h. Install ground strap (51) on *kit* ground strap extension bracket (122) with *kit* 1/4" x 1" bolt (123), two *kit* 1/4" SAE washers (124), and *kit* 1/4" nylock nut (125).

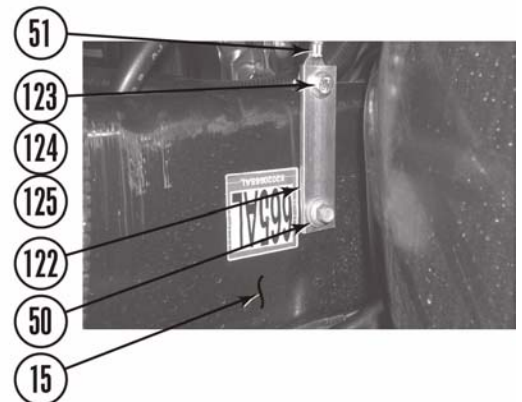

10. Under the hood.

a. Install *kit* bracket (126) on stud (48) on firewall (49) with nut (46).

b. Install ground strap (47) on *kit* bracket (126) with *kit* 1/4" x 1" bolt (123), two *kit* 1/4" SAE washers (124), and *kit* 1/4" nylock nut (125).

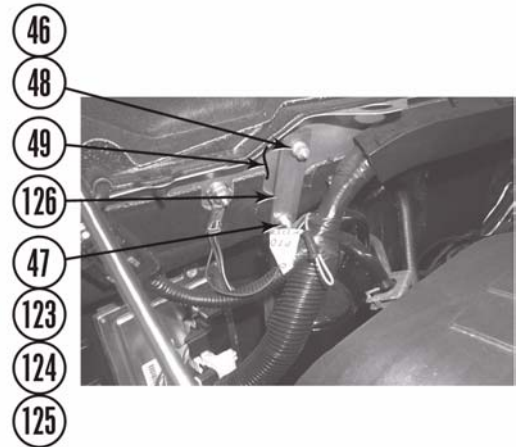

c. Install clip (40) and two lines (41) on engine block (42) with bolt with captive washer (39).

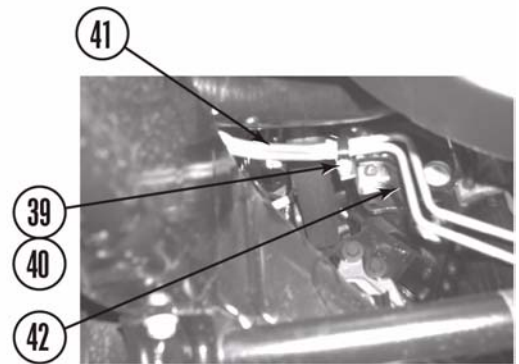

11. *Kit* steering extension.

a. Coat threads of retaining bolts (43 and 128) with Loctite®.

b. Install *kit* steering extension (127) on rack and pinion shaft (45) with *kit* 3/8" x 1 1/4" socket head bolt (128). Do not tighten.

c. Install upper steering shaft (44) on *kit* steering extension (127) with the stock retaining bolt (43).

d. Tighten bolts (43 and 128) to 33 lb-ft.

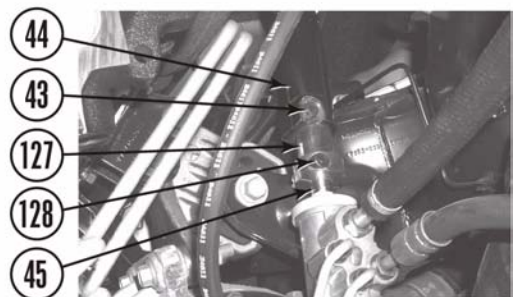

Radiator shroud.

- a. Mark a cut line on the fan shroud (26) as shown. Ensure cut line is exactly as marked.
- b. Cut fan shroud (26) in half on cut lines.

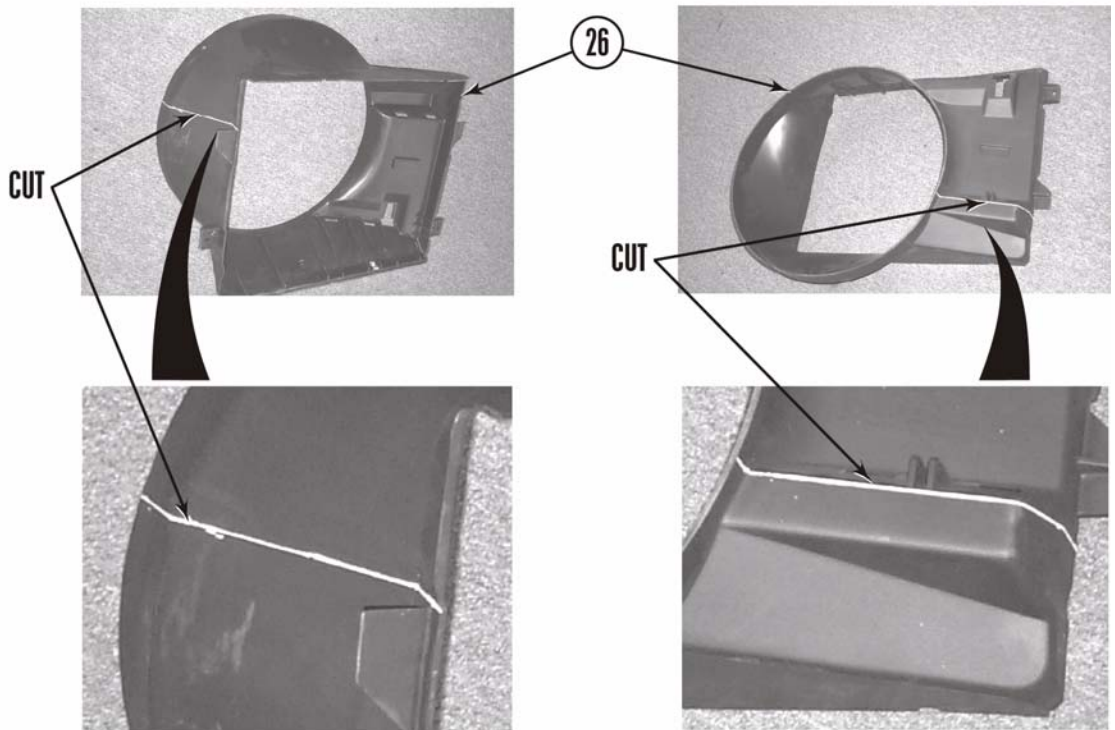

- c. Position *kit* passenger side fan shroud bracket (129) on top half (130) of cut fan shroud as shown.
- d. Using *kit* passenger side fan shroud bracket (129) as a template, mark and drill five 1/4" holes as shown.
- e. Install *kit* passenger side fan shroud bracket (129) on top half (130) of fan shroud with five *kit* 1/4" x 1" bolts (123), ten *kit* 1/4" SAE washers (124), and five *kit* 1/4" nylock nuts (125). Ensure bolt heads are facing as shown.
- f. Position *kit* driver side fan shroud bracket (131) on top half (130) of cut fan shroud as shown.
- g. Using *kit* driver side fan shroud bracket (131) as a template, mark and drill five 1/4" holes as shown.
- h. Install *kit* driver side fan shroud bracket (131) on top half (130) of fan shroud with five *kit* 1/4" x 1" bolts (123), ten *kit* 1/4" SAE washers (124), and five *kit* 1/4" nylock nuts (125). Ensure bolt heads are facing as shown.

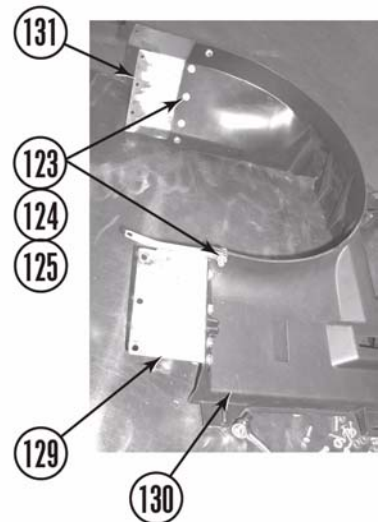

i. Position bottom half (132) of cut fan shroud on *kit* passenger side fan shroud bracket (129) and measure three inches between cuts.

j. Using *kit* passenger side fan shroud bracket (129) as a template, mark and drill four 1/4" holes as shown.

k. Install *kit* passenger side fan shroud bracket (129) on bottom half (132) of fan shroud with four *kit* 1/4" x 1" bolts (123), eight *kit* 1/4" SAE washers (124), and four *kit* 1/4" nylock nuts (125). Ensure bolt heads are facing as shown.

l. Position *kit* driver side fan shroud bracket (131) on bottom half (130) of cut fan shroud and measure three inches between cuts.

m. Using *kit* driver side fan shroud bracket (131) as a template, mark and drill five 1/4" holes as shown.

n. Install *kit* driver side fan shroud bracket (131) on bottom half (132) of fan shroud with five *kit* 1/4" x 1" bolts (123), ten *kit* 1/4" SAE washers (124), and five *kit* 1/4" nylock nuts (125). Ensure bolt heads are facing as shown.

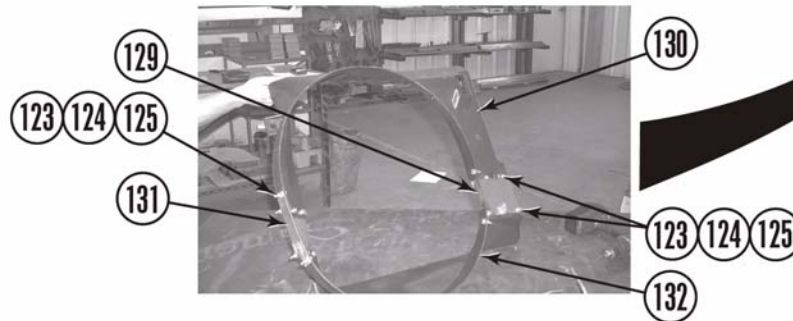
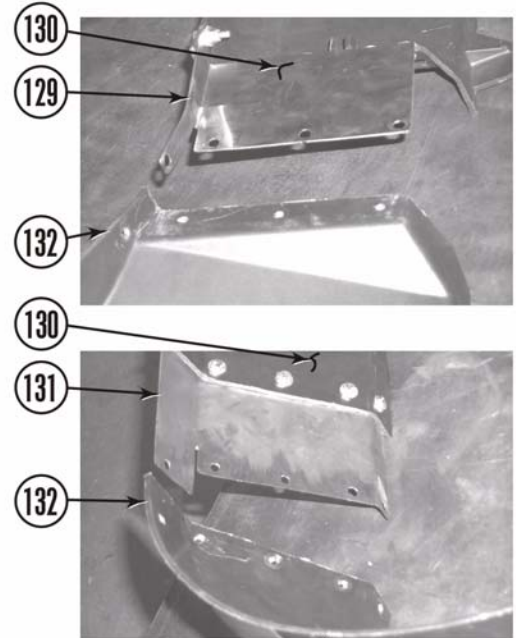

o. Remove two nuts (133), lockwashers (134), screws (135), transmission cooler brackets (136) and transmission cooler (137) from radiator (37). Do not disconnect lines.

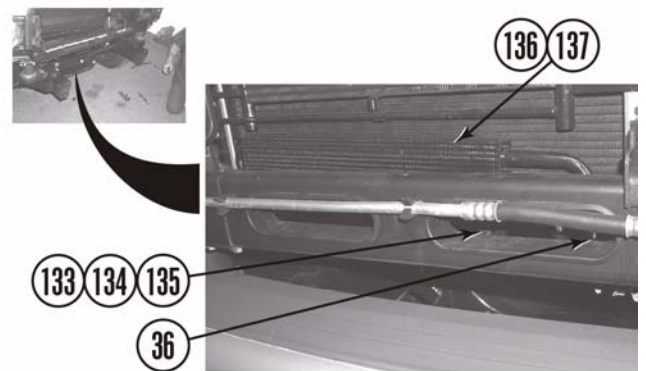

p. Position fan shroud (26) on radiator (37). Ensure fan shroud tabs (138) are fully in slots (139) on radiator and install two bolts with captive washers (36).

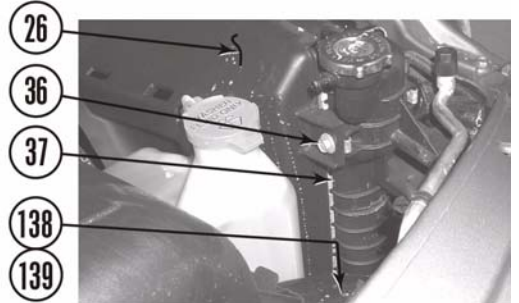

q. Install cooling fan (32) on cooling fan shaft (33) with four bolts (31).

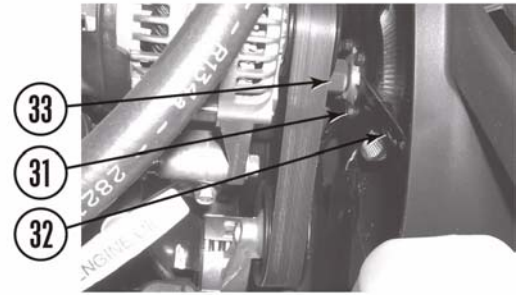

r. Install washer spray bottle (28) on fan shroud (26) and connect washer bottle hose (29) to junction (30).



s. Install two connectors (27) on window washer spray bottle (28).



t. Position overflow bottle (25) on radiator shroud (26) and install bolt (23) and hose (24). Refill overflow bottle.

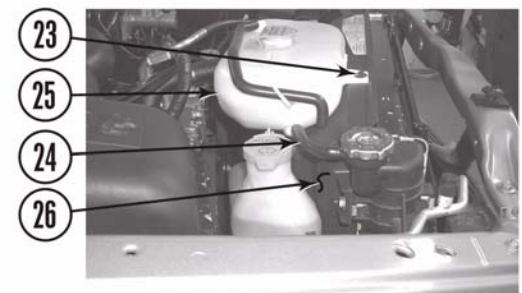

u. Position two *kit* 1 1/2" tube spacers (138) in bottom of radiator (37) as shown.

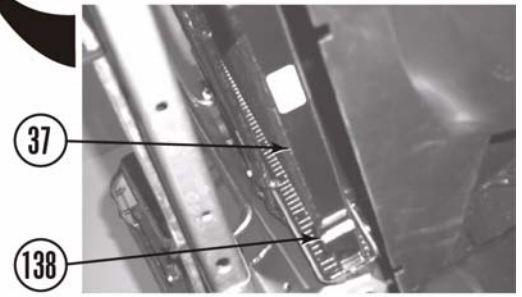

v. Install two *kit* s-brackets (139) on transmission cooler brackets (136) with two 1/4" SAE washers (124), and two 1/4" nylock nuts (125).

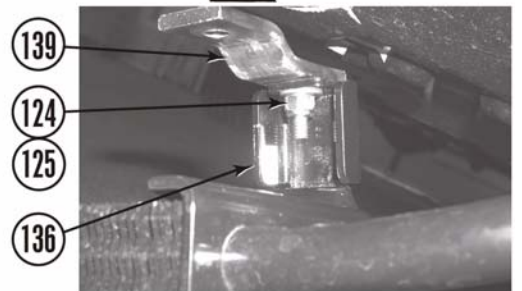

w. Install two *kit* s-brackets (139) on radiator (37) with two bolts (135), lockwashers (134), and nuts (133).

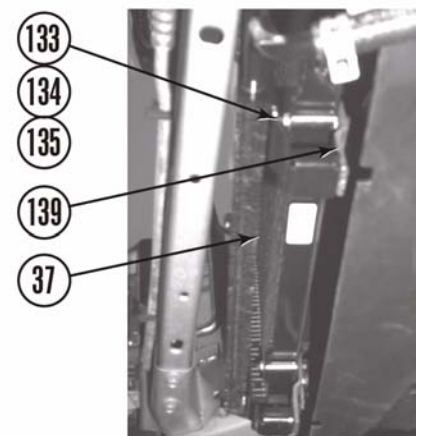

Air intake.

- a. Install air intake (18) on throttle body (21) with clamp (16). Install hose (17).
- b. Install air box cover (20) on air filter housing (22) with four clips (19).

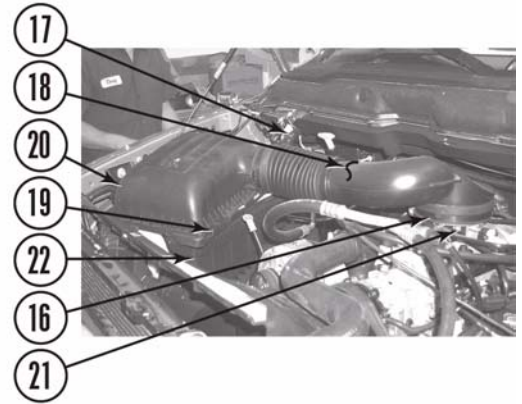

12. Install the front bumper.

- a. Trim two front frame horns (140) as shown.

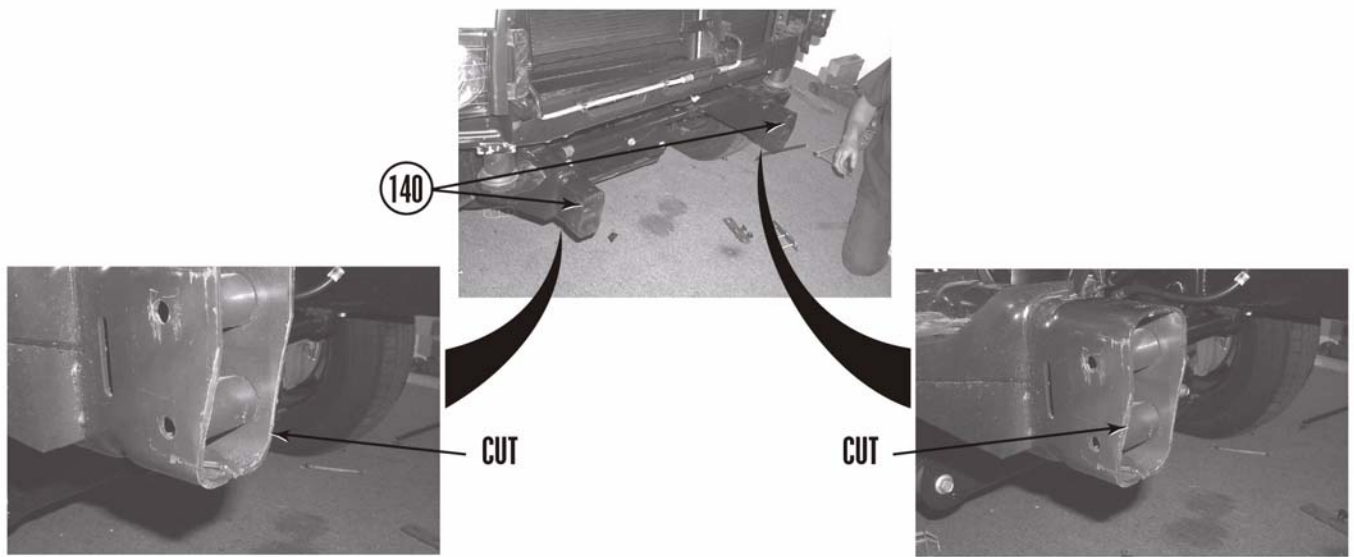

- b. Trim two front bumper brackets (141) as shown.

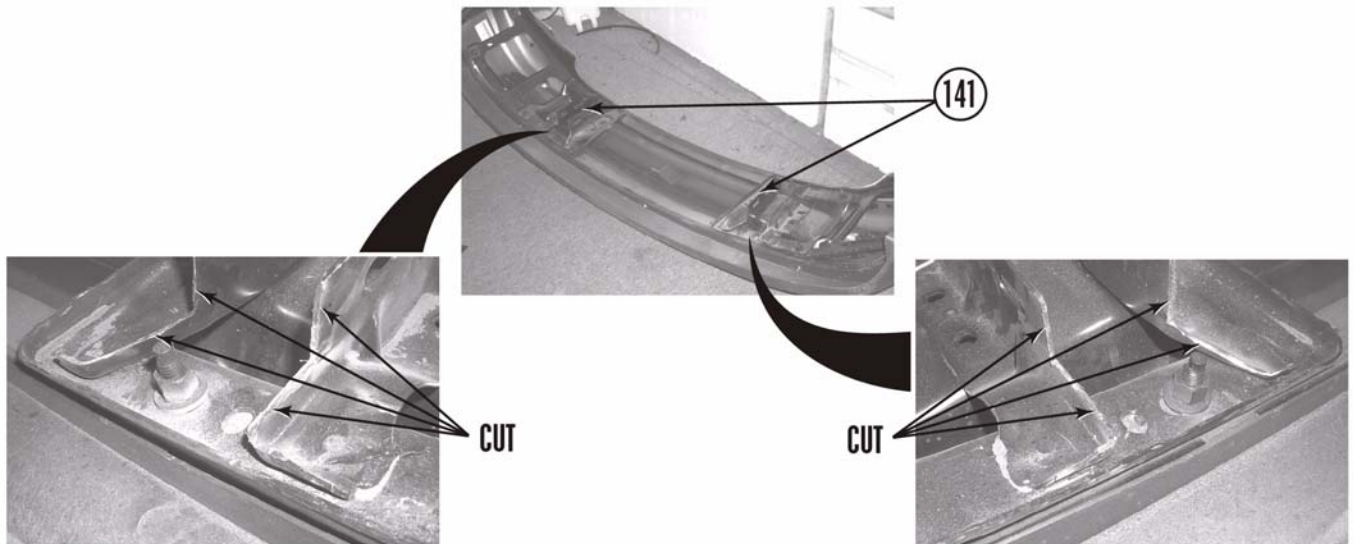

c. Coat threads of nuts (13 and 121) and bolts (14 and 145) with Loctite®.

△NOTE

Steps d. through g. require two people - one to position and hold the front bumper and another to install the brackets and hardware.

d. Position front bumper (9) on frame (15). Ensure front edges of wheel wells (142) engage in slots on sides of front bumper and raise bumper until bottom holes on front bumper brackets (141) align with top holes on frame (15).

e. Install four *kit* bumper brackets (143), two double bolt fasteners (14), and four nuts with captive washers (13) through *kit* bumper brackets and frame (15). Do not tighten.

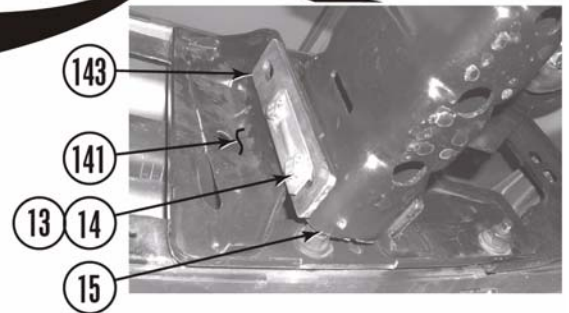
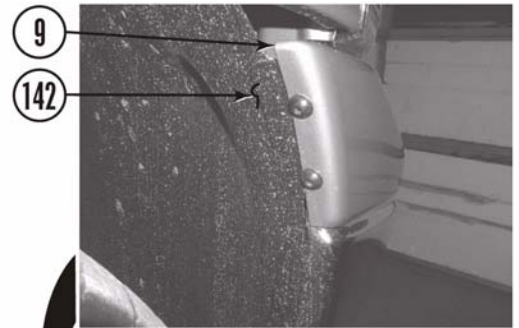
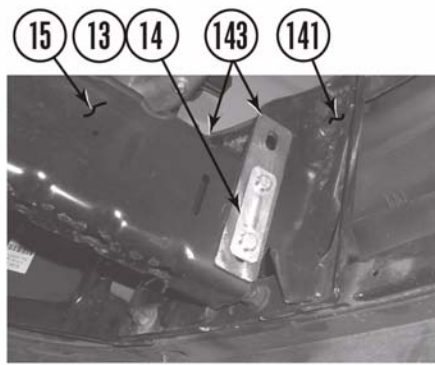

f. Install two *kit* 2 3/4" tube spacers (144) between top holes of four *kit* bumper brackets (143) with two *kit* 12 x 120mm bolts (145), eight *kit* 7/16" USS washers (100), and two *kit* 12 nylock nuts (121). Do not tighten.

g. Tighten nuts (13 and 121) and bolts (14 and 145). Check measurements between front bumper (9) and front fenders (10). Adjust bumper to cab clearance and tighten bolts and nuts to 55 lb-ft.

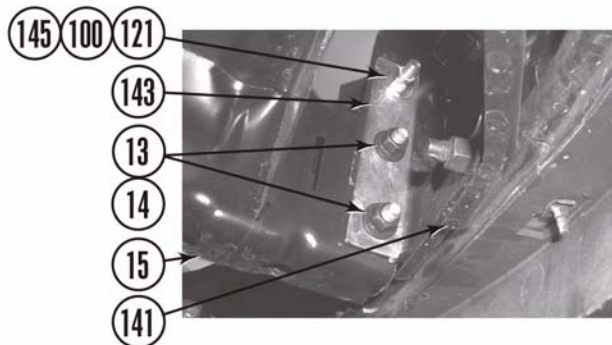
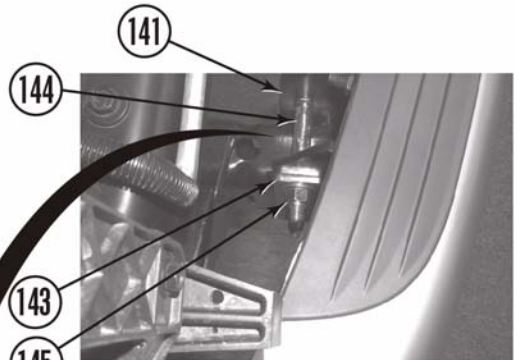

13. Spare tire carrier.

a. Position *kit* spare tire carrier (146) on crossmember (87) as shown and start driver side bolt (86).

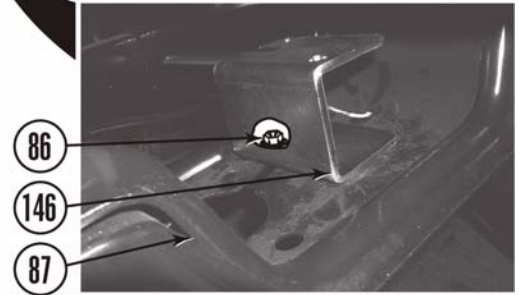

b. Position spare tire crank mechanism (85) through hole in crossmember (87). Position spare tire crank mechanism on *kit* spare tire carrier (146) and turn *kit* bracket toward front of vehicle to slide spare tire crank mechanism cable (147) through slot in *kit* spare tire carrier. Start passenger side bolt (86) and tighten both bolts.

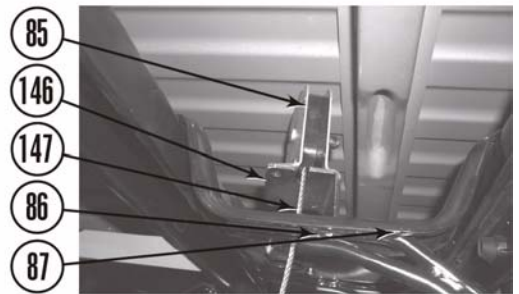

c. Install spare tire crank mechanism (85) on *kit* spare tire carrier (146) with two *kit* 1/4" x 1" bolts (123), four *kit* 1/4" SAE washers (124), and two *kit* 1/4" nylock nuts (125).

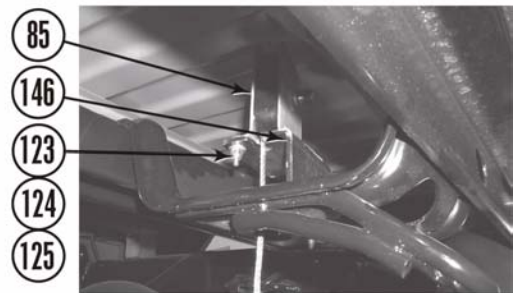

d. Install ratchet tube (84) on spare tire crank mechanism (85) with clip (83).

e. Raise spare tire (see owner's manual).

b. Remove clip (83) and ratchet tube (84) from spare tire crank mechanism (85) and store with rest of tire change kit.

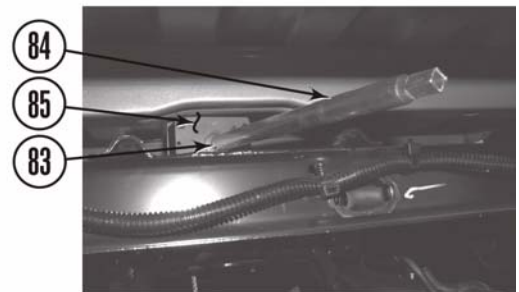

⚠WARNING

The following procedure is intended only to enhance the appearance of the vehicle. The rear bumper will no longer be rated for towing of any kind. Towing with the rear bumper after it has been lifted can result in death, serious personal injury, or damage to the vehicle. Towing after the bumper has been lifted should be accomplished using a rated Class III receiver type hitch.

14. Install the rear bumper.

a. Coat threads of bolts (74, 78, 80, 82, and 150) and nuts (75, 79, 81, and 121) with Loctite®.

b. Install two *kit* rear bumper brackets (148) on frame (15) with two double bolt fasteners (80), four nuts (79), two nut fasteners (75) and two bolts (74). Do not tighten.

c. Install *kit* middle bumper bracket (149) on trailer hitch (77) (or frame (15) if no hitch) with two bolts (78). Do not tighten.

d. Install rear bumper (65) on two *kit* rear bumper brackets (148) with two double bolt fasteners (82) and two nuts (81). Do not tighten.

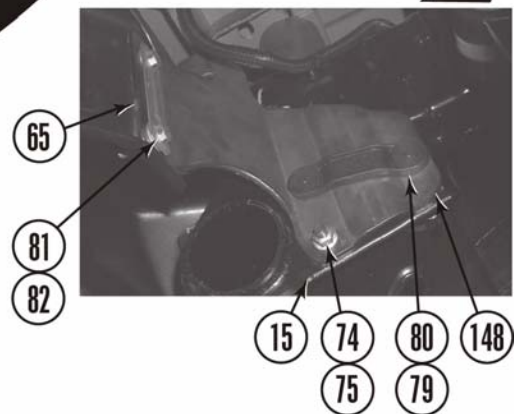
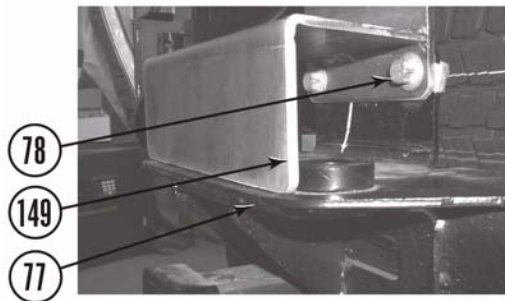
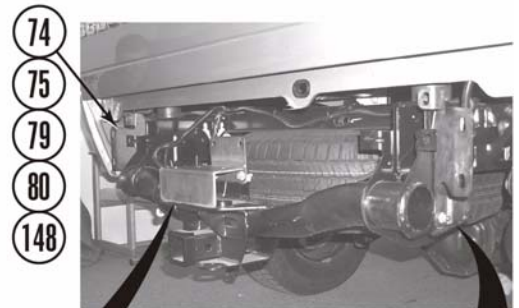

e. Install rear bumper (65) on *kit* middle bumper bracket (149) with two *kit* 7/16" x 1 1/2" bolts (150), four *kit* 7/16" USS washers (100), and two *kit* 7/16" nylock nuts (121). Do not tighten.

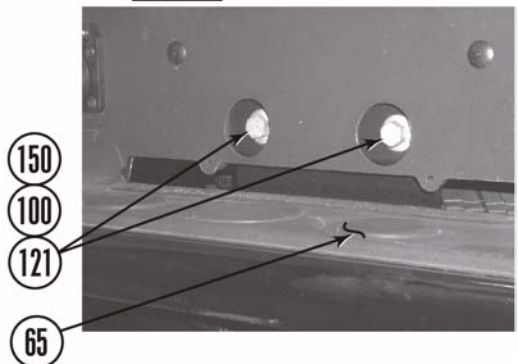
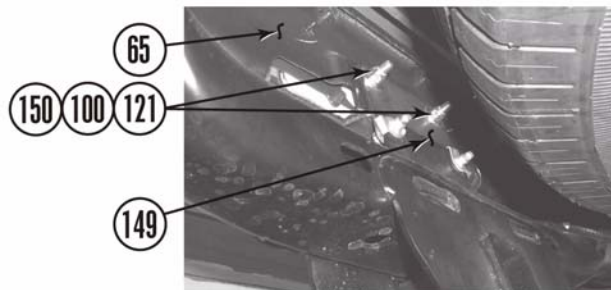

f. Install two *kit* 7/16" x 1 1/2" bolts (150), four *kit* 7/16" USS washers (100), and two *kit* 7/16" nylock nuts (121) through frame (15) and rear bumper (65). Do not tighten.

g. Adjust bumper to bed clearance and tighten bolts (74, 78, 80, 82, and 150) and nuts (75, 79, 81, and 121) to 55 lb-ft.

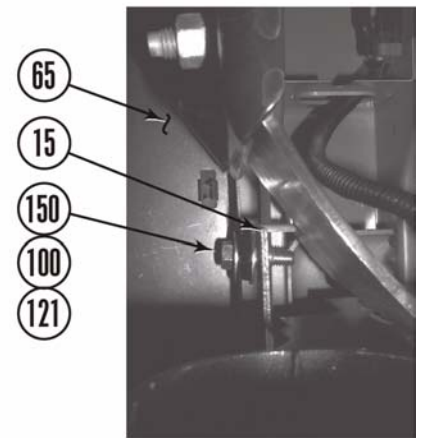

h. Pull harness (73) through rear bumper (65) and connect hitch connector (71). Install red thing (72) in hitch connector and clip hitch connector in rear bumper.

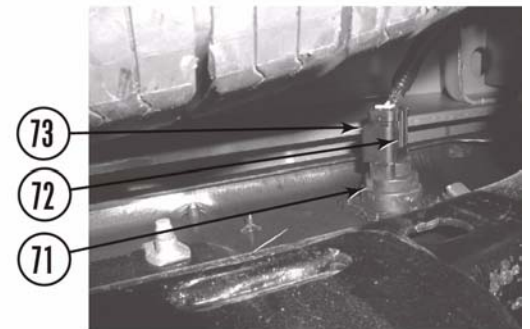

i. Install two connectors (67) on license plate lights (68).

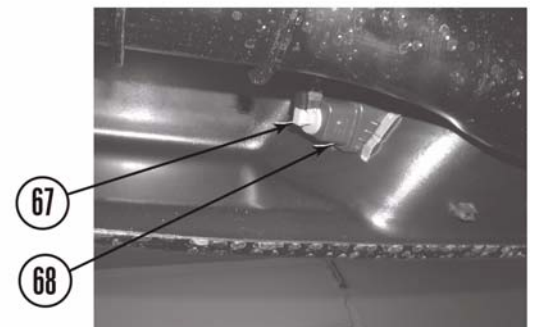

j. Install license plate (70) on rear bumper (65) with four screws (69).



15. Install bed crush blocks.

⚠WARNING

A certified welder should perform all welding.

a. Weld four *kit* crush blocks (151) on frame (15).



D. After installation is complete.

1. Install two airbag fuses #52 and #53 (6 and 7) in fuse panel (8). Install cover (5) and tighten thumb-wheel (4).

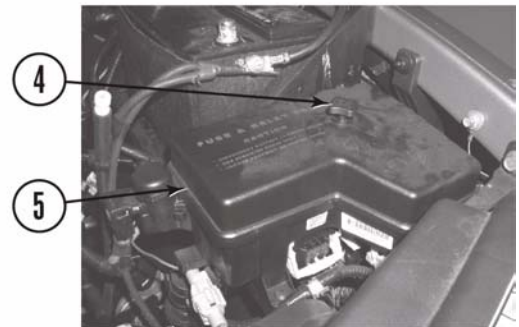

2. Connect both battery cables to the battery (3). Be sure to reconnect the positive cable (2) first, then the negative cable (1).

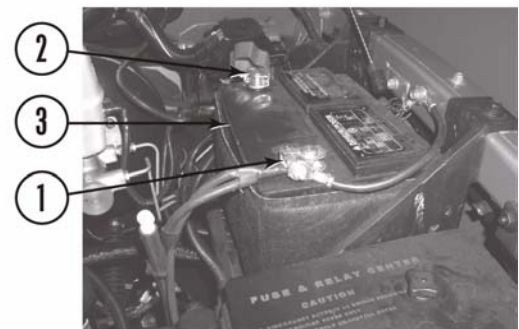

⚠NOTE

Step 3 is for vehicles with manual transfer case only. Other models skip this step.

3. Check transfer case shift lever operation. Ensure there is complete engagement in all ranges. If necessary, adjust linkage (152).

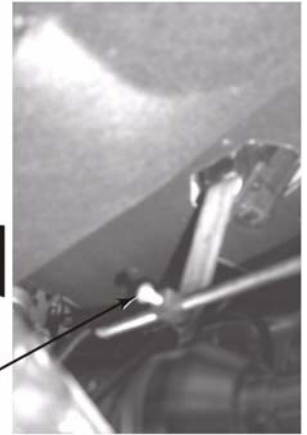

4. Stick *kit* warning sticker on the dash in plain sight of all vehicle occupants.
5. Double check the vehicle.

⚠CAUTION

Retorque all fasteners after 500 miles and after off road use. All body lift components should be visually inspected and fasteners retorqued during routine vehicle servicing.

- a. Check all mounting hardware to ensure it is properly tightened.
- b. Check all wires, hoses, cables, etc. to ensure they have been properly connected and there is ample slack. With the number of hoses on this vehicle, it is vital that this be checked thoroughly.
- c. Check vehicle electrical system.
- d. Start vehicle and check the steering in both directions to ensure that there is no bind. Check clutch operation. Check the operation of the brake system and the parking brake. Check both shift levers' operation. Ensure that there is proper engagement in all gears and 4 wheel drive ranges.

⚠CAUTION

Never open a closed cooling system after the vehicle has been started. Only fill the cooling system if the cap has been removed while the vehicle was still cold.

- e. Check coolant level. Fill coolant to the proper level (refer to the Owner's Manual).

f. Test drive vehicle in all gears and 4 wheel drive ranges. Pay close attention to all vehicle systems. Check all hardware again in 500 miles and as part of your regular maintenance schedule.

⚠CAUTION

Performance Accessories does not recommend any particular wheel and tire combinations for use with its body lifts and cannot assume responsibility for the customer's choice of wheels and tires. Reference your owner's manual for recommended tire sizes and warnings related to the use of oversized tires. Larger wheel and tire combinations increase stress and wear on steering and suspension components, which leads to increased maintenance and higher risk for component failure. Larger wheel and tire combinations also alter speedometer calibration, braking effectiveness, center of gravity, and handling characteristics. Consult with an experienced local off road shop to find what wheel and tire combinations work best with your vehicle.

⚠NOTE

All warranty information, instruction sheets, and other documents regarding the installation of this product must be retained by the vehicle owner. Information contained in the instructions and on the warranty card will be required for any warranty claims. The vehicle owner needs to understand the modifications made to his vehicle and how they affect vehicle handling and performance. Failure to provide the customer with this information can result in damage to the vehicle and severe personal injury.

Rev 3/02

E. Kit Parts List.

Quantity	Description
	Kit
16	3 x 3 blocks
4	Front bumper brackets
2	Left and right rear bumper brackets
1	Middle rear bumper bracket
1	Driver side fan shroud bracket
1	Passenger side fan shroud bracket
1	Spare tire mechanism bracket
1	Filler hose extension
4	3" crush blocks
1	Warning to driver sticker
1	Logo sticker
1	6ml bottle Loctite
1	Bolt pack BP60083
1	Parking brake bracket
8	12mm x 1.75 x 180mm bolts
2	12mm x 1.75 x 120mm bolts
8	12mm x 1.75 x 100mm bolts
16	7/16" USS washers
1	Steering extension
1	3/8" x 1 1/4" socket head bolt
1	4wd shift lever extension
1	Hardware pack HP600183
	Bolts
1	5/16" x 1" bolt
1	7/16" x 1" bolts
4	7/16" x 1 1/2" bolts
23	1/4" x 1" bolts
	Washers
18	7/16" USS washers
2	5/16" USS washers
48	1/4" SAE washers
	Nuts
2	12mm nylock nuts
5	7/16" nylock nuts
1	5/16" nylock nuts
25	1/4" nylock nuts
	Miscellaneous
1	Manual transmission shift lever extension
1	Vent hose extension
2	#10 hose clamps
2	#36 hose clamps
1	3" ground strap (big hole)
1	3" ground strap
2	2 3/4" front bumper bracket spacer tubes
2	1 1/2" transmission cooler bracket spacer tubes
2	2" S-shaped brackets w/studs
	Installation instructions

Front bumper bracket (assembled)



Rear bumper bracket



Hitch bracket



Fan shroud brackets



Parking brake bracket

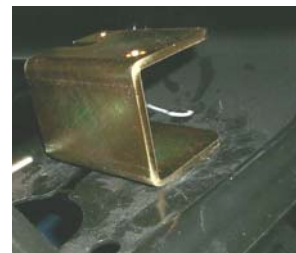

Spare tire bracket