



#D5 Installation Instructions 03-09 Dodge Ram 2500/3500 5" Suspension System

Read and understand all instructions and warnings prior to installation of product and operation of vehicle.

Zone Offroad Products recommends this system be installed by a professional technician. In addition to these instructions, professional knowledge of disassembly/ reassembly procedures and post installation checks must be known. Minimum tool requirements include the following: Assorted metric and standard wrenches, hammer, hydraulic floor jack and a set of jack stands. See the "Special Tools Required" section for additional tools needed to complete this installation properly and safely.

» PRODUCT SAFETY WARNING

Certain Zone Suspension Products are intended to improve off-road performance. Modifying your vehicle for off-road use may result in the vehicle handling differently than a factory equipped vehicle. Extreme care must be used to prevent loss of control or vehicle rollover. Failure to drive your modified vehicle safely may result in serious injury or death. Zone Offroad Products does not recommend the combined use of suspension lifts, body lifts, or other lifting devices.

You should never operate your modified vehicle under the influence of alcohol or drugs. Always drive your modified vehicle at reduced speeds to ensure your ability to control your vehicle under all driving conditions. Always wear your seat belt.

» TECHNICAL SUPPORT

Live Chat provides instant communication with Zone tech support. Anyone can access live chat through a link on www.zoneoffroad.com.

www.zoneoffroad.com may have additional information about this product including the latest instructions, videos, photos, etc.

Send an e-mail to tech@zoneoffroad.com detailing your issue for a quick response.

888.998.ZONE Call to speak directly with Zone tech support.

» PRE-INSTALLATION NOTES

1. Special literature required: OE Service Manual for model/year of vehicle. Refer to manual for proper disassembly/reassembly procedures of OE and related components.
2. Adhere to recommendations when replacement fasteners, retainers and keepers are called out in the OE manual.
3. Larger rim and tire combinations may increase leverage on suspension, steering, and related components. When selecting combinations larger than OE, consider the additional stress you could be inducing on the OE and related components.
4. Post suspension system vehicles may experience drive line vibrations. Angles may require tuning, slider on shaft may require replacement, shafts may need to be lengthened or trued, and U-joints may need to be replaced.
5. Secure and properly block vehicle prior to installation of Zone Offroad Products. Always wear safety glasses when using power tools.
6. If installation is to be performed without a hoist, Zone Offroad Products recommends rear alterations first.
7. Due to payload options and initial ride height variances, the amount of lift is a base figure. Final ride height dimensions may vary in accordance to original vehicle attitude. Always measure the attitude prior to beginning installation.

Difficulty Level

easy 1 2 **3** 4 5 difficult

Estimated installation: 4 hours

Special Tools Required

Pitman arm puller

Tire/Wheel Fitment

36 x 12.50 x 17 with 4-1/2" of backspacing

Kit Contents

Qty	Part
1	Pitman Arm 03-08
	or
1	<i>Pitman Arm 09+</i>
2	Bump Stop
2	Bump Stop Brackets
1	Bump Stop Bolt Pack
1	Track Bar Bracket 03-07
	or
1	<i>Trac Bar Bracket 08+</i>
1	Track Bar Bolt Pack
2	Sway Bar Link Extension
2	Lower Control Arm
2	Upper Control Arm
8	LCA Bushings - RED
8	UCA Bushings - RED
4	LCA Sleeve (long)
4	UCA Sleeve (short)
6	90° Grease Fitting
2	Straight Grease Fitting
1	Zone Shock Sticker
1	Large Sticker



INSTALLATION INSTRUCTIONS

» PRE-INSTALLATION NOTE

1. PowerWagon Models: As a result of the automatic disconnecting front sway bar unique to the PowerWagon, the front sway bar links vary from the standard design. This is the only component difference between the standard and PowerWagon suspension system. Follow the instructions as they are written. Refer to the instruction sheet supplied with the PowerWagon sway bar link kit #D5301 when you get to the removal and installation steps for the standard sway bar links.
2. PowerWagon Models: These models come from the factory with a 2" taller ride height compared to the standard models. When adding this suspension system, the net lift will be 3" over the factory PowerWagon suspension height, which will be equivalent to a standard model's height with the same lift.

» FRONT INSTALLATION

1. Park the vehicle on a clean, flat surface and block the rear wheels for safety.
2. Disconnect the front trackbar from the frame, retain hardware. **Figure 1**



Figure 1

3. Raise the front of the vehicle and support the frame with jack stands.
4. Remove the wheels.
5. Support the front axle with a hydraulic jack.
6. Open the hood and remove the upper shock stem nuts. **Figure 2**

Important—measure before starting!

Measure from the center of the wheel up to the bottom edge of the wheel opening

LF _____ RF _____

LR _____ RR _____



Figure 2

7. Disconnect the brake lines from the axle brackets.
8. Disconnect the sway bar links from the sway bar. Retain all hardware. Figure 3

Step 8 Note:

PowerWagon Models: Refer to the #D5301 sway bar link kit instructions.



Figure 3

9. Disconnect the shock from the lower mount. The head of the bolt is accessed through a hole in the front of the axle spring perch. Remove the shocks and retain the mounting hardware.
10. Remove the factory bump stops from the frame. Pull them free of the frame mount with channel lock pliers or hit them sideways with a hammer to dislodge.
11. Disconnect the drag link from the pitman arm. Use caution not to damage the boot. Retain hardware.
12. Remove the pitman arm nut from the sector shaft. Mark the position of the pitman arm, this position will be transferred over to the new pitman arm.

Figure 4 & 5.

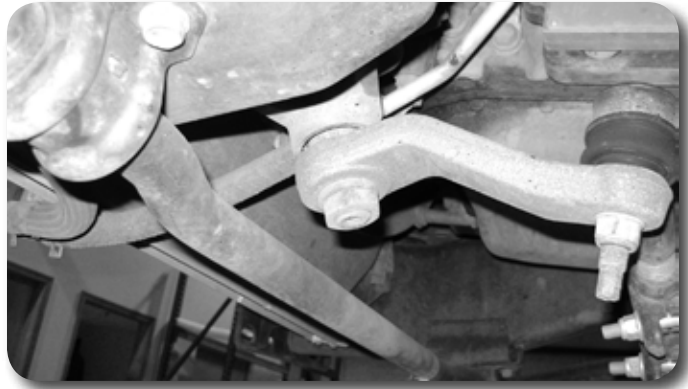

Figure 4

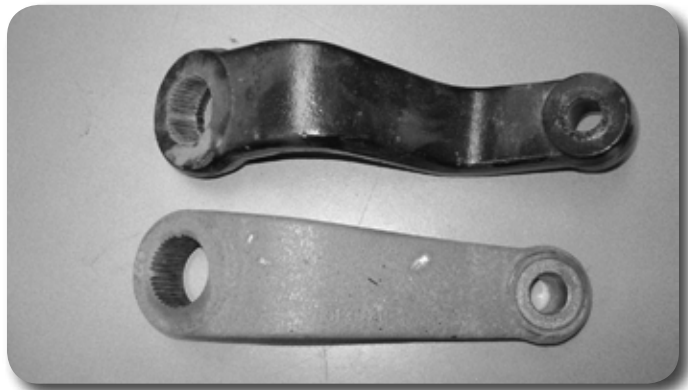

Figure 5

Step 15 Note

On older model vehicles the cams may become corroded into the control arms. If this is the case, a ball joint press tool may be used to press the bolts out. If this method is not successful, the cam bolts must be cut and replaced by new hardware available through Chrysler.

Step 17 Note

On some models the upper passenger's side control frame bolt will hit the exhaust. A new bolt is provided for this position so that the bolt head can be cut off and driven out the opposite direction. This will eliminate the need for removing the exhaust to allow removal of the upper control arm.

13. Transfer the index mark over to the new pitman arm. Install the new pitman arm on the shaft by lining up the splines on the pitman arm and sector shaft so that the indexing is correct. Fasten the pitman arm with the stock hardware and torque to ft-lbs.
14. On both sides of the vehicle, make index marks on the alignment eccentrics at the axle **Figure 6**. Mark the cams to indicate driver's versus passenger's side.

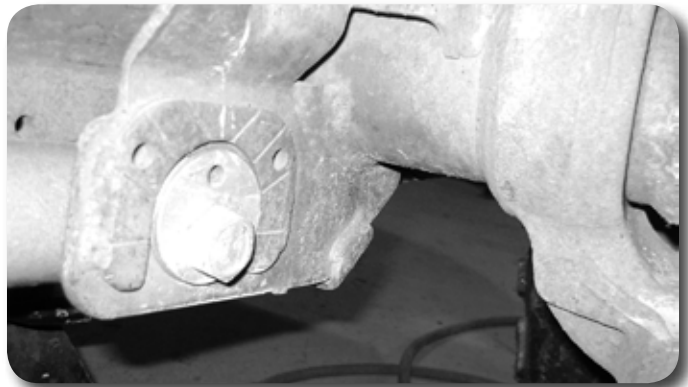

Figure 6

15. Working on one side of the vehicle at a time, remove the lower control arm cam bolt. Disconnect the lower control arms from the frame and remove them from the vehicle.
16. Retain hardware. Note: Ensure that the axle is well supported.
17. Disconnect the upper control arm from the frame and the axle. Retain hardware.

18. Lower the jack until the spring can be removed from the vehicle. Also, remove the upper spring isolator. The isolator will be reused. Figures 7 & 8

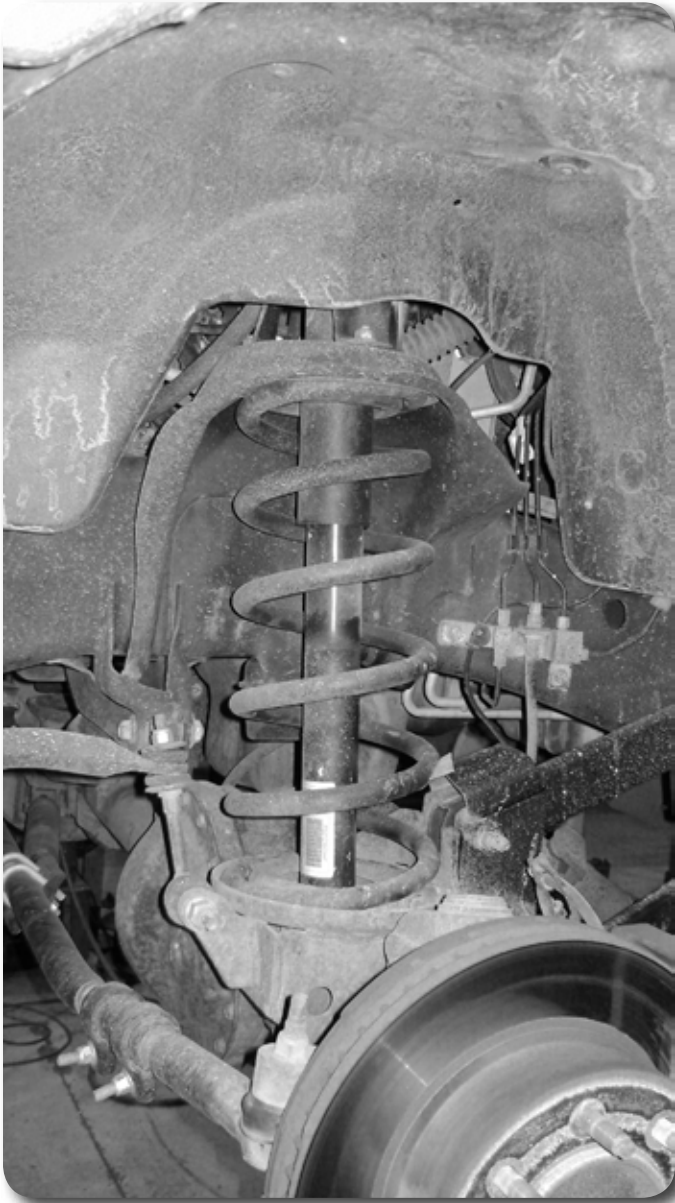

Figure 7



Figure 8

19. Lightly grease and install the provided bushings and sleeves in the new lower control arms (Longer sleeves that have a larger outside diameter). These are the larger sleeves that will accept the lower control arm hardware. Install grease fittings in the threaded holes at each end of the arms. The grease fittings should point in toward the control arm when installed. **Figure. 9** Note: The lower control arms are longer than the upper control arms.

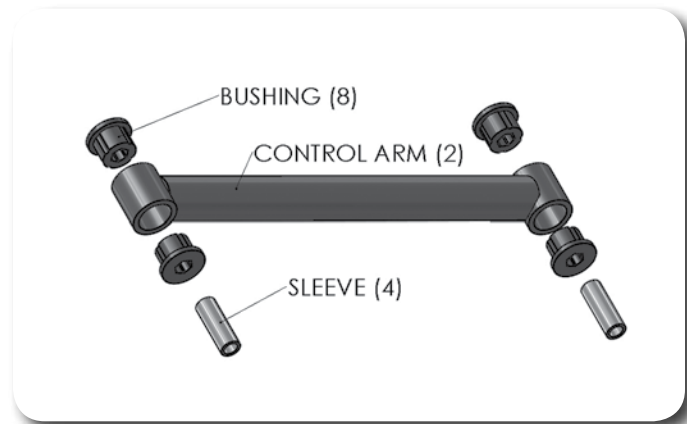

FIG. 9

20. Install the lower control arms in the frame and axle mount locations with the original hardware. Install the arms so that the grease fittings are up. Leave hardware loose.
21. Lightly grease and install the upper control arm bushings and sleeves. These are the shorter sleeves that accept 14mm hardware. Install a grease fitting in the frame end so that the fitting points toward the control arm. Install a straight grease fitting in the axle end of the arm so that it will point out toward the front of the vehicle.
22. Ensure that the brake line is running above the lower control arm and under the upper control arm. Install the new upper control arms with the original hardware (or new hardware (included) if required). Install the arms so that the frame end grease fitting is up. Install the hardware at the axle from the outside facing inside.
23. Repeat control arm and coil installation for opposite side.
24. Lightly grease and install the shock bushings and sleeves into the front shocks. Place the cup washer and stem bushing on the top stud.
25. Install the original spring isolators on top of the new coil springs. Place the shock inside the coil and install the coil springs in the vehicle.
26. Install lower shock hardware and torque to 75 ft-lbs. Slightly compress the coils and attach the upper shock stem hardware. Tighten until the bushings begin to swell.
27. Locate the 2 recesses inside the factory bump stop cup. Drill the center of the indentations to 5/16" ~ 21/64" and cut threads into the frame with 3/8" self threading bolts. Remove the bolts and attach the bump stop drop brackets with 3/8" hardware. Loc-tite the threads. **Figure 10a**
28. Install the new bump stops into the drop brackets with 3/8" nuts, washers, and lock washers. **Figure 10b**

Step 28 Note

Bump stop drop hardware is located in bolt pack #785.



Figure 10a

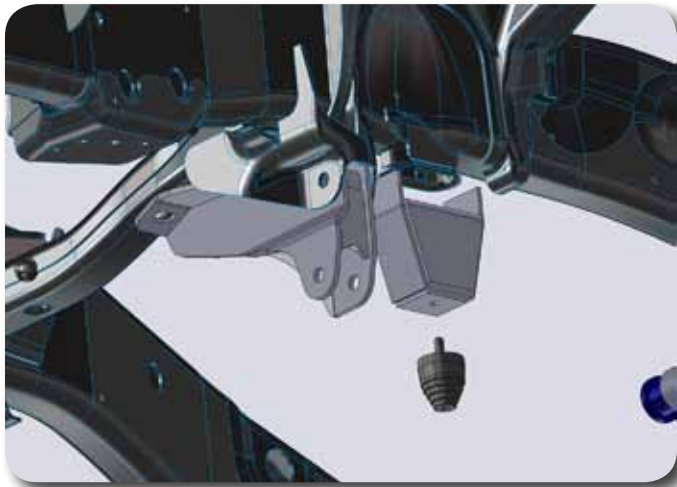

Figure 10b

29. Install the new track bar bracket to the factory frame mount with the 9/16 hardware (03-07), 5/8" hardware (08+). Attach the end of the bracket to the frame crossmember with the 9/16 hardware **Figure 10b** Torque the 9/16 hardware to 125 ft-lbs, 5/8" hardware to 150 ft-lbs (if applicable). Do not install the trackbar at this time.
30. Apply loctite to the threads on the factory sway bar links. Thread the provided link extension on the factory links and tighten securely. Attach the extension to the sway bar with the factory washers, bushings and nuts. Tighten the nut until the bushings begin to swell. **Figure. 11** Do not tighten the nut all the way down, it only needs to be tightened enough to make the bushing begin to deform.

Step 29 Note

03-07 Trackbar hardware is 9/16" x 3" is located in bolt pack # 609

08 + Trackbar hardware is 9/16" x 3 and 5/8" x 3" Located in bolt pack # 642 08+

Step 30 Note:

PowerWagon Models: Refer to the #D5301 sway bar link kit instructions.

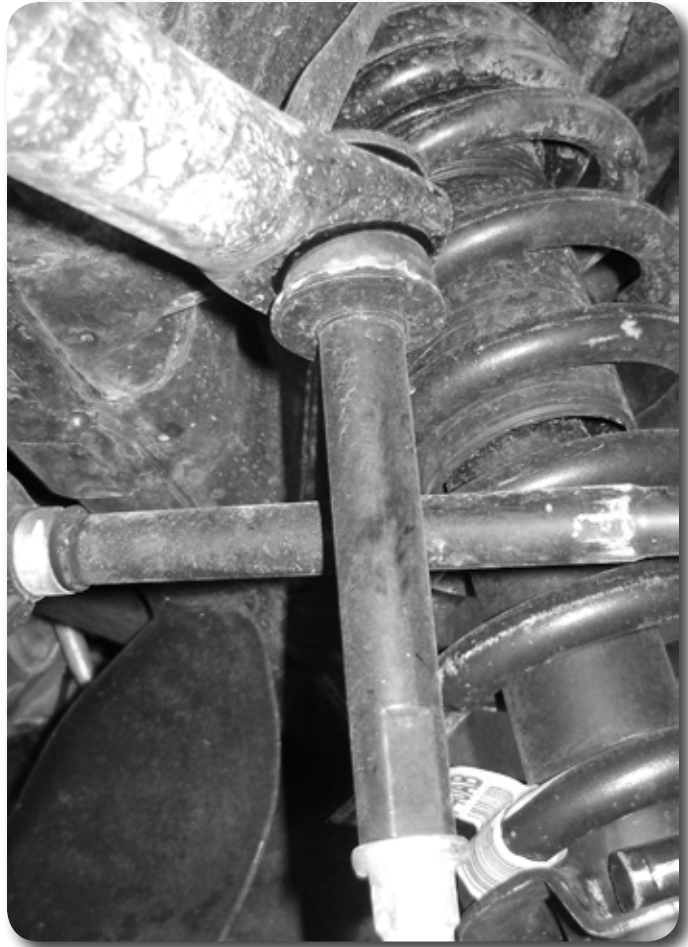

Figure 11

31. Attach the drag link to the new pitman arm with the factory nut. Torque to 55 ft-lbs.
32. Reattach the brakeline to the axle with the factory hardware. Tighten to 25 ft-lbs.
33. Reinstall the front wheels.
34. Lower the vehicle to the ground.
35. Connect the trackbar at the frame with the factory hardware. It may be necessary to have someone turn the steering wheel in order to get the holes to align. Tighten to factory specifications
36. Adjust the lower cam to the original position. Tighten the lower control arms hardware to 160 ft-lbs, upper to 110 ft-lbs.
37. Double check all components for proper torque.

» REAR INSTALLATION

38. Block the front wheels. Raise the rear of the vehicle and support the frame with jackstands. Remove the rear wheels.
39. Support the rear axle with a hydraulic jack.
40. Disconnect the rear shock hardware, keep hardware for reinstallation, discard the shocks.
41. Disconnect the parking brake cable at the junction block in front of the rear spring hanger. Disconnect both lines from the front half of the cable. **Figure 12**



Figure 12

42. Reform the rear brakeline bracket at the frame to point slightly down. This will allow the rear axle to droop more.
43. Working on one side, disconnect the u-bolts and lower the axle. Remove the plastic center pin and install the new metal one. It may be necessary to take a die grinder to slightly enlarge the opening in the lowest leaf. This should be a snug to press fit.
44. Install the new lift block between the axle and spring pack. Install new u-bolts. Snug the u-bolts at this time, but do not tighten.
45. Repeat block installation for the opposite side.
46. Check rear brakeline for slack. Reform the brakeline at the frame if necessary.
47. Lightly grease and install the bushings and sleeves into the new shocks. Install the shocks with the factory hardware.
48. Reattach the Emergency-brake cable.
49. Reinstall the wheels and lower the vehicle to the ground.
50. Torque the u-bolts to 110-125 ft-lbs.
51. Recheck all fasteners and lug nuts for proper torque, again after 500 miles, and at regularly scheduled maintenance intervals.

Post-Installation Warnings

1. Check all fasteners for proper torque. Check to ensure for adequate clearance between all rotating, mobile, fixed, and heated members. Verify clearance between exhaust and brake lines, fuel lines, fuel tank, floor boards and wiring harness. Check steering gear for clearance. Test and inspect brake system.
2. Perform steering sweep to ensure front brake hoses have adequate slack and do not contact any rotating, mobile or heated members. Inspect rear brake hoses at full extension for adequate slack. Failure to perform hose check/ replacement may result in component failure.
3. Perform head light check and adjustment.
4. Re-torque all fasteners after 500 miles. Always inspect fasteners and components during routine servicing.