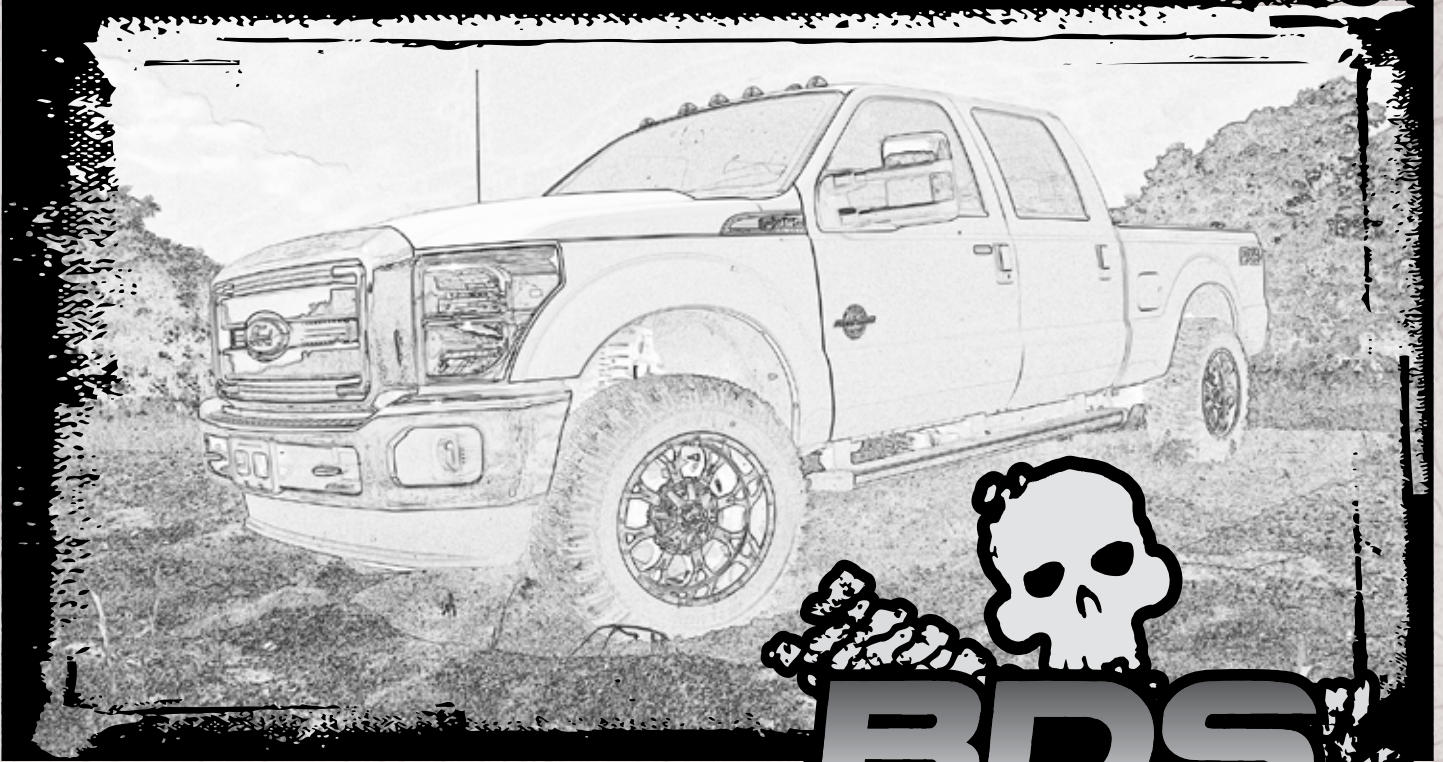


# INSTALLATION GUIDE



Part#: 013255

**HARDCORE LIMITED LIFETIME WARRANTY**

**Ford F-250 / 350 2-1/2" Coil Kit**

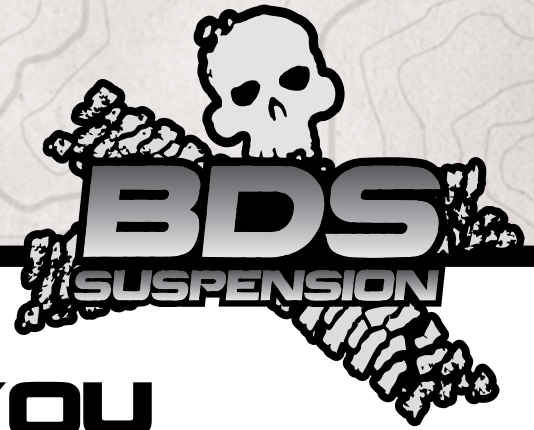
**Ford F-250, F350 | 2011-2015**

Rev.040815

491 W. Garfield Ave., Coldwater, MI 49036 • Phone: 517-279-2135

Web/live chat: [www.bds-suspension.com](http://www.bds-suspension.com) • E-mail: [tech@bds-suspension.com](mailto:tech@bds-suspension.com)

# Read And Understand All Instructions And Warnings Prior To Installation Of System And Operation Of Vehicle.



## THANK YOU

Your truck is about to be fitted with the best suspension system on the market today. That means you will be driving the baddest looking truck in the neighborhood, and you'll have the warranty to ensure that it stays that way for years to come. Thank you for choosing BDS Suspension!

### BEFORE YOU START

BDS Suspension Co. recommends this system be installed by a professional technician. In addition to these instructions, professional knowledge of disassembly/ reassembly procedures and post installation checks must be known.

### FOR YOUR SAFETY

Certain BDS Suspension products are intended to improve off-road performance. Modifying your vehicle for off-road use may result in the vehicle handling differently than a factory equipped vehicle. Extreme care must be used to prevent loss of control or vehicle rollover. Failure to drive your modified vehicle safely may result in serious injury or death. BDS Suspension Co. does not recommend the combined use of suspension lifts, body lifts, or other lifting devices. You should never operate your modified vehicle under the influence of alcohol or drugs. Always drive your modified vehicle at reduced speeds to ensure your ability to control your vehicle under all driving conditions. Always wear your seat belt.

### BEFORE INSTALLATION

- Special literature required: OE Service Manual for model/year of vehicle. Refer to manual for proper disassembly/reassembly procedures of OE and related components.
- Adhere to recommendations when replacement fasteners, retainers and keepers are called out in the OE manual.
- Larger rim and tire combinations may increase leverage on suspension, steering, and related components. When selecting combinations larger than OE, consider the additional stress you could be inducing on the OE and related components.
- Post suspension system vehicles may experience drive line vibrations. Angles may require tuning, slider on shaft may require replacement, shafts may need to be lengthened or trued, and U-joints may need to be replaced.
- Secure and properly block vehicle prior to installation of BDS Suspension components. Always wear safety glasses when using power tools.
- If installation is to be performed without a hoist, BDS Suspension Co. recommends rear alterations first.
- Due to payload options and initial ride height variances, the amount of lift is a base figure. Final ride height dimensions may vary in accordance to original vehicle attitude. Always measure the attitude prior to beginning installation.



Visit [560plus.com](http://560plus.com) for more information.

### TIRES AND WHEELS

35x12.50x17(18)(20) Tire  
4-1/2" ~ 5" Backspace Wheel



### BEFORE YOU DRIVE

Check all fasteners for proper torque. Check to ensure for adequate clearance between all rotating, mobile, fixed, and heated members. Verify clearance between exhaust and brake lines, fuel lines, fuel tank, floor boards and wiring harness. Check steering gear for clearance. Test and inspect brake system.

Perform steering sweep to ensure front brake hoses have adequate slack and do not contact any rotating, mobile or heated members. Inspect rear brake hoses at full extension for adequate slack. Failure to perform hose check/ replacement may result in component failure. Longer replacement hoses, if needed can be purchased from a local parts supplier.

Perform head light check and adjustment.

Re-torque all fasteners after 500 miles. Always inspect fasteners and components during routine servicing.

# CONTENTS OF YOUR KIT

## 033251 - 2.5" Coil Springs

Part #	Qty	Description
033251R	2	Coil Spring

## 123251 - Radius Arm Box Kit - DRV

Part #	Qty	Description
A241	1	Radius Arm Assembly - DRV Side
02799	1	Superduty Radius Arm 2"-4"
868190	1	Superduty Bushing
97525A430	2	Rivets
02802	1	Name plate - aluminum
B1114	1	Bag Kit
02421	2	Cam plate
N18MPT	1	M18-2.5 Lock Nut
02002ZP	1	M18-2.5 x 150 Bolt
W34SAE	2	3/4" SAE flat washer
099000	3	Zip Ties

## 123252 - Radius Arm Box Kit - PASS

Part #	Qty	Description
A242	1	Radius Arm Assembly - PASS Side
02799	1	Superduty Radius Arm 2"-4"
868190	1	Superduty Bushing
97525A430	2	Rivets
02802	1	Name plate - aluminum
B1114	1	Bag Kit
02421	2	Cam plate
N18MPT	1	M18-2.5 Lock Nut
02002ZP	1	M18-2.5 x 150 Bolt
W34SAE	2	3/4" SAE flat washer
099000	3	Zip Ties

## 123202- Front Adjustable Track Bar Kit

Part #	Qty	Description
A230	1	Adjustable Trackbar Assembly
B1068	1	Bag Kit - Adjustable Track Bar

## 069408 - Rear 4" Block Kit

Part #	Qty	Description
02786	2	4" Superduty Rear Block
UBT4031	4	5/8" x 3-1/8" x 14" Semi Round U-bolts

## 013519 - 5" Rear Block Kit (Optional)

Part #	Qty	Description
02414	2	5" Rear Superduty Block
02415	2	Superduty Rear Spring Plate
343581500RB	4	3/4" x 3-5/8" x 15" Round U-bolt
B236	1	Bag Kit
N34FLG	8	3/4" Serrated Edge Flanged Nut

## TROUBLESHOOTING INFORMATION FOR YOUR VEHICLE

1. Trackbar mounting bolt requires 405 ft-lbs of torque, plan ahead on how to achieve this.

**TECH  
TIPS**

# INSTALLATION INSTRUCTIONS

## INSTALLATION INSTRUCTIONS

1. Park the vehicle on a clean, flat surface and block the rear wheels for safety.
2. Raise the front of the vehicle and support under the frame rails with jack stands.



**Tip**

*As a result of the location of the long radius arm suspension, support locations are limited. Use your best judgment while supporting the vehicle with sufficient strength stands at appropriate locations. The radius arms will need to move freely during this installation as they will be replaced. This step is necessary to dislodge the tapered track bar mount in the follow step.*

3. Remove the track bar ball joint nut at the axle. (Fig 1) Thread the nut back on a couple of turns. Raise the axle a couple of inches with the jack. Place an appropriate sized pry bar between the axle mount and the track bar. (Fig 2) Lower the axle to pinch the pry bar between the track bar and axle mount. Take your hands off of the pry bar. Continue lowering the axle until the track bar unseats from the taper. Remove the nut and track bar from the ball joint. Save nut.

**FIGURE 1**

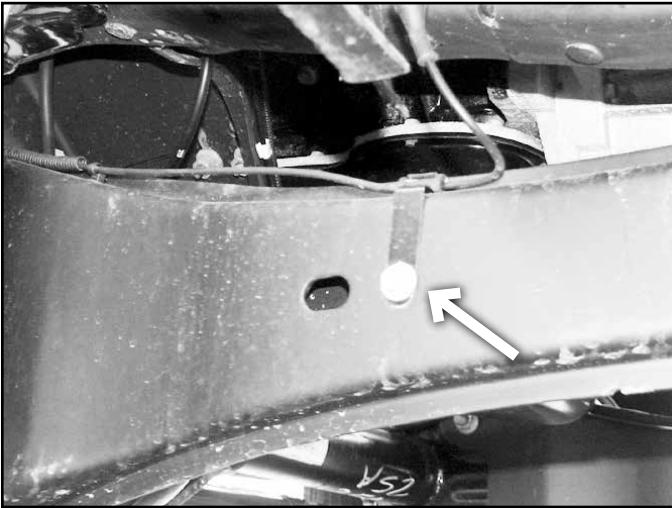


**FIGURE 2**

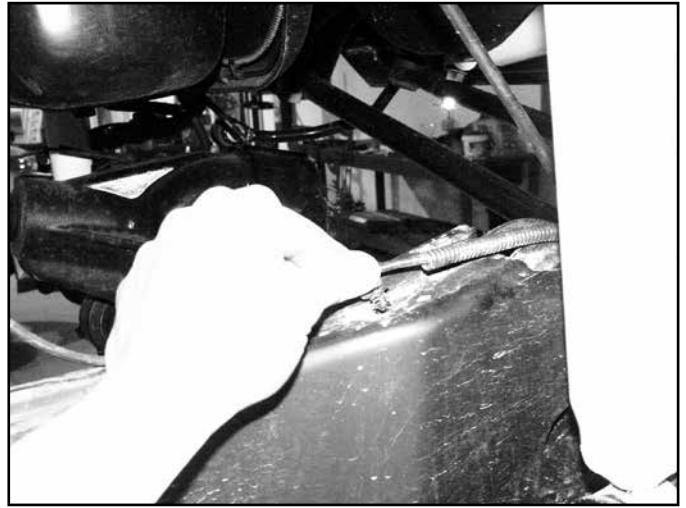


4. Disconnect the front track bar from the frame mount.
5. Remove the stock track bar. Retain all hardware.
6. Remove the front wheels.
7. Support the front axle with a hydraulic jack. With the axle supported this installation can be performed on both sides at the same time, but is not necessary.
8. Disconnect the sway bar links from the axle mounts. Retain hardware.
9. Remove the OE shock. Retain lower mounting hardware.
10. Remove the ABS line from the metal retaining tab on the radius arm (Fig 3). Pull the plastic retaining clip free from the radius arm (Fig 4).

**FIGURE 3**

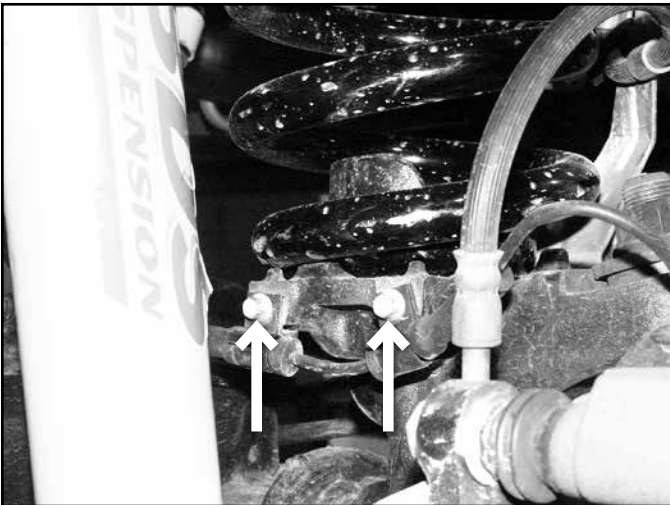


**FIGURE 4**

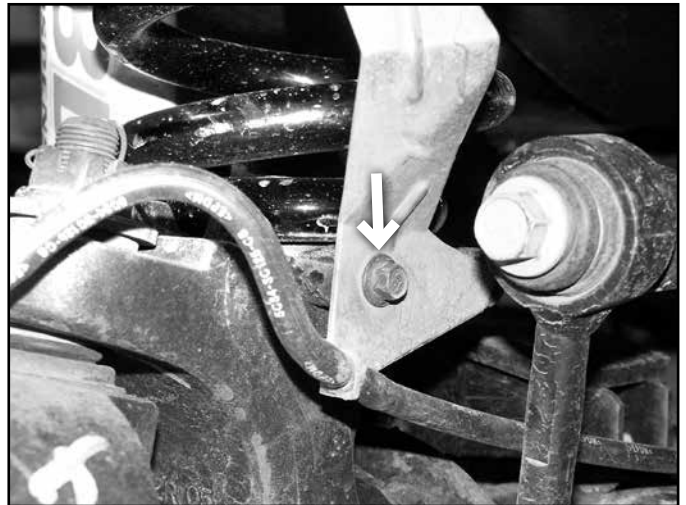


11. Remove the two bolts mounting the plastic ABS wire clips to the back side of the coil perch (Fig 5). Retain hardware.

**FIGURE 5**



**FIGURE 6**



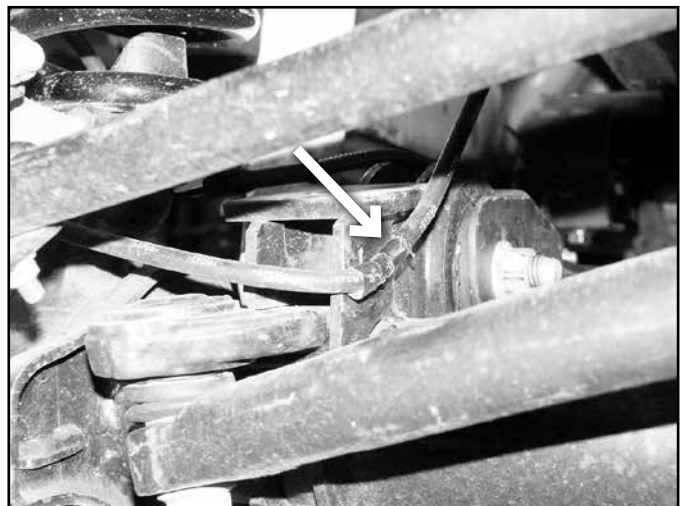
12. Disconnect the brake line bracket from the front of the coil perch (Fig 6). Retain hardware.

13. Free the hub vacuum line from the axle (Fig 7, 8).

**FIGURE 7**



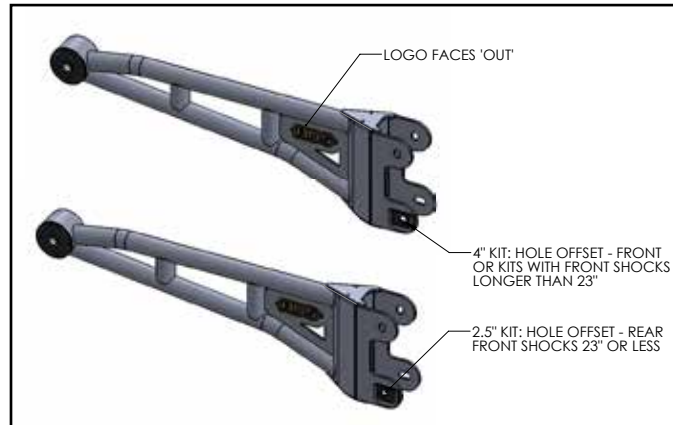
**FIGURE 8**



## RADIUS ARM INSTALLATION:

14. Working on one side of the vehicle at a time, remove the stock radius arm and replace with the new one. Install cams into the lower slots with new 18m hardware, and use new 18mm nut on the driver's side upper mount at the axle. (Fig 9)

**FIGURE 9**



## COIL INSTALLATION

15. Lower the axle until the spring is free and remove the spring from the vehicle. Note: Do not over extend the brake lines.
16. Install new coils with the factory rubber isolators located on top of the coils.
17. Compress the coils slightly by using a hydraulic jack on the axle. Install new shocks with factory lower hardware and stem washers, bushings, and 1/2" fine thread nut on the upper mount. Tighten the upper mount until the bushings begin to swell. Tighten lower mount to 50 ft-lbs.
18. Reattach all brake and vacuum lines to the original locations with the OE mounting hardware. There are provided zip ties for attaching the ABS wire to the radius arm. The rubber grommets on the ABS wire can be slid by spraying the ABS wire with silicone spray.
19. Reattach the sway bar links to the axle with the OE hardware and tighten securely.
20. Install the wheels and lower the vehicle to the ground. Ensure that the lower cam is orientated correctly in the slot. Tighten radius arm hardware to 150 ft-lbs.

## TRACKBAR INSTALLATION

21. Grease and install bushings and sleeves into track bar. Thread grease zerk into track bar. Remove (4) allen bolts and apply loc-tite to threads.
22. Adjust the track bar length (eye to eye) to 37-1/8" for 2-1/2" lift, 37-1/2" for 4" lift.
23. Install track bar into vehicle with the grease fitting facing down at the frame mount with factory bolt.
24. Attach the axle mount to the track bar. It may be necessary to have an assistant turn the wheel to get the mount to line up. Square the mount up to the factory joint. Attach with factory nut. Tighten to 184 ft-lbs
25. Ensure the axle is square under the vehicle. Additional adjustment of the track bar collar may be required. Do not extend past 37-5/8" eye-eye measurement, due to the maximum length of the factory drag link.
26. Tighten pinch bolt collar. Tighten to 40 ft-lbs, check the turnbuckle to ensure that it will not rotate, additional tightening may be required.
27. Tighten track bar hardware at the frame to 405 ft-lbs. Grease the track bar mount at the frame.
28. Install new brake line drop brackets onto the side of the frame with factory hardware and clip. (Fig 10a, 10b)

**FIGURE 10A**



**FIGURE 10B**



29. Check all hardware for proper torque.
30. Adjust steering wheel to center.
31. Check hardware after 500 miles.

## **REAR INSTALLATION 4" BLOCK KIT (5" BLOCK - SEE 013518-013519 INSTRUCTION SHEET)**

*Rear Installation Note: The factory rear block will vary depending on the vehicle model. F-250s will have a 1-7/8" block and F-350s will have a 3-3/4" block. In both cases, replacing the factory block with the new provided block will net the same level stance regardless of vehicle model.*

32. Block the front wheels for safety.
33. Raise the rear of the vehicle and support with jack stands under the frame rails just ahead of the spring hangers.
34. Remove the wheels.
35. Support the axle with a hydraulic jack.
36. Remove the factory shocks. Retain all mounting hardware.
37. Disconnect the passenger's side spring u-bolts. (Fig 11)

**FIGURE 11**



38. Remove the factory lift block. It will not be reused.

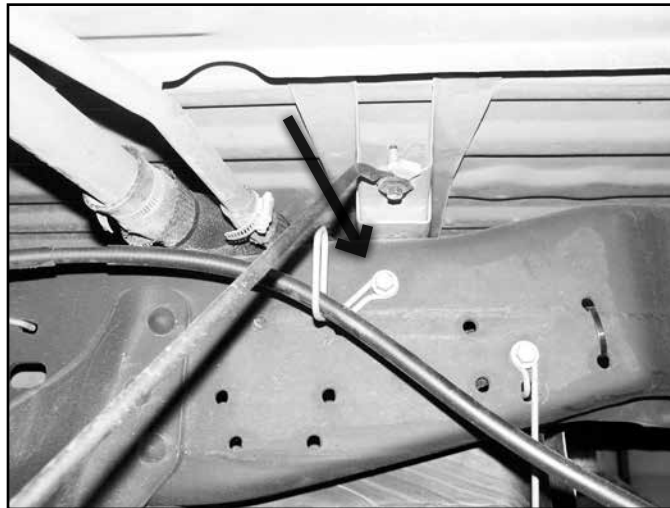
39. Lower the axle enough to place the provided 4" lift block between the axle and the leaf spring. Position the block so the bump stop wing faces inward.
40. Raise the axle to engage the block spring alignment pin. (Fig 12) Fasten the entire assembly with the provided u-bolts, high nuts and washers. Snug but do not torque the u-bolts at this time.

**FIGURE 12**



41. Repeat block installation of the driver's side. Take care not to over extend the brake lines.
42. If more parking brake cable slack is needed, remove the cable from the rear-most retaining bracket on the frame. (Fig 12)

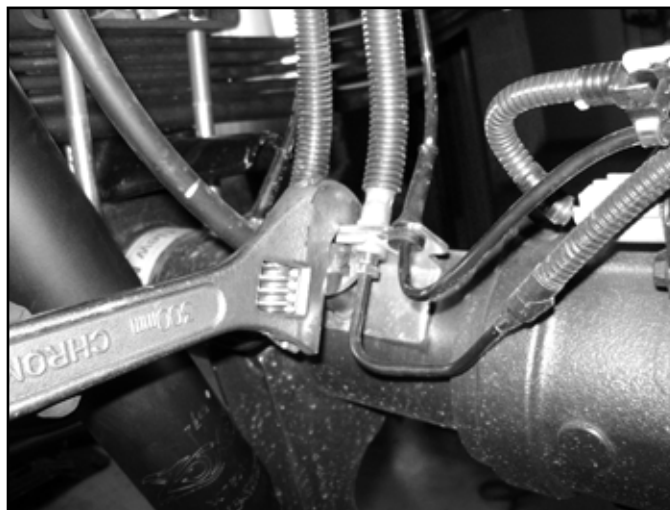
**FIGURE 13**



43. The brakelines may require additional slack. Located the factory bracket on the axle. Using an adjustable wrench, carefully bend the bracket so the fittings are positioned vertical to allow more slack. (Fig 14)



**FIGURE 14**



44. Install the new shocks with the original mounting hardware. Tighten to 55 ft-lbs.
45. Install wheels and lower the vehicle to the ground.
46. With the weight of the vehicle on the axle, torque the u-bolts to 130-150 ft-lbs.
47. Torque lug nuts to factory specification.
48. Recheck all hardware for proper torque, check again after 500 miles and at regularly scheduled maintenance intervals.



### **WE WANT TO SEE YOUR RIDE!**

Grab photos of your BDS-equipped truck in action and send them in for a chance to be featured. Send it in to our Bad Ass Rides customer gallery at [bds-suspension.com/bar](http://bds-suspension.com/bar) and post them on the BDS Fan Page on Facebook at [facebook.com/BDSSuspensions](https://facebook.com/BDSSuspensions). Don't forget about your BDS swag! BDS offers t-shirts, hoodies, decals and more available on the BDS website or through your local BDS distributor.

---

## **TIME TO HAVE SOME FUN**

**Thank you for choosing BDS Suspension.**

For questions, technical support and warranty issues relating to this BDS Suspension product, please contact your distributor/installer before contacting BDS Suspension directly.