



INSTALLATION INSTRUCTIONS

K2371		6" BASIC SYSTEM W/PERFORMANCE SHOCKS
1	FTS22324	COMPONENT BOX 1
1	FTS22326	COMPONENT BOX 2
2	FTS7266	PERFORMANCE SHOCK

K2372DL		6" PERF SYSTEM W/2.5 DL C/O & DLSS SHOCKS
1	FTS22325	COMPONENT BOX 1
1	FTS22326	COMPONENT BOX 2
1	FTS22332	2.5" DIRT LOGIC COILOVERS N/R
2	FTS81160	2.25" DIRT LOGIC SHOCKS N/R

K2371M		6" BASIC SYSTEM W/STEALTH SHOCKS
1	FTS22324	COMPONENT BOX 1
1	FTS22326	COMPONENT BOX 2
2	FTS6266	PERFORMANCE SHOCK

K2373DL		6" PERF SYSTEM W/2.5 RESI C/O & DL SHOCKS
1	FTS22325	COMPONENT BOX 1
1	FTS22326	COMPONENT BOX 2
1	FTS22333	2.5" DIRT LOGIC COILOVERS W/RESI
2	FTS81160	2.25" DIRT LOGIC SHOCKS N/R

2021 FORD F-150 4WD

6" BASIC & PERFORMANCE SYSTEMS

FT22324i

NOTE: TO ORDER WEARABLE REPLACEMENT COMPONENTS DO NOT USE PART NUMBERS SHOWN ON THIS INSTRUCTION SHEET. GO TO FABTECH WEBSITE AND LOOK UP WEARABLE REPLACEMENT PARTS TO FIND THE PROPER PART NUMBER TO ORDER.

Fabtech Motorsports | 4331 Eucalyptus Ave. Chino, CA 91710

Tech Line: 909-597-7800 | **Fax:** 909-597-7185 | **Web:** www.fabtechmotorsports.com

FTS22324 COMPONENT BOX 1 (BASIC)		
1	FT30377BK	SKID PLATE
2	FT30378	DIFF DROP BRACKET
1	FT30954	HARDWARE KIT
1	FT30645	CENTER DIFF BRACKET
1	FT30942D	SPINDLE (DRIVER)
1	FT30942P	SPINDLE (PASSENGER)
1	FT30943	HARDWARE SUBASSEMBLY
1	FT30944	LOWER SHOCK EXTENSION (DRIVER)
1	FT30949	LOWER SHOCK EXTENSION (PASSENGER)
1	FT30985	HARDWARE KIT
4	FT20568BK	SHOCK BRACKET

FTS22325 COMPONENT BOX 1 (PERFORMANCE)		
1	FT30377BK	SKID PLATE
2	FT30378	DIFF DROP BRACKET
1	FT30954	HARDWARE KIT
1	FT30645	CENTER DIFF BRACKET
1	FT30942D	SPINDLE (DRIVER)
1	FT30942P	SPINDLE (PASSENGER)
1	FT30945	HARDWARE SUBASSEMBLY

FT30943 HARDWARE SUBASSEMBLY		
2	FT1020	BUSHING
1	FT181	SLEEVE
2	FT30496	BRAKE LINE BRACKET (FRONT)
1	FT22324i	INSTRUCTIONS
2	FT292	ALIGNMENT CAM KIT
1	FT30608	DRIVESHAFT SPACER
1	FT30610	VACUUM HOSE 7"
1	FT30646BK	REAR CROSSMEMBER DIFF PLATE
4	FT30946	ALUMINUM HALF BUSHING
1	FT70033	BRAKE LINE BRACKET (REAR)
1	FTAS12	STICKER FT BLUE 10X4
1	FTAS16	DRIVER WARNING DECAL
1	FTREGCARD	REGISTRATION CARD

FT30945 HARDWARE SUBASSEMBLY		
2	FT1020	BUSHING
1	FT181	SLEEVE
2	FT30496	BRAKE LINE BRACKET (FRONT)
1	FT22324i	INSTRUCTIONS
2	FT292	ALIGNMENT CAM KIT
1	FT30608	DRIVESHAFT SPACER
1	FT30610	VACUUM HOSE 7"
1	FT30646BK	REAR CROSSMEMBER DIFF PLATE
1	FT70033	BRAKE LINE BRACKET (REAR)
1	FTAS12	STICKER FT BLUE 10X4
1	FTAS16	DRIVER WARNING DECAL
1	FTREGCARD	REGISTRATION CARD

FTS22326 COMPONENT BOX 2		
1	FT30590	SWAY BAR DROP BRACKET (PASSENGER)
1	FT30591	SWAY BAR DROP BRACKET (DRIVER)
1	FT30644BK	CROSSMEMBER (FRONT)
1	FT30673BK	CROSSMEMBER (REAR)
4	FT744U	UBOLT
2	FTBK52	5" REAR BLOCK W/BUMPSTOP

FT30954 - HARDWARE KIT		LOCATION
1	1/2-13 X 3-1/2" HEX BOLT	PASS DIFF MOUNT
2	1/2-13 X 3-3/4" HEX BOLT	DRIVER/FRONT DIFF
1	1/2-13 X 4" HEX BOLT	REAR DIFF MOUNT
1	M18-2.5 X 150MM HEX BOLT	REAR DIFF MOUNT
2	M18 WASHER	
1	M18-2.5 C-LOCK NUT	
2	3/8-16 X 1" HEX BOLT	REAR DIFF MOUNT
4	3/8" SAE WASHER	
2	3/8-16 C-LOCK NUT	
3	M10-1.5 X 45MM HEX BOLT	FRONT DIFF MOUNT
3	M10 SPLIT LOCK WASHER	
3	M10 FLAT WASHER	
1	1/2-13 X 2" HEX BOLT	FRONT DIFF
3	1/2-13 X 1-1/4" HEX BOLT	SKID PLATE
3	5/16-18 X 1" HEX BOLT	BRAKELINE
6	5/16" SAE WASHER	
3	5/16-18 NYLOCK NUT	
4	1/2-13 X 3" HEX BOLT	LOWER STRUT/ ARM
4	7/16-14 X 1-1/4" HEX BOLT	SWAY BAR
8	7/16" SAE WASHER	
4	7/16-14 C-LOCK NUT	
24	1/2" SAE WASHER	
12	1/2-13 C-LOCK NUT	
8	5/8" SAE WASHER	UBOLTS
8	5/8-18 NYLOCK NUT	UBOLTS
8	7.5" CABLE TIE	
1	THREAD LOCKING COMPOUND	

FT30985 - HARDWARE KIT		LOCATION
8	5/16-18 X 1" HEX BOLT	STRUT BRACKET
16	5/16" SAE WASHER	
8	5/16-18 NYLOCK NUT	
4	1/2-13 X 4" HEX BOLT	STRUT BRACKET
8	1/2" SAE WASHER	
4	1/2-13 C-LOCK NUT	

- TOOL LIST -

Required Tools (Not Included)

- Basic Hand Tools
- Floor Jack
- Jack Stands
- Assorted Metric and S.A.E sockets, and Allen wrenches
- Torque Wrench
- Die Grinder w/ Cutoff Wheel or Sawzall

- PRE-INSTALLATION NOTES -

For technical assistance call: **909-597-7800** or e-mail: **info@fabtechmotorsports.com**

READ THIS BEFORE YOU BEGIN INSTALLATION -

Check all parts to the parts list above before beginning installation. If any parts are missing contact Fabtech at 909-597-7800 and a replacement part will be sent to you immediately.

This suspension and shocks have been designed to be installed on a stock vehicle.

Read all instructions thoroughly from start to finish before beginning the installation. If these instructions are not properly followed severe frame, driveline and / or suspension damage may occur.

Check your local city and state laws prior to the installation of this system for legality. Do not install if not legal in your area.

Prior to the installation of this suspension system perform a front end alignment and record. Do not install this system if the vehicle alignment is not within factory specifications. Check for frame and suspension damage prior to installation.

The installation of this suspension system should be performed by two professional mechanics. This suspension must be installed with Fabtech shock absorbers.

Installation of all fasteners requires the use of provided thread locking compound with proper torque values as indicated throughout the installation. Apply thread locking compound upon the final torque of the fastener.

WARNING- Installation of this system will alter the center of gravity of the vehicle and may increase roll over as compared to stock. Extreme care should be taken to operate the vehicle safely at all times to prevent rollover or loss of control resulting in serious injury or death.

Vehicles that receive oversized tires should check ball joints, uniballs, tie rods ends, pitman arm and idler arm every 2500-5000 miles for wear and replace as needed.

Verify differential fluid is at manufactures recommended level prior to kit installation. Installation of the kit will reposition the differential and the fill plug hole may be in a different position. (For example, if the manufacture recommends 3 quarts of fluid, make sure the diff has 3 quarts of fluid). Check your specific manual for correct amount of fluid.

Read all warnings and warranties on the last page of these instructions before starting installation.

FOOTNOTES -

- Can not use OEM wheel and tire.
- Fits SuperCrew only
- Will not fit Raptor models
- Fits gas models only
- Does not fit models equipped with CCD (Continuously Controlled Damping) system
- Does not fit hybrid models

- INSTRUCTIONS -

FRONT SUSPENSION

1. Disconnect the negative terminal on the battery. Jack up the front end of the truck and support the frame rails with jack stands. **NEVER WORK UNDER AN UNSUPPORTED VEHICLE!** Remove the front tires.
2. Remove and discard the factory skid plate/plastic guard under the differential.
3. Starting on the drivers side, disconnect the tie rod end from the steering knuckle by striking the knuckle to dislodge the tie rod end. Save hardware. **SEE FIGURE 1**

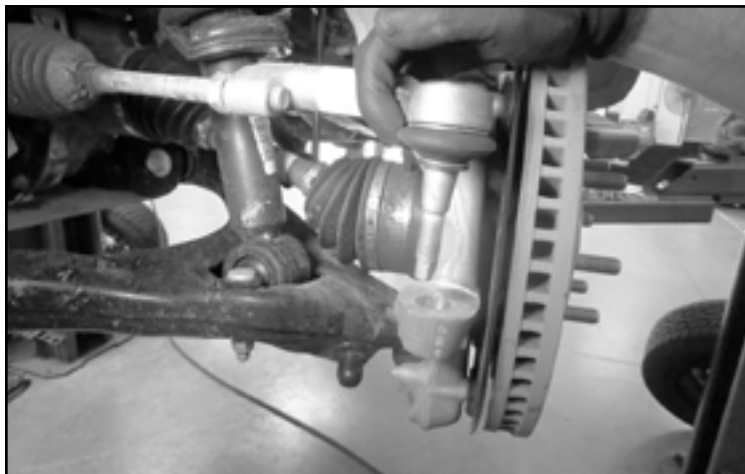

FIGURE 1 - STEP 3

4. Disconnect the factory sway bar link from the knuckle. Save hardware. **SEE FIGURE 2**

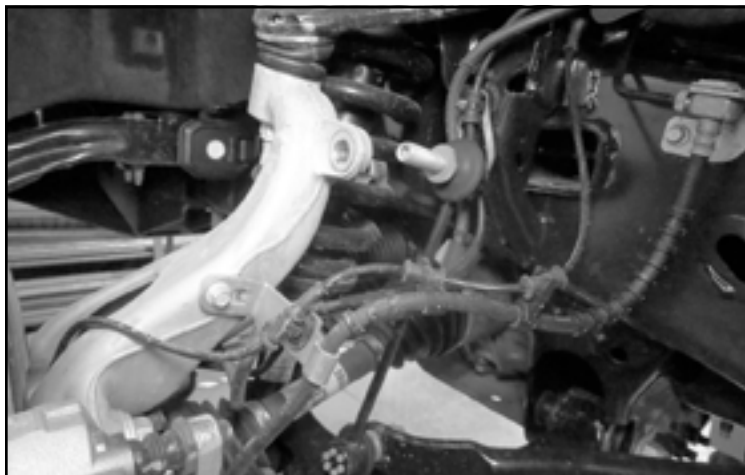

FIGURE 2 - STEP 4

5. Remove the axle shaft cover and nut. Save all hardware. **SEE FIGURES 3-4**



FIGURE 3 - STEP 5



FIGURE 4 - STEP 5

6. Disconnect the ABS lines and hoses from the bracket attached to the knuckle. Then remove the bracket from the knuckle. **SEE FIGURE 5-6**



FIGURE 5 - STEP 6

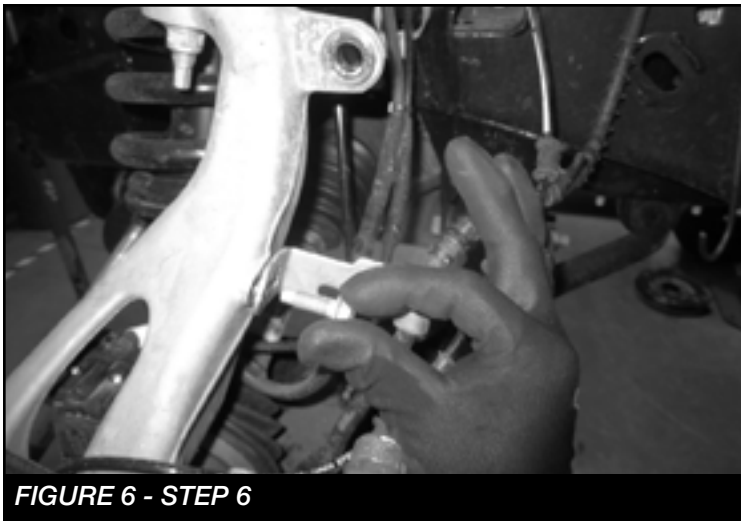

FIGURE 6 - STEP 6

7. Remove the brake caliper from the knuckle. Use a hanger or cable tie secure it to the frame. To prevent damage do not let the caliper hang freely. Save hardware. Remove the rotor and place in a safe area. **SEE FIGURES 8-9**



FIGURE 7 - STEP 7

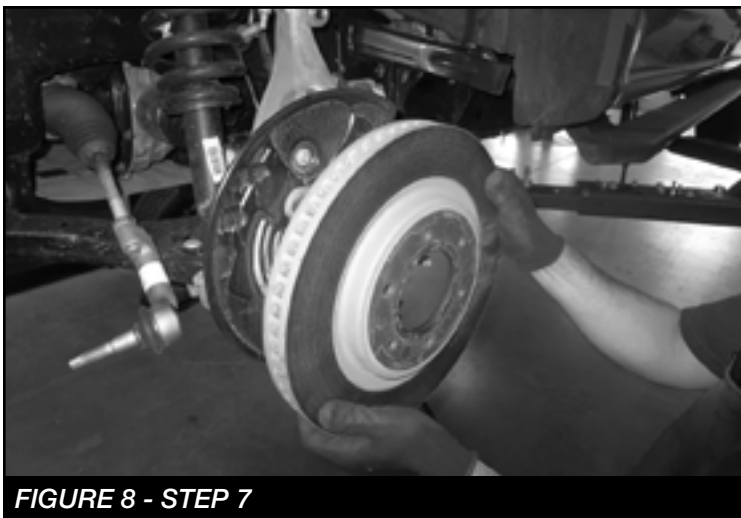

FIGURE 8 - STEP 7

8. Remove and save the three bolts attaching the dust shield to the knuckle. **SEE FIGURES 9-10**

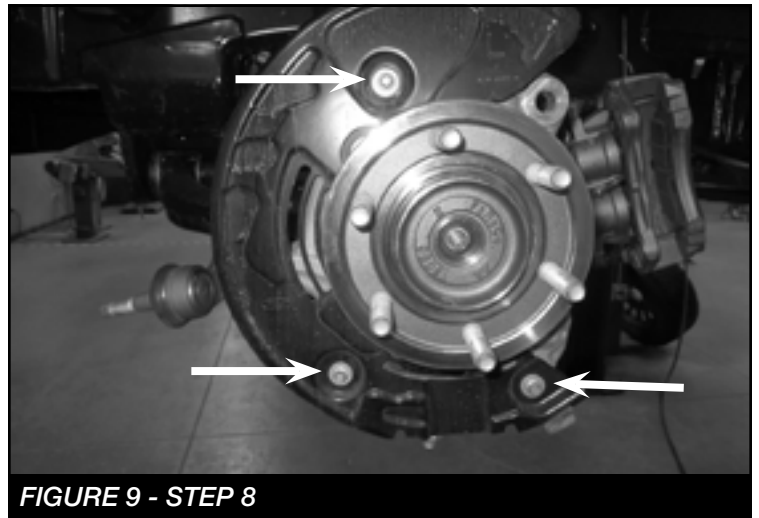

FIGURE 9 - STEP 8

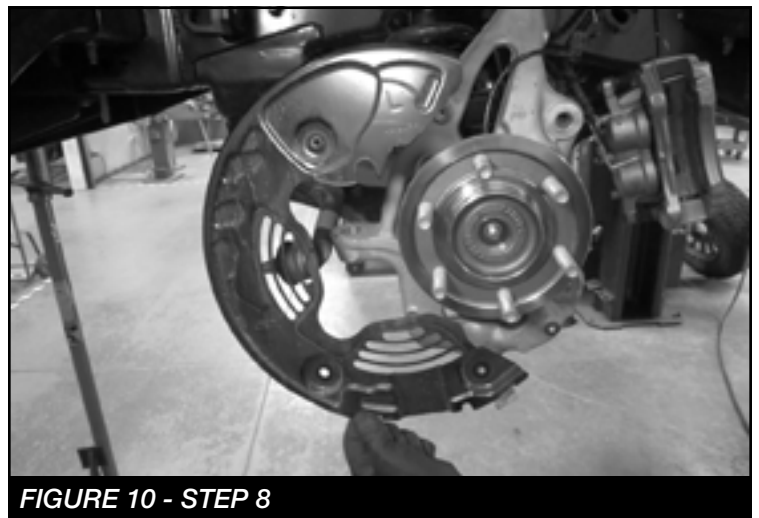

FIGURE 10 - STEP 8

9. Remove the wheel speed sensor from the top of the hub assembly. Save hardware. **SEE FIGURE 11**

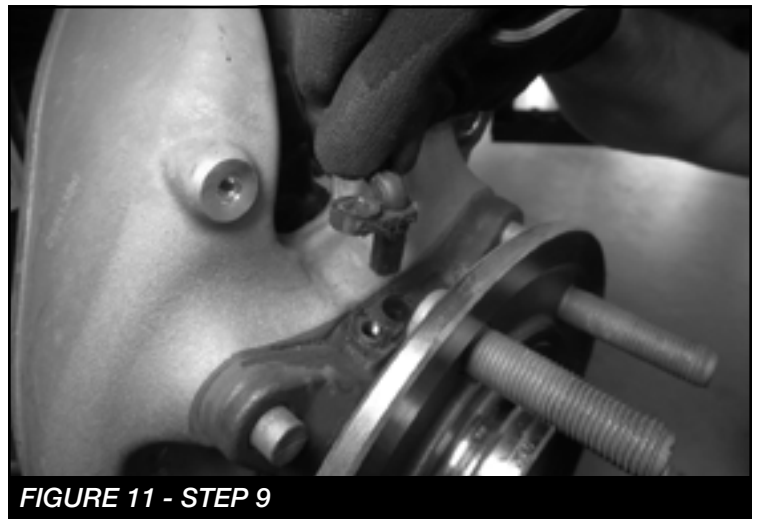

FIGURE 11 - STEP 9

10. Remove the four bolts attaching the 4wd hub actuator to the knuckle. Save hardware. **SEE FIGURES 12-13**

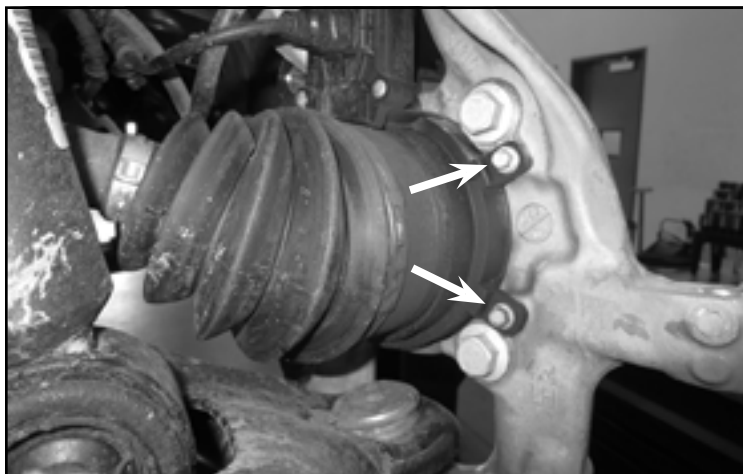

FIGURE 12 - STEP 10

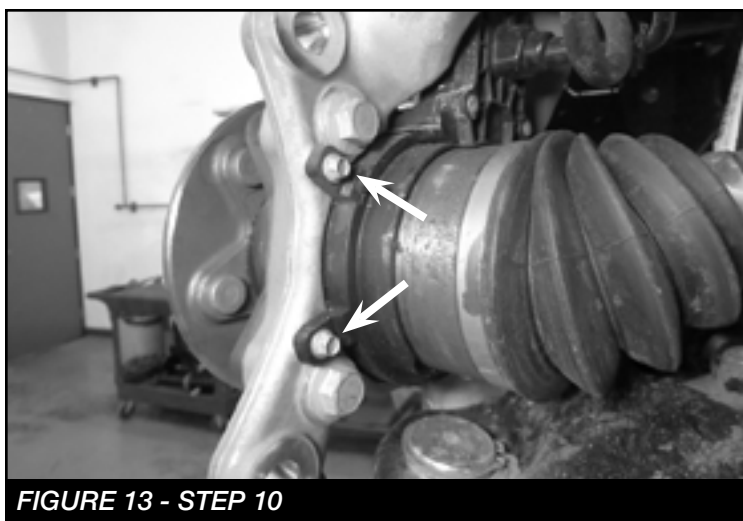

FIGURE 13 - STEP 10

11. Loosen the upper and lower ball joint nuts. Dislodge them by striking the knuckle with a large hammer next to each ball joint. Use care not to hit the ball joints. Then, remove the upper/ lower nuts and remove the knuckle from the vehicle. **NOTE: The 4wd hub actuator will stay on the cv shaft. SEE FIGURES 14-15**



FIGURE 14 - STEP 11



FIGURE 15 - STEP 11

12. Slide the 4wd hub actuator off the cv shaft and secure it to the frame. Be careful not to damage this part. **SEE FIGURES 16-17**



FIGURE 16 - STEP 12

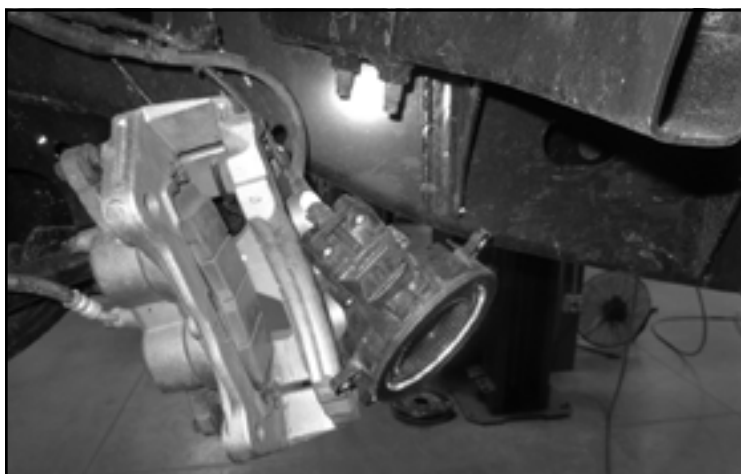

FIGURE 17 - STEP 12

13. Remove and save the three upper strut nuts as well as the two nuts attaching the strut to the lower control arm. Remove the factory coilover from the vehicle. **SEE FIGURES 18-20**

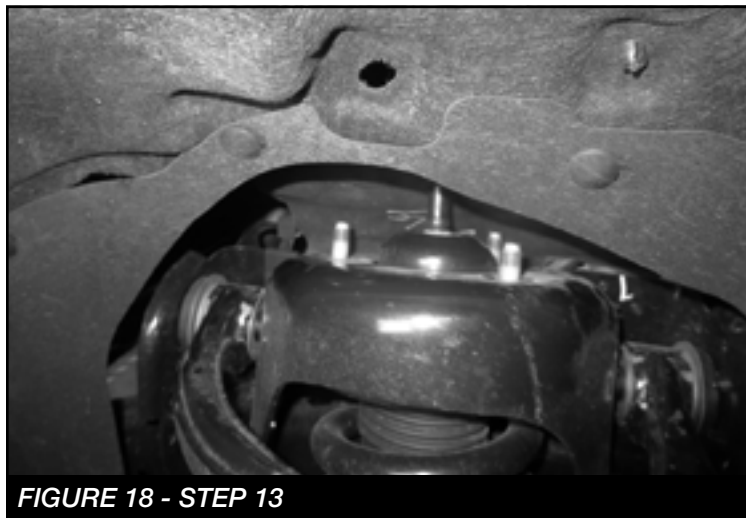

FIGURE 18 - STEP 13



FIGURE 19 - STEP 13

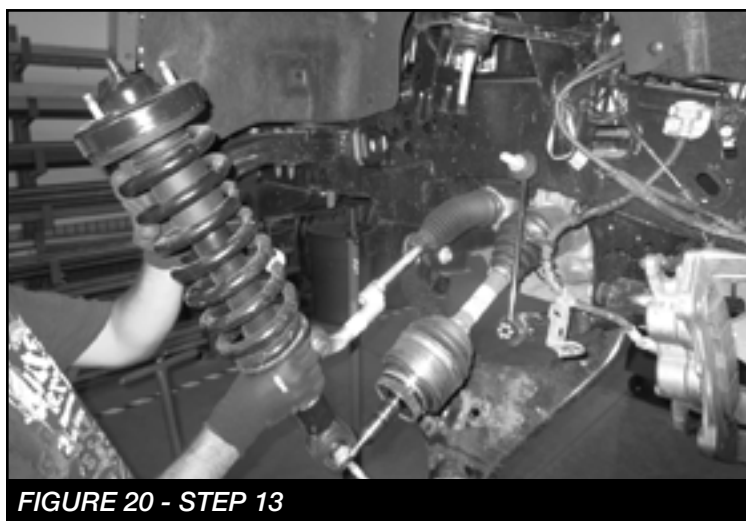

FIGURE 20 - STEP 13

14. Remove the lower control arm and save hardware. **SEE FIGURE 21**



FIGURE 21 - STEP 14

15. Repeat steps 3-14 on the passenger side.

16. Remove the sway bar from the vehicle save all hardware. **SEE FIGURE 22**



FIGURE 22 - STEP 16

17. Remove and discard the rear factory crossmember from the vehicle. **SEE FIGURE 23**



FIGURE 23 - STEP 17

18. Remove and save the front driveshaft hardware. Then, disconnect the driveshaft from the front differential. Secure it so it does not hang freely. **SEE FIGURE 24**



FIGURE 24 - STEP 18

19. Supporting the differential, remove the 3 differential mount bolts and save for re-installation. Remove the differential from the vehicle. **SEE FIGURE 25**

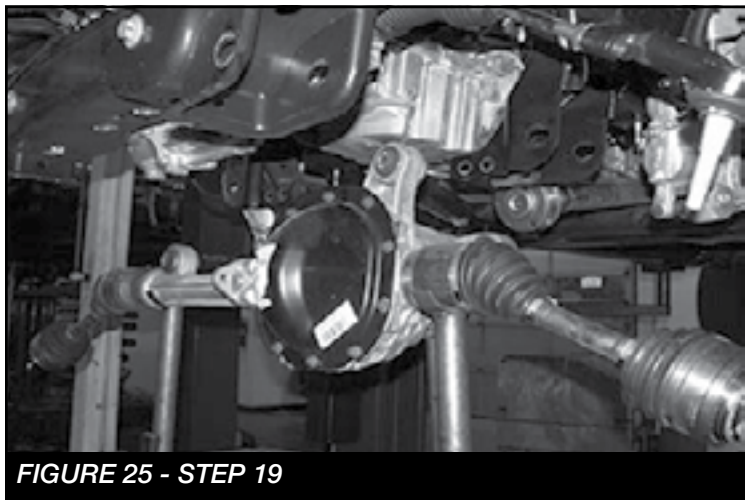

FIGURE 25 - STEP 19

20. Locate the driver side rear lower control arm pocket. Mark the frame 1" from the control arm pivot hole and 90 degrees to the bottom of the pocket where the cross member was mounted. Using a die grinder, cut all the way around the pocket. Discard removed portion of the pocket. **SEE FIGURES 26-27**

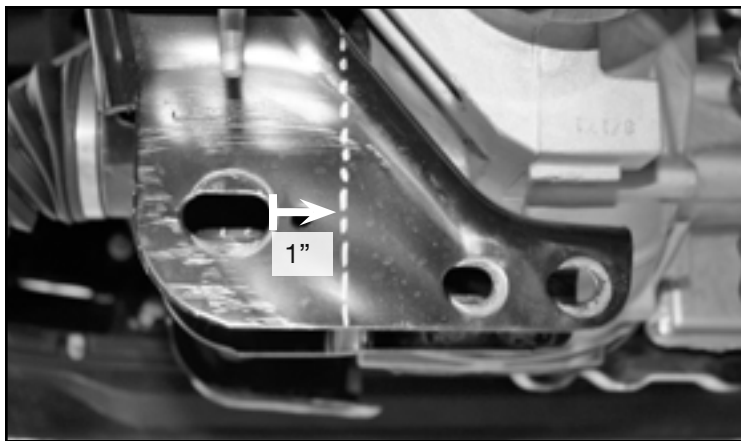

FIGURE 26 - STEP 20



FIGURE 27 - STEP 20

21. Refer to template 1 on page 19 for the next step. Cut out the template then tape onto the back side of the rear control arm pocket lining up the pivot hole and the edges. Using a paint pen mark the radius all the way to the upper edge of the template. Remove and cut using a cut off wheel or reciprocating saw. **SEE FIGURES 28-39**

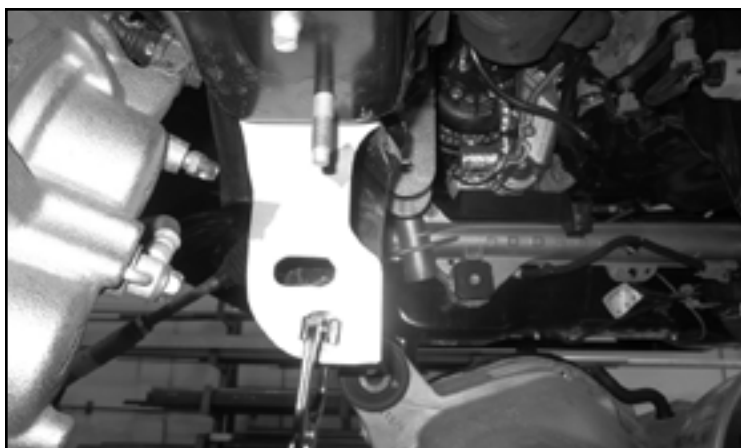

FIGURE 28 - STEP 21



FIGURE 29 - STEP 21

22. Locate the two Fabtech upper differential mounts (FT30378). These upper differential mounts will be placed into the factory upper differential mounts using the factory upper differential mount hardware. Leave the hardware loose in preparation for the differential installation. **SEE FIGURE 30**



FIGURE 30 - STEP 22

23. Reinstall the factory differential to the new drop brackets using the supplied 1/2" x 3-3/4" bolt, nut and washers on the driver side and the 1/2" x 3-1/2" bolt, nut and washers on the passenger side. **SEE FIGURES 31-32**

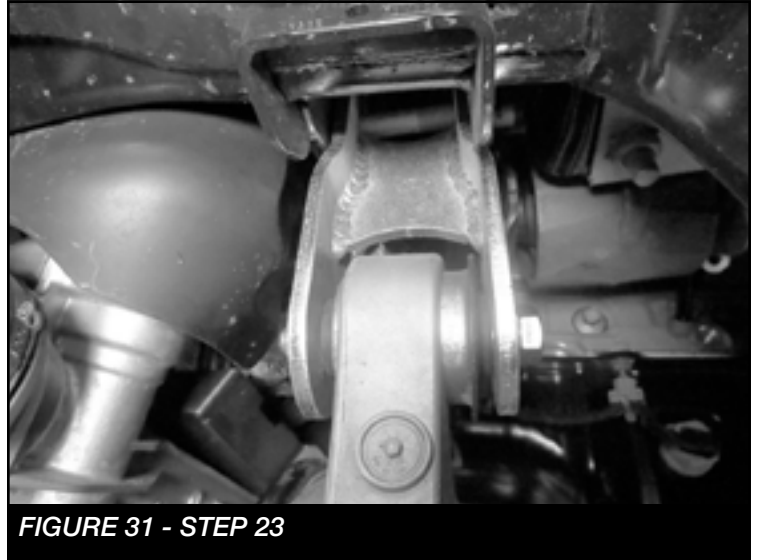

FIGURE 31 - STEP 23

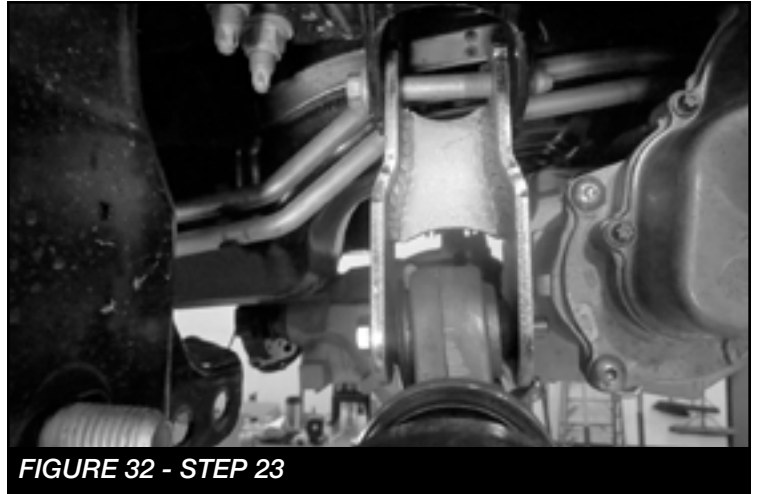

FIGURE 32 - STEP 23

24. Locate the Fabtech rear crossmember (FT30673BK) and rear diff plate (FT30646BK). Install the rear diff plate (FT30646BK) on the (FT30673BK) rear crossmember using the 3/8" hardware. Leave loose. Next, mount the crossmember using the M18 x 150mm bolt/hardware and 1/2" x 4" bolt/hardware on the driver side. Use the factory bolt/hardware on the passenger side. Leave all hardware loose. **NOTE: It may be necessary to jack up the rear of the diff to install the 18mm and 1/2" hardware. SEE FIGURES 33-34**

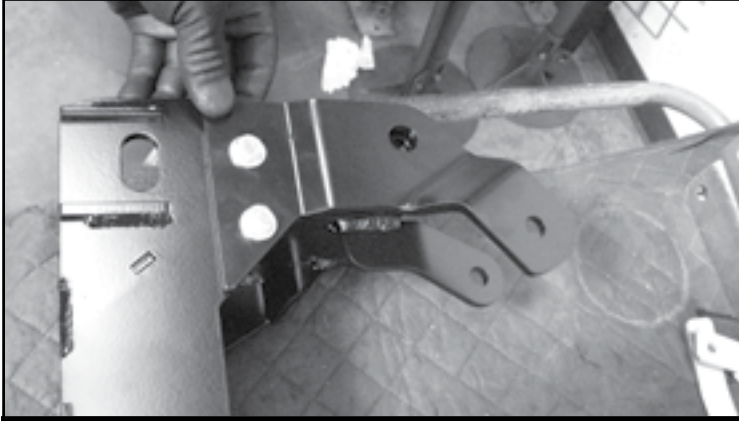

FIGURE 33 - STEP 24

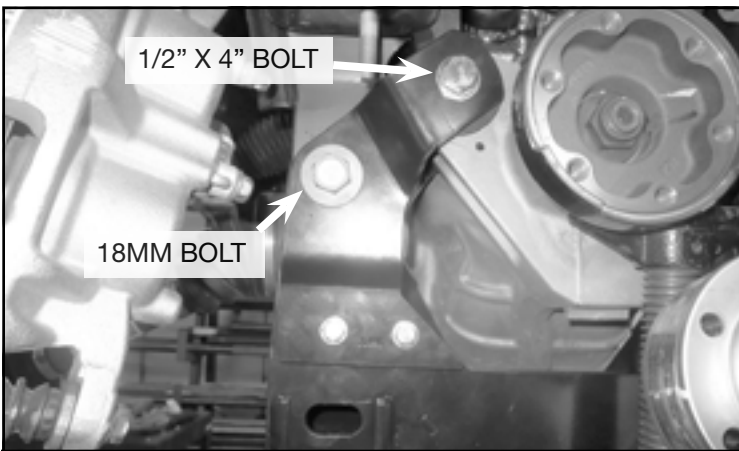

FIGURE 34 - STEP 24

25. Locate the center differential bracket (FT30645). Install two of the Fabtech (FT1020) bushings and one sleeve (FT181) into the barrel on the differential bracket. **SEE FIGURE 35**



FIGURE 35 - STEP 25

26. On the passenger axle tube that is attached to the differential, remove the rear and lower bolts to allow for the new center differential bracket to be mounted.
27. Install FT30645 (differential bracket) to the differential using three M10-1.5 x 45mm bolts, lock washers, and flat washers. Mount the front tab on the diff to the center bracket using one 1/2" x 2" bolt, nut and washers. Leave loose at this time. **SEE FIGURES 36-37**

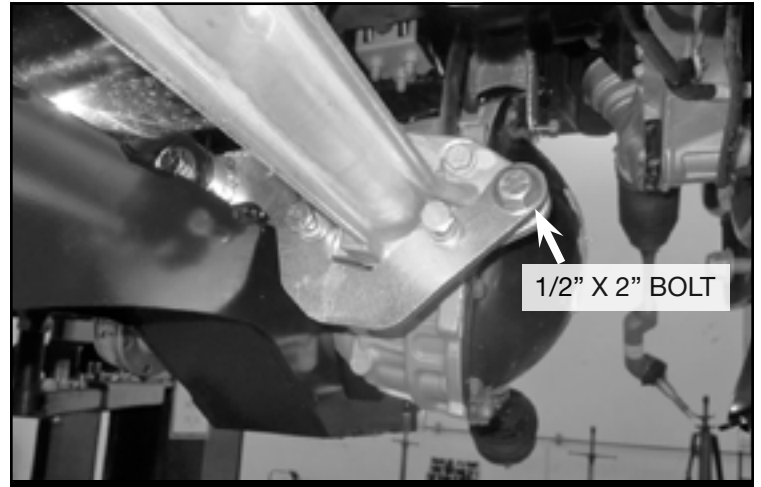

FIGURE 36 - STEP 25

28. Install a 1/2" x 3-3/4" bolt, washers and nut through the tabs on the rear crossmember and the bushing on the center bracket. Torque the M10-1.5 x 45mm bolts to 35 ft-lbs. Torque all the 1/2" hardware to 106 ft-lbs.. **SEE FIGURE 37**

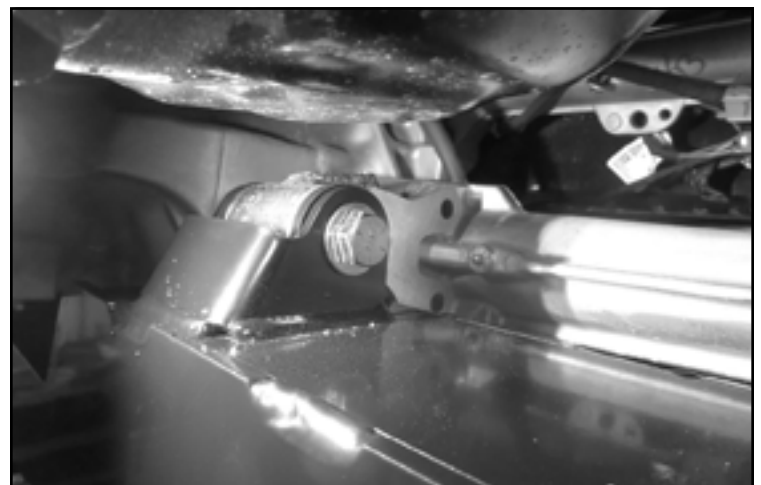

FIGURE 37 - STEP 28

29. Torque the upper differential bracket hardware to 68 ft-lbs and the lower bracket hardware to 106 ft-lbs.

30. Install FT30608 (Driveshaft spacer) using the factory hardware and torque to 35 ft-lbs. **SEE FIGURE 38**

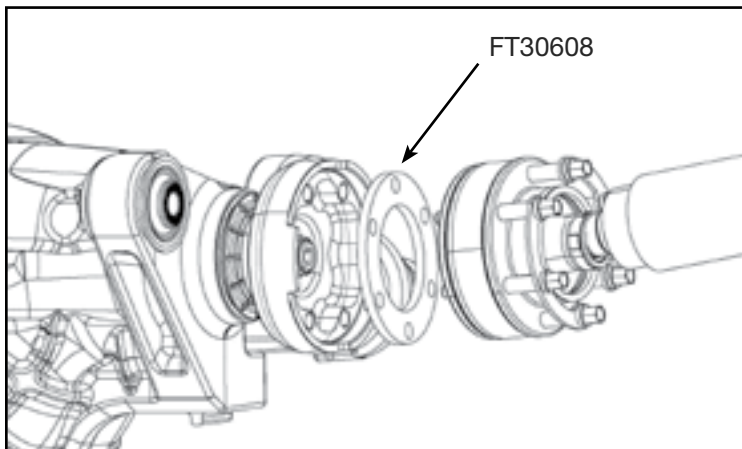

FIGURE 38 - STEP 30

31. Install the supplied 7" hose to the factory differential vent tube and back on to the differential. **SEE FIGURE 39**



FIGURE 39 - STEP 31

32. Install FT30644BK (Front crossmember) into the factory front control arm pockets using the factory hardware. Make sure the skid plate tab on the crossmember is facing the Fabtech rear crossmember. Leave the hardware loose at this time. **SEE FIGURE 40**



FIGURE 40 - STEP 32

33. Install FT30377BK (Skid Plate) to the front and rear crossmember using the supplied three 1/2" x 1-1/4" bolts, nuts and washers. Leave loose at this time. **SEE FIGURE 41**

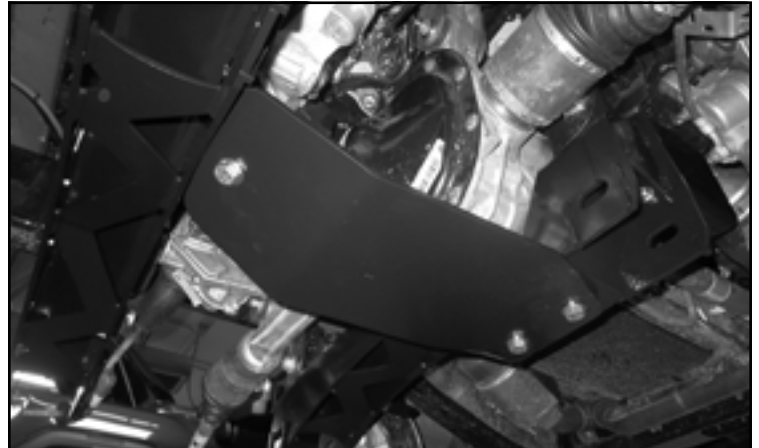

FIGURE 41 - STEP 33

34. Install the factory lower control arms into the Fabtech crossmembers using the hardware in the cam kit (FT292). Using the provided thread lock torque the cam bolts to 225 ft-lbs after alignment. Torque all crossmember bolts to 225 ft-lbs. Torque the 1/2" rear differential plate hardware as well as the skid plate hardware to 106 ft-lbs. **SEE FIGURES 42-43**

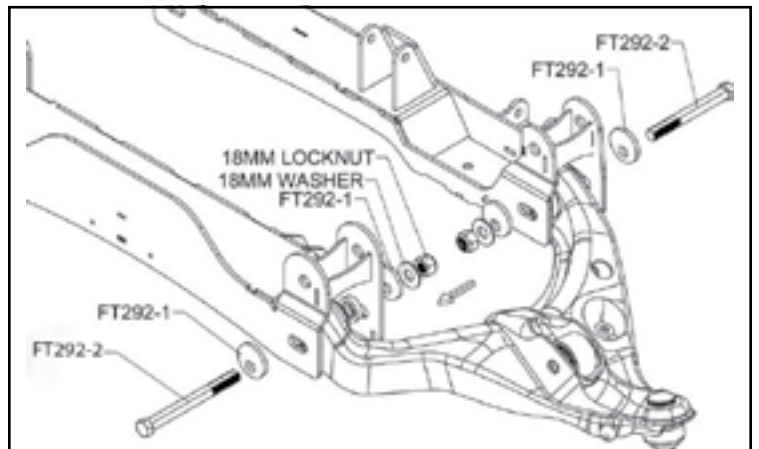

FIGURE 42 - STEP 34



FIGURE 43 - STEP 34

35. If installing Dirt Logic coilovers do so at this time using the instructions provided in the coilover box. Once finished, skip to STEP 43.

36. Remove the pressed in studs from the lower bar pin on the factory strut assembly. SEE FIGURE 44



37. Using a press, remove the factory bushing from the factory strut assembly.

38. Install two FT30946 (Aluminum Bushing) into the lower strut assembly. SEE FIGURES 45-46.

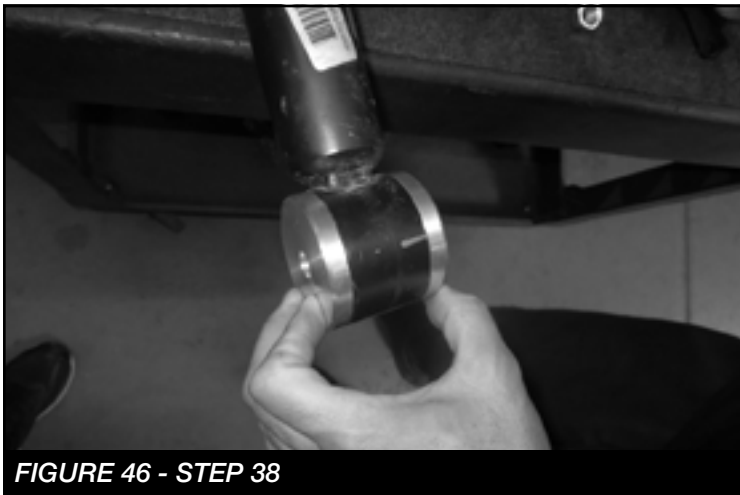
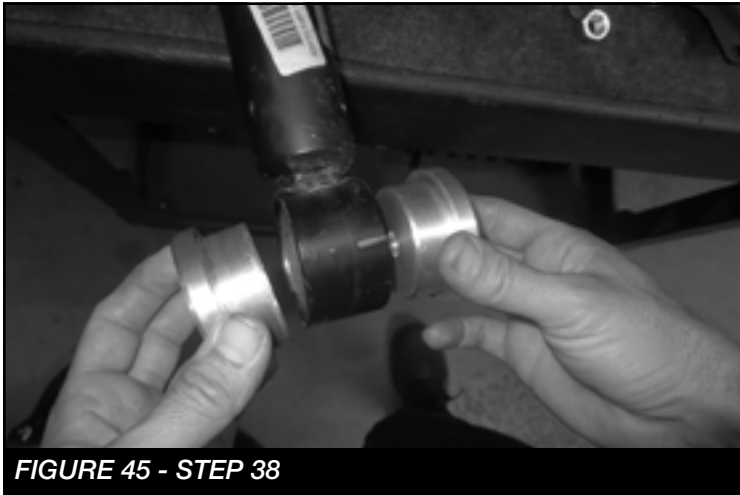

39. Install two FT20568BK (Shock brackets) and the FT30944 (Driver side lower strut mount) onto the driver side factory strut assembly using the supplied 5/16" x 1" bolts, nuts and washers as well as the 1/2" x 4" bolts, nuts and washers. SEE FIGURES 47-48



40. Repeat step 39 on the passenger side using FT30949 (Passenger lower strut mount)

41. Install the strut assembly into the upper tower using the factory hardware. Torque to 53 ft-lbs. **SEE FIGURE 49**

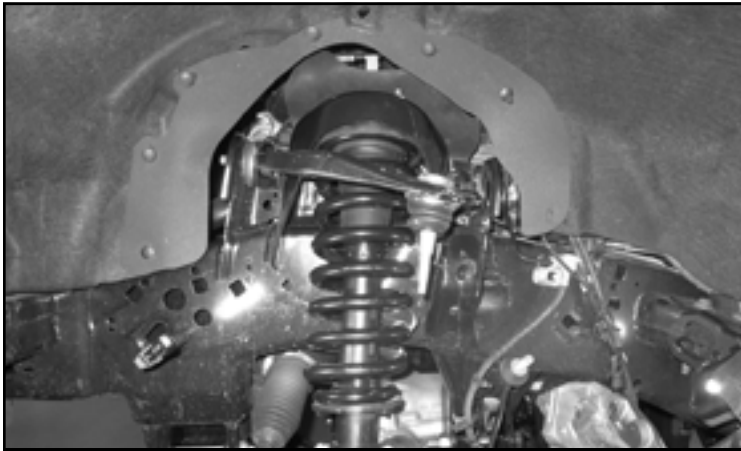

FIGURE 49 - STEP 41

42. Rotate the lower end of the strut assembly 90 degrees to line up the bar pin with the lower control arm. Attach the strut to the arm using the supplied 1/2" x 3" bolts, nuts and washers. Torque to 106 ft-lbs. **NOTE: The notch on the lower bracket should be on the cv axle shaft side. SEE FIGURE 50**



FIGURE 50 - STEP 42

43. Locate the factory spindles. Remove the four bolts attaching the hub assembly to the spindle. Then, remove the hub assembly on both spindles. **SEE FIGURES 51-52**



FIGURE 51 - STEP 43



FIGURE 52 - STEP 43

44. Install the factory hubs onto the new FT30942D & FT30942P (Driver & Passenger Spindles) using the factory hardware. Torque to 160 ft-lbs. **SEE FIGURE 53**



FIGURE 53 - STEP 44

45. Install the new Fabtech spindle onto the lower control arm. Hand tighten the lower ball joint nut. Slide the 4wd actuator onto the cv shaft then install the actuator to the spindle using the factory hardware. Torque to 7 ft-lbs. Install the shaft through the hub assembly. Install the spindle to the upper control arm using the factory nut. Torque the upper ball joint to 65 ft-lbs and the lower ball joint to 85 ft-lbs. **SEE FIGURES 54-56**

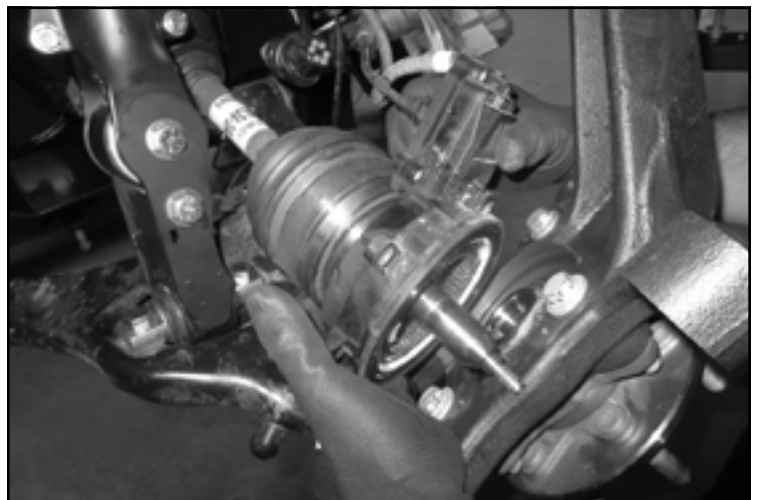

FIGURE 54 - STEP 45

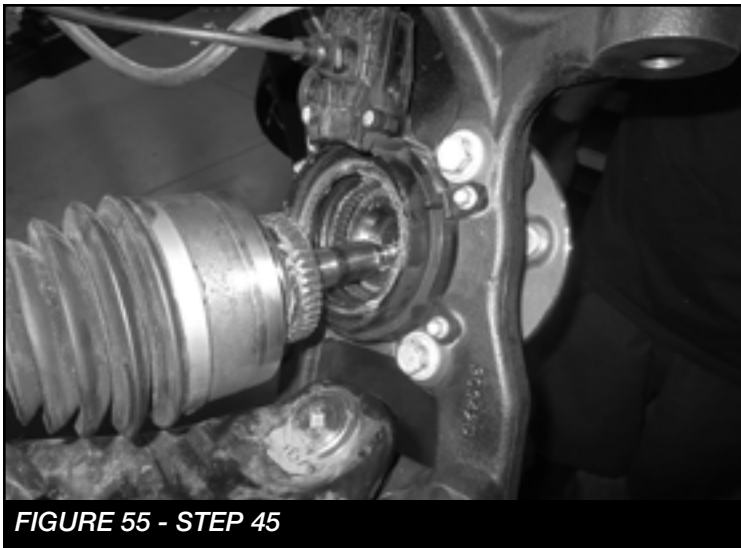

FIGURE 55 - STEP 45

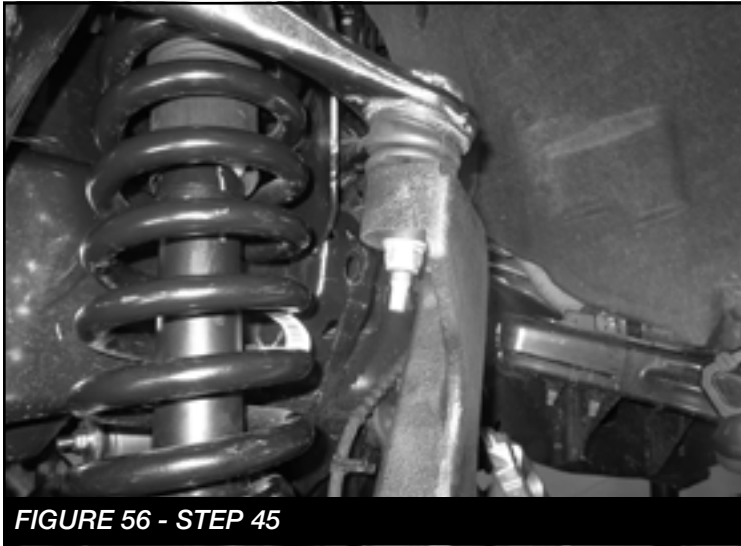

FIGURE 56 - STEP 45

46. Install the CV axle shaft nut and cover. Torque the 25 ft-lbs. **SEE FIGURE 57**

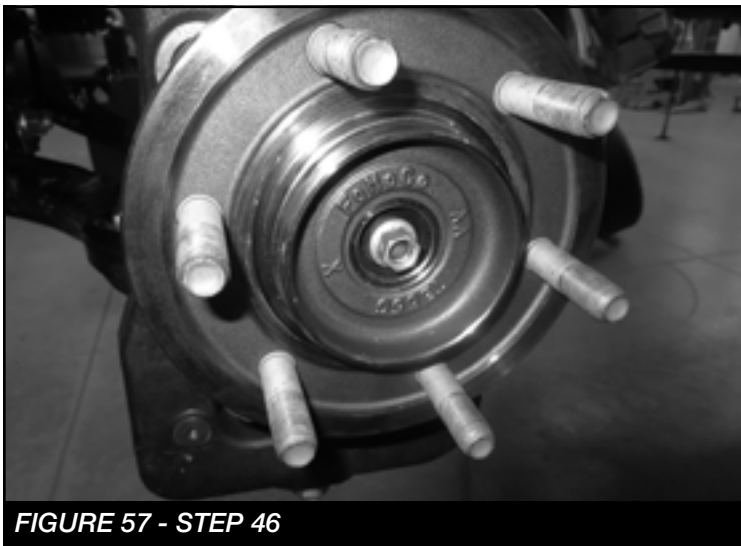

FIGURE 57 - STEP 46

47. Install the wheel speed sensor using the factory screw. Make sure the end of the sensor is clean. Torque to 7 ft-lbs. **SEE FIGURE 58**

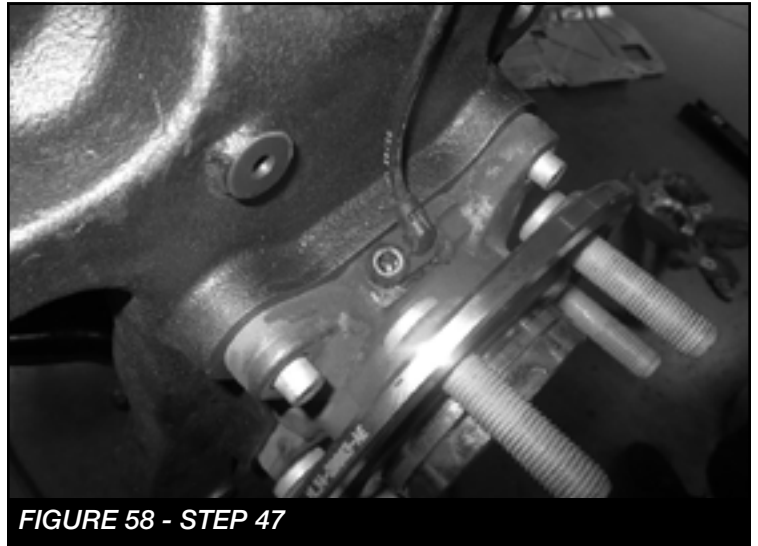

FIGURE 58 - STEP 47

48. Install the factory dust shield using the factory hardware. Torque to 14 ft-lbs. **SEE FIGURE 59**

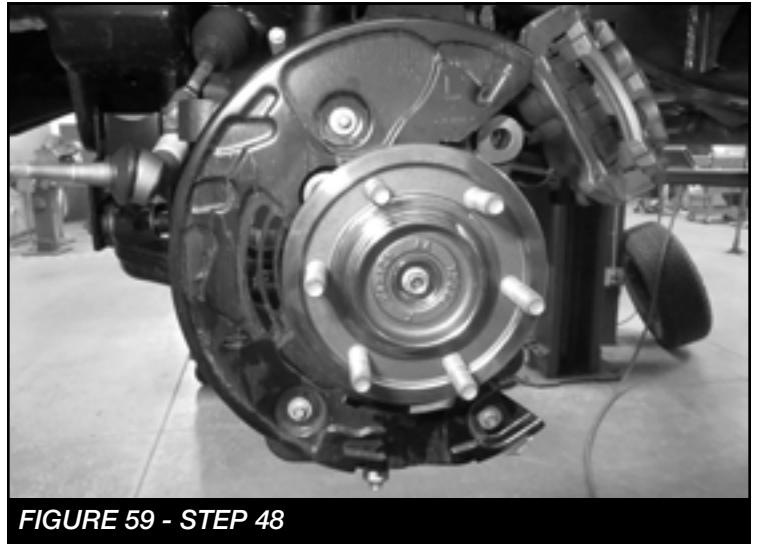

FIGURE 59 - STEP 48

49. Reinstall the factory brake rotor, followed by the brake caliper. Torque to 145 ft-lbs. Repeat steps on the passenger side. **SEE FIGURE 60-61**

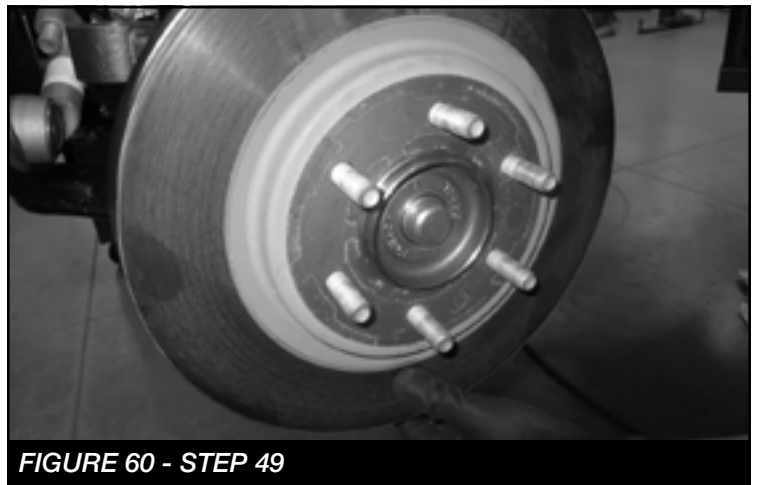

FIGURE 60 - STEP 49

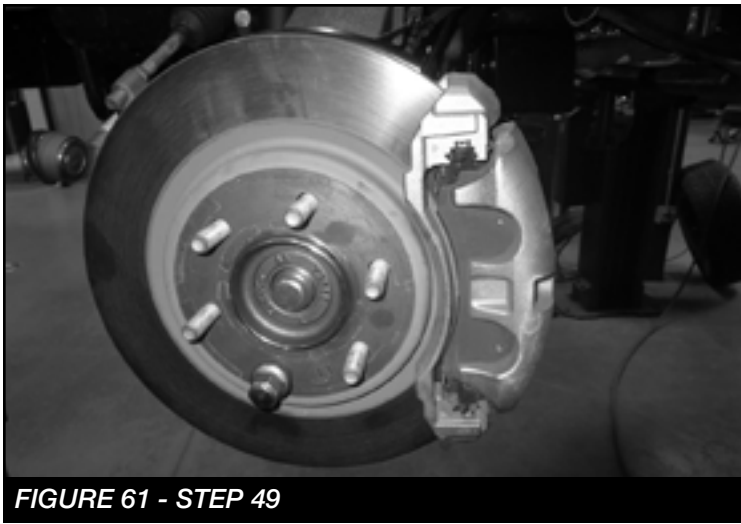

FIGURE 61 - STEP 49

50. Install FT30591 (Driver sway bar bracket) & FT30590 (Passenger sway bar bracket) to the frame using the factory hardware. **SEE FIGURE 62**



FIGURE 62 - STEP 50

51. Using the supplied 7/16" hardware install the factory sway bar to the new drop brackets. Next, reinstall the the end links to the new spindle using the factory hardware. Torque the factory and 7/16" hardware to 65 ft-lbs. **SEE FIGURE 63**

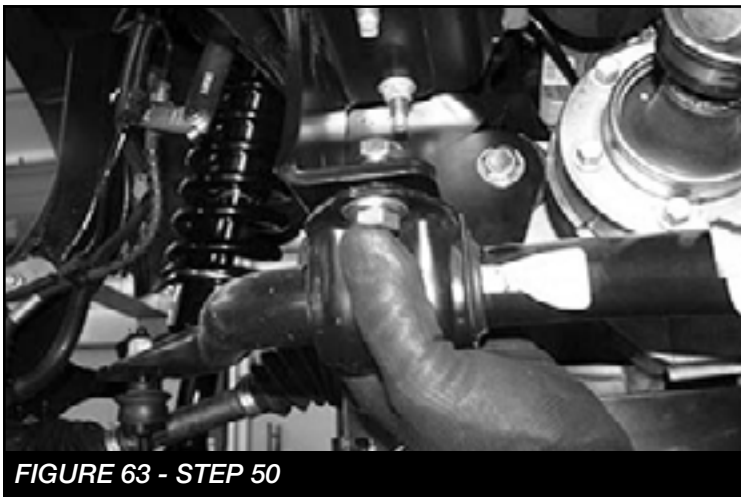

FIGURE 63 - STEP 50

52. Install FT30496 (Brake line bracket) to the frame using the factory hardware. Next, install the brake line to the new bracket using the supplied 5/16" hardware. Torque to 14 ft-lbs. **SEE FIGURE 64**

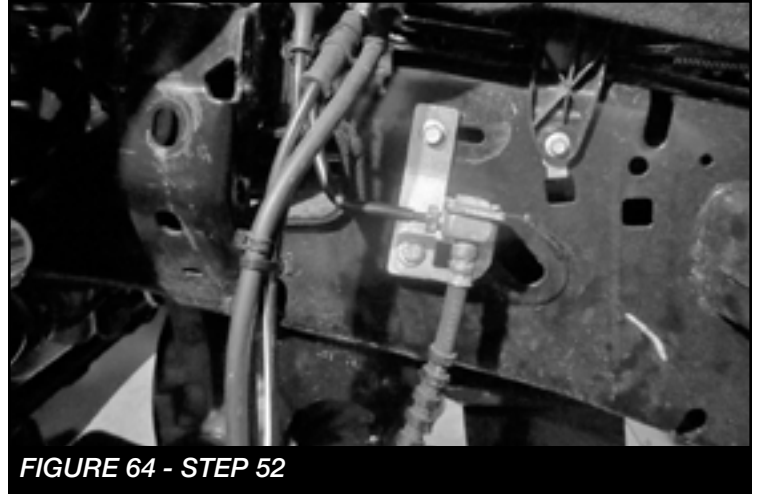

FIGURE 64 - STEP 52

53. Install the factory brake hose bracket to the new spindle using the factory bolt. **NOTE: The bracket may need to be bent slightly for proper fitment. SEE FIGURE 65**

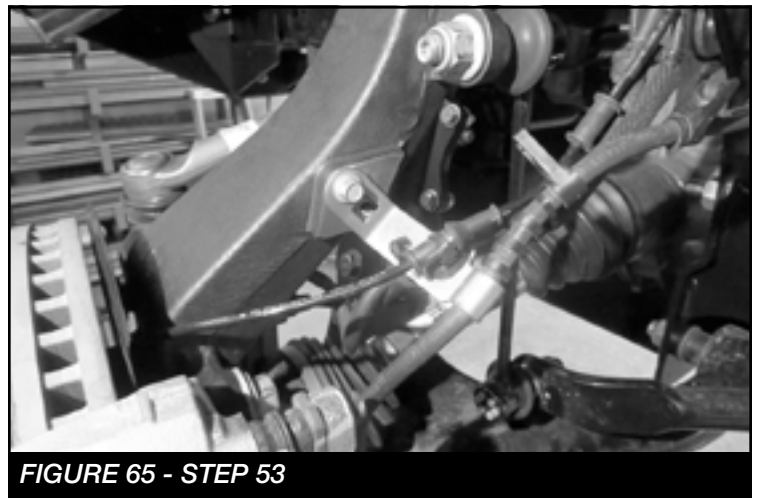

FIGURE 65 - STEP 53

54. Reconnect the tie rod end to the spindle using the factory hardware. Torque to 60 ft-lbs. **SEE FIGURE 66**

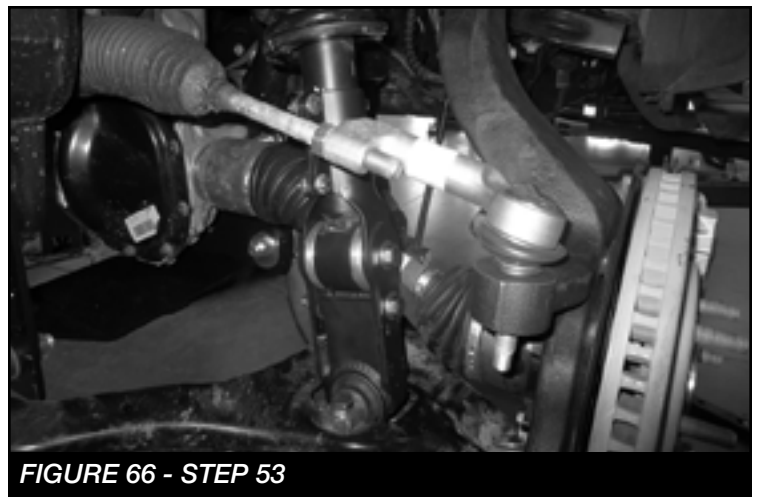

FIGURE 66 - STEP 53

REAR SUSPENSION

55. Jack up the rear end of the vehicle and support the frame rails with jack stands. Release the parking brake at this time. Supporting the rear differential, remove the rear shocks, u-bolts, blocks and lower axle down. Use care not to over extend the brake hose.

56. Locate the factory brake line mount on the driver side of the frame. Locate the supplied brake line bracket (FT70033) and attach the bracket between the factory frame mount and the factory brake line using the factory and supplied 5/16" hardware using the inside holes. **SEE FIGURE 55**

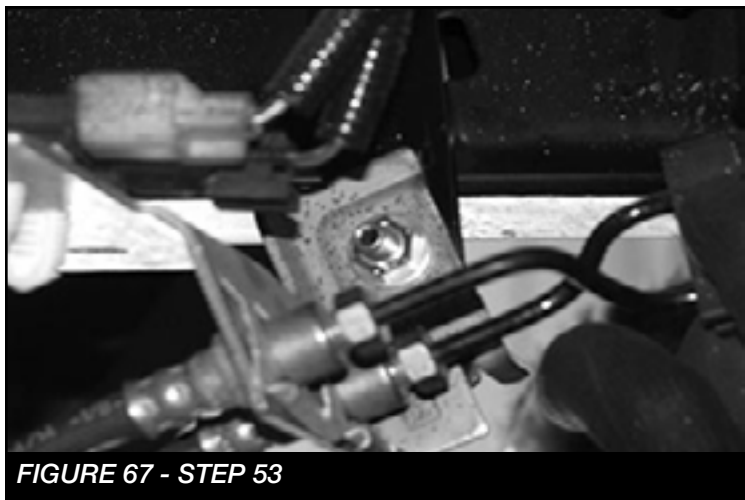

FIGURE 67 - STEP 53

57. Install the new rear lift blocks FTBK52. The extended bump stop perch will be facing inboard of the truck. Using the provided u-bolts, nuts and washers, align the axle, lift blocks, and springs and torque u-bolts to 90 ft-lbs. **SEE FIGURE 68**

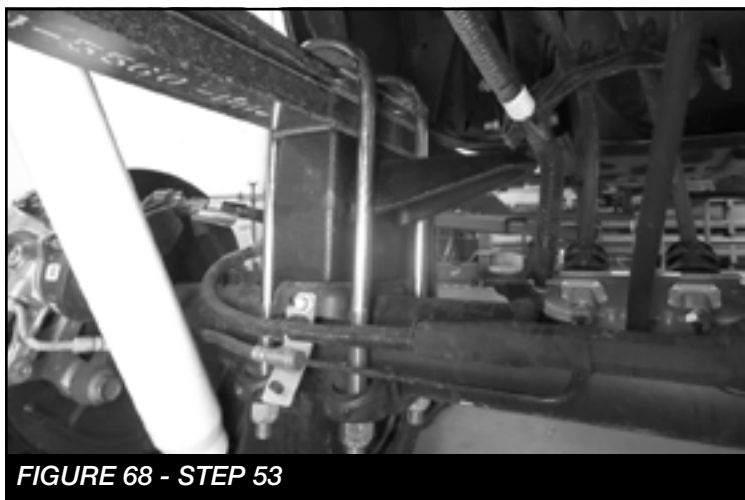

FIGURE 68 - STEP 53

58. Locate the Fabtech performance shocks (FTS7266), Stealth shocks(FTS6266) or Dirt Logic shocks (FTS810292). Install the shocks using the factory hardware and torque upper and lower bolts to 45 ft-lbs. **SEE FIGURES 57-58. NOTE: The FTS7266 and FTS6266 shocks are to be installed with the body down.**



FIGURE 69 - STEP 55

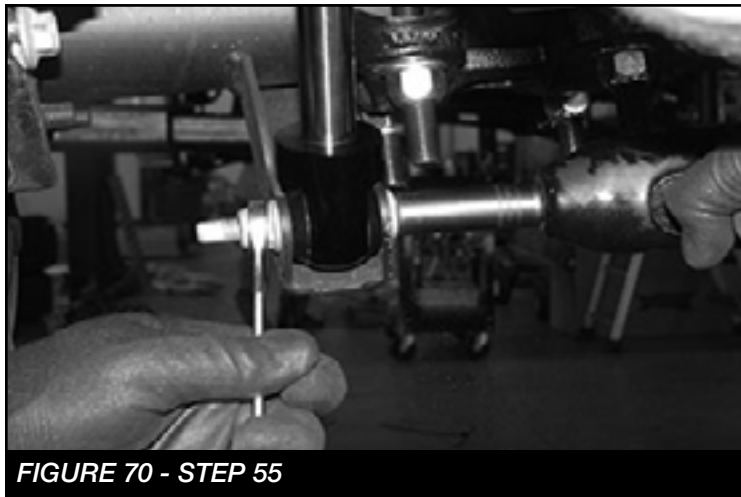
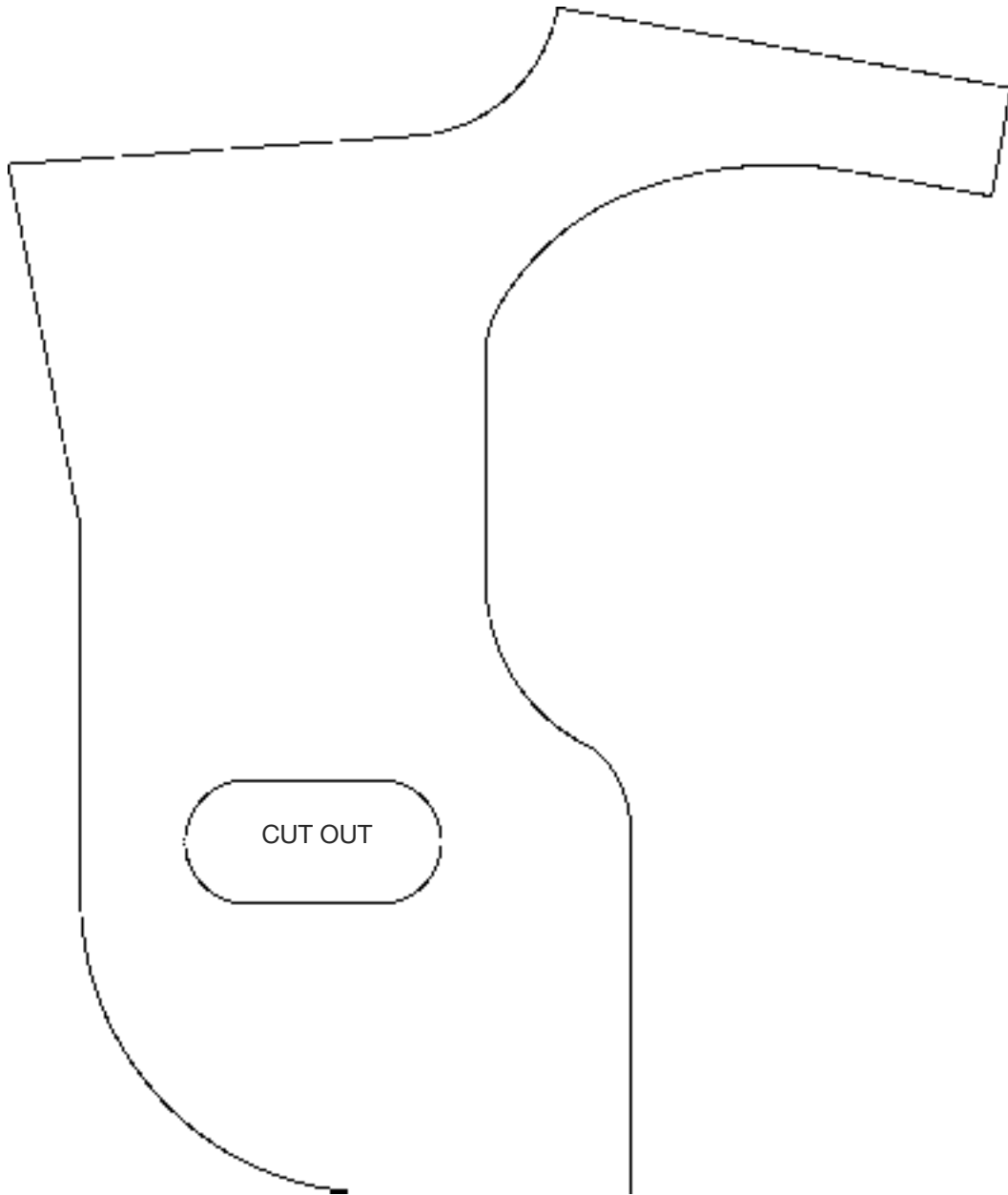

FIGURE 70 - STEP 55

59. Install tires and wheels and torque lug nuts to wheel manufacturer's specifications. Turn front tires left to right and check for appropriate tire clearance. **Note** - Some oversized tires may require trimming of the front bumper & valance.
60. Check front end alignment and set to factory specifications. Readjust headlights.
61. Recheck all bolts for proper torque. **RE-TORQUE ALL NUTS, BOLTS AND LUGS AFTER 50 MILES AND PERIODICALLY THEREAFTER UNTIL TORQUE VALUES ARE RETAINED.**
62. Recheck brake hoses, ABS wires and suspension parts for proper tire clearance while turning tires fully left to right.
63. Check the fluid in the front and rear differential and fill if needed with factory specification differential oil. **Note - some differentials may expel fluid after filling and driving. This can be normal in resetting the fluid level with the new position of the differential/s.**
64. Check ball joints, uniballs bearings, bushings and all steering components every 2500-5000 miles for wear and replace as required.
65. Install Driver Warning Decal. Complete product registration card and mail to Fabtech in order to receive future safety and technical bulletins on this suspension.
66. Review all included warnings and warranties with consumer

For technical assistance call: **909-597-7800**

CUT OUT TEMPLATE FOR USE ON STEP 21



- Product Warranty & Warnings -

Fabtech provides a Limited Lifetime Warranty to the original retail purchaser who owns the vehicle, on which the product was originally installed, for defects in workmanship and materials.

The Limited Lifetime Warranty excludes the following Fabtech items; bushings, bump stops, ball joints, Uniball bearings, tie rod ends, limiting straps, cross shafts, heim joints and driveshafts. These parts are subject to wear and are not considered defective when worn. They are warranted for 60 days from the date of purchase for defects in workmanship.

Dirt Logic take apart shocks are considered a serviceable shock with a 1-year warranty against any manufacturer's defects. If a shock fails within the initial year of ownership, the owner must ship the shock to Fabtech for inspection and service. If after examination the shock is determined to have failed due to neglect, damage caused by improper installation, or any reason other than "normal wear and tear," the owner of the shock will be responsible for all service costs. Costs include labor, parts, and shipping. Service seal kits are available separately for future maintenance. All other shocks are covered under our Limited Lifetime Warranty.

Fabtech does not warrant any product for finish, alterations, modifications and/or installation contrary to Fabtech's instructions. Alterations to the finish of the parts including but not limited to painting, powder coating, plating and/or welding will void all warranties. Some finish damage may occur to parts during shipping, which is considered normal and is not covered under warranty.

Fabtech products are not designed nor intended to be installed on vehicles used in race applications or for racing purposes or for similar activities. This warranty does not include coverage for police, taxi, first responder vehicles, race vehicles, or vehicles used for government, commercial or fleet purposes. Also excluded from this warranty are sales outside of the United States of America.

Installation of most suspension products will raise the center of gravity of the vehicle and will cause the vehicle to handle differently than stock. It may increase the vehicle's susceptibility to a rollover, on road and off road, at all speeds. Extreme care should be taken to operate the vehicle safely at all times to prevent rollover or loss of control resulting in serious injury or death.

Oversized tires and wheels may decrease the vehicle's braking capacity. Drivers should always brake early and be aware of the increased the stopping distance of the vehicle. Drivers should adjust their driving habits to the effectiveness of the braking. Adjust your driving habits to these changes.

Failure to drive safely may result in serious injury or death to driver and passengers. Driver and passengers must ALWAYS wear your seat belts, avoid quick sharp turns and other sudden maneuvers