



Installation Instructions



6" Performance Suspension System 2006-07 Toyota FJ Cruiser 2WD & 4WD FTS26016BK / FTS26017BK / FTS26018BK

Fabtech Motorsports 4331 Eucalyptus Ave. Chino, CA 91710
Tech Line 909-597-7800 Fax 909-597-7185 Web www.fabtechmotorsports.com



**2006-07 Toyota FJ Cruiser 2WD & 4WD
FTS26016BK / FTS26017BK / FTS26018BK**

PARTS LIST:

Qu a	Part #	Description
	FTS26016BK	Box 1 Front
1	FTS70097D	Driver Spindle
1	FTS70097P	Pass. Spindle
2	FT70099	Tie Rod End
2	FT70066BK	Impact Tube
2	FT70059BK	Impact Tube Mount
2	50133501081	1/2"-13 X 3 1/2" Hex Bolt
1	FT70063	Spindle Brake Line Brkt Drv.
1	FT70064	Spindle Brake Line Brkt Ps.
1	FT70100BK	Sway Bar Drop Driver
1	FT70101BK	Sway Bar Drop Passenger
2	FT70106	Sway Bar Drop Nut Tab
2	FT70105	Sway Bar End Link
4	FT95023	1/2" Heim
2	FT70102	Sway Bar Hat
2	FT70103	Mis-Alignment Low Pro
4	FT95020 or FT70159	Mis-Alignment
2	FT70094	Body Mount Weld In Plate
2	FT70061	Front Brake Line Bracket
1	FT70069	Front Hardware Kit
2	FT133	Sleeve, Impact Strut Brkt
1	FT1044	Bushing Kit
1	FT90087	Bushing Kit
2	FTS88	Bump Stops
2	FT260161	Instruction Sheet

Qu a	Part #	Description
	FTS26010BK	Coil Spacer Box
2	FT70055BK	Coil Spacer

Qu a	Part #	Description
	FTS26017BK	Box 2 Front
1	FT70082BK	Front Crossmember
1	FT70083BK	Rear Crossmember
2	FT70098	Crssmber Weld in Plate
1	FT70058BK	Skid Plate
1	FT70053	Drv. Lower Diff Bracket
1	FT70054	Pass. Lower Diff Bracket
1	FT70056BK	Drv. Frt. Bump Stop
1	FT70057BK	Pass. Frt. Bump Stop

Qu a	Part #	Description
	FTS26018BK	Box 3 Rear
2	FT70084BK	Upper Link Arm D/P
2	FT70085BK	Lower Link Arm D/P
1	FT70086BK	Driver Coil Spacer
1	FT70086BK	Passenger Coil Spacer
1	FT70088BK	Trac Bar Bracket
1	FT70096	Trac Bar Brk. Nut Tab
1	FT70089	Brake Line Bracket
2	FT70090BK	Sway Bar End Link
2	FT70093BK	Rear Bump Stop Bracket
1	FT50116	Sway Bar Bushing Kit
1	FT50089	Sway Bar Sleeve Kit
1	FT70091	Front & Rear Hardware Kit
2	FT83239	Rear Shock Spacer
1	FT70092	Rear Bushing Kit
2	103600007	Rear Shock Bushing



**2006 Toyota FJ Cruiser 2WD & 4WD
FTS26012BK / FTS26013BK / FTS26014BK**

FT70069 Hardware Kit -		
Qu a	Description	Location
2	3/4"-10 x 4 1/2" Bolt	Front Crossmember
2	3/4"-10 C-Lock	
4	3/4" SAE Flat Washer	
2	9/16"-12 x 5" Bolt	Rear Crossmember
2	9/16"-12 C-Lock	
4	9/16" SAE Flat Washer	
2	5/16"-18 x 1 1/4" Bolt	Diff Skid Plate
2	5/16"-18 C-Lock	
4	5/16" SAE Flat Washer	
1	1/2"-13 1 1/2" Bolt	
1	1/2"-13 C-Lock	
2	1/2" SAE Flat Washer	
2	1/2"-13 x 4" Bolt	Diff Mounts
2	1/2"-13 C-Lock	
4	1/2" SAE Flat Washer	
4	3/8"-16 x 1 1/4" Bolt	Bump Stop Brkt
4	3/8"-16 C-Lock	
8	3/8" SAE Flat Washer	
2	10mmx1.25 x 25mm Bolt	
2	10mm Flat Washer	
2	3/8"-16 Nyloc	Bump Stop
2	3/8" SAE Flat Washer	
4	3/8"-16 x 1 1/4" Bolt	Sway Bar & Brkt
4	3/8"-16 C-Lock	
8	3/8" SAE Flat Washer	
6	3/8"-16 C-Lock	Coil Spacers
6	3/8" SAE Flat Washers	
8	1/8" Cotter Pin	
2	Thread Locking Cmpnd	

FT70091 Hardware Kit -		
Qu a	Description	Location
4	7/16"-14 x3 1/2" Bolt	Impact Tube
4	7/16"-16 C-Lock	
8	7/16" SAE Flat Washer	
2	1/2"-13 x 3" Hex Bolt	Impact Tube Bracket
2	1/2"-13 C-Lock	
4	1/2" SAE Flat Washer	
2	5/16"-18 x 1" Bolt	Frnt Brake Line Drop
2	5/16"-18 C-Lock	
4	5/16" SAE Flat Washer	
12	1/4"-20 x 3/4" Bolt	ABS & Brake Line Clmps
12	1/4" Split Washer	
12	1/4" SAE Washer	
2	3/8"-16 x 1 1/4" Bolt	Front Sway Bar Bracket
2	3/8" SAE Flat Washer	
2	3/8" Split Washer	
2	3/8"-16 x 2 1/4" Bolt	Sway Bar End Link (btm)
2	3/8"-16 x 3" Bolt	Sway Bar End Link (top)
4	3/8"-16 C-Lock Nut	
6	3/8" SAE Flat Washer	
4	1/2"-20 Jam Nut	
6	3/8"-16 x 1 1/4" Bolt	Coil Spacers
6	3/8"-16 C-Lock Nut	
12	3/8" SAE Flat Washer	
4	8mm x 1.25x30 mm Bolt	
4	8mm Split Washer	
4	8mm Flat Washer	
4	5/16"-18 x 1" Bolt	Bumpstops
4	5/16"-18 C-Lock Nut	
8	5/16" SAE Flat Washer	
1	9/16"-12 x 3 1/2" Bolt	Trac Bar Bracket
1	9/16"-12 C-Lock Nut	
2	9/16" SAE Flat Washer	
1	1/2"-13 x 1 1/2" Bolt	
1	1/2" Split Washer	
1	1/2" SAE Flat Washer	
3	5/16"-18 x 3/4" Bolt	Brake & E-Brk Cbl Brkt
3	5/16"-18 C-Lock Nut	
6	5/16" SAE Flat Washer	

2	12mm x 1.75x70mm Bolt	Sway Bar End Link
2	12mm x 1.75 C-Lock Nut	
6	1/2" USS Flat Washer	
2	3/8"-24 C-lock Nut	
7	Adel Clamp (FTCLAMP)	ABS Lines



**2006 Toyota FJ Cruiser 2WD & 4WD
FTS26016BK / FTS26017BK / FTS26018BK**

READ ALL INSTRUCTIONS THOROUGHLY FROM START TO FINISH BEFORE BEGINNING INSTALLATION! IF THESE INSTRUCTIONS ARE NOT PROPERLY FOLLOWED, SEVERE FRAME, DRIVELINE AND / OR SUSPENSION DAMAGE MAY RESULT.

NOTE: PRIOR TO THE INSTALLATION OF THIS SUSPENSION SYSTEM A FRONT END ALIGNMENT MUST BE PERFORMED AND RECORDED. DO NOT INSTALL THIS SYSTEM IF THE VEHICLE ALIGNMENT IS NOT WITHIN FACTORY SPECIFICATIONS. CHECK FOR FRAME AND SUSPENSION DAMAGE PRIOR TO INSTALLATION.

CHECK ALL PARTS INCLUDED IN THIS KIT TO THE PARTS LIST ABOVE BEFORE BEGINNING INSTALLATION OF THIS KIT. IF ANY PARTS ARE MISSING, CONTACT FABTECH AT 909-597-7800

DO NOT ALTER THE FINISH OF THESE COMPONENTS, EXAMPLE- CHROMING, ZINC PLATING OR PAINTING. CHANGING THE FINISH CAN CAUSE STRUCTURAL FATIGUE OF COMPONENTS.

THIS SUSPENSION SYSTEM WILL NOT WORK ON TRUCKS EQUIPPED WITH ELECTRONIC CONTROLLED SHOCK ABSORBERS

IF INSTALLING THE OPTIONAL DIRT LOGIC COILOVER, RECORD THE RIDE HEIGHT OF THE VEHICLE SO THAT THE PROPER RIDE HEIGHT CAN BE DONE WHEN COMPLETED

YOU MUST RUN A 17X8 RIM OR LARGER WITH A 4 5/8" BACK SPACING WITH THIS KIT FOR PROPER WHEEL CLEARANCE. 16" RIM WILL NOT FIT THE TRUCK ONCE THE KIT IS INSTALLED.

WELDING REQUIRED

VERIFY DIFFERENTIAL FLUID IS AT MANUFACTURES RECOMMENDED LEVEL PRIOR TO KIT INSTALLATION. INSTALLATION OF THE KIT WILL RE-POSITION THE DIFFERENTIAL AND THE FILL PLUG HOLE MAY BE IN A DIFFERENT POSITION. (FOR EXAMPLE, IF THE MANUFACTURE RECOMMENDS 3 QUARTS OF FLUID, MAKE SURE THE DIFF HAS 3 QUARTS OF FLUID). CHECK YOUR SPECIFIC MANUAL FOR CORRECT AMOUNT OF FLUID.

TOOL LIST: (NOT INCLUDED)

- FLOOR JACK & JACK STANDS
- ASSORTED METRIC AND S.A.E SOCKETS, & WRENCHES
- LARGE C CLAMP OR C CLAMP VISE GRIPS
- DIE GRINDER WITH CUTOFF WHEEL OR SAWZALL

- TORQUE WRENCH
- MIG WELDER
- COIL SPRING COMPRESSOR

FRONT SUSPENSION INSTRUCTIONS:

1. Disconnect the negative terminal on the battery. With the vehicle on level ground, set the emergency brake and block the rear tires. Jack up the front end of the truck and support the frame rails with jack stands. **NEVER WORK UNDER AN UNSUPPORTED VEHICLE!** Remove the front tires.
2. Working from both sides of the truck, locate and remove the factory skid plate and brackets. Discard skid plate and hardware, these will not be reinstalled on the truck. SEE PHOTO BELOW.



3. Remove factory mud flaps off front of the vehicle and discard.
4. Remove the nut from the tie rod ends. Disconnect the tie rod ends from the steering knuckle by striking the knuckle with a large hammer to dislodge the tie rod end. **Use care as to not hit the threads on the tie rod end with the hammer as you will damage them.** Save all hardware. SEE PHOTO BELOW



5. Remove the sway bar end links from the factory steering knuckles and leave connected to the bar. Then remove the bar from the truck. Save the bar and end links with all hardware. SEE PHOTOS BELOW.





6. Remove the brake caliper from the steering knuckle and hang out of the way. **Do not allow the brake caliper to hang from brake line.** Remove the brake line brackets from the knuckle. Trucks equipped with ABS brakes, unbolt the ABS line and disconnect from steering knuckle and the upper control arm. Remove the bracket from the ABS line and discard. SEE PHOTO ON NEXT PAGE



7. Remove the brake rotor, save all hardware.
8. Support the lower A-Arm with a floor jack. Loosen the upper ball joint nut. Disconnect the upper ball joint from the upper control arm by striking the knuckle with a large hammer next to the ball joint to dislodge the ball joint. **Use care not to hit the ball joint when removing.** Remove and save factory castle nut.
9. Remove the castle nut and two bolts on each side connecting the lower ball joint assembly to the knuckle. Save the Castle nut, as you will reuse it. Remove spindle assembly from truck. Remove remaining portion by striking with a large hammer next to the ball joint to dislodge. **Use care not to hit the ball joint when removing.** SEE PHOTO BELOW.

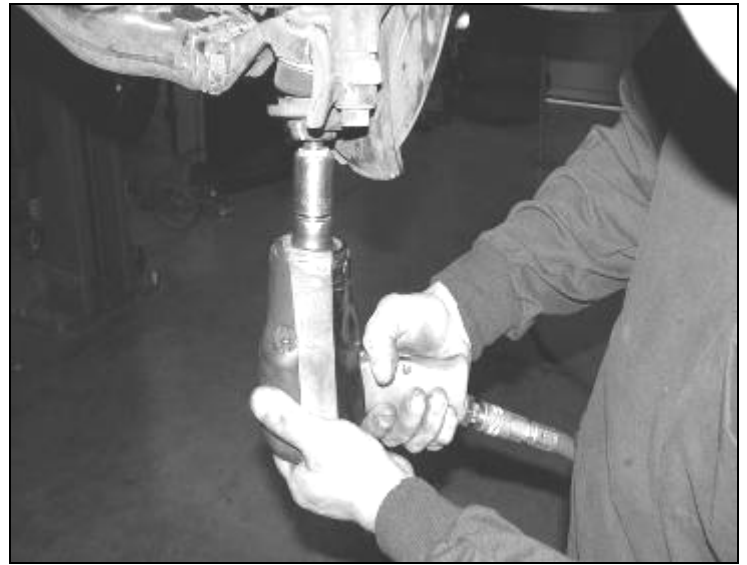

10. Remove the three upper nuts from the top of the strut assembly then the lower bolt from the strut at the lower control arm. Remove the shock assembly as one complete unit and save with the hardware if installing the Basic Kit (coil spacer), discard if installing Dirt Logic coilovers. SEE PHOTOS IN NEXT COLUMN.



11. Remove and save the factory lower control arms with the hardware.

Skip steps Twelve and Thirteen for 2wd model trucks

12. Disconnect the front drive shaft ONLY from the differential, do not disconnect from the transfer case. Save hardware. **Do not allow drive shaft to hang freely.**
13. Support the front differential with a transmission or floor jack. Disconnect all electrical, vacuum lines, and breather lines from the differential. Remove the rear differential nut and save as you **will** reuse it during assembly. Remove the two front differential bracket bolts from the frame. Discard the bolts, as you **will not** reuse them. **DO NOT SEPARATE THE C.V. AXLES FROM THE DIFFERENTIAL.** Remove the differential from the truck and set aside. **USE CARE WHEN REMOVING DIFFERENTIAL AS TO NOT DAMAGE THE C.V. Axles and 4WD VACUUM ACTUATOR ASSEMBLY. SEE PHOTO ON NEXT PAGE.**



14. Locate the factory rear crossmember. Mark the crossmember 3 1/2" from outside edge of the cam pocket adjustment hole inward. On the top of the crossmember, locate the bottom hole and measure down 1/4", draw a line straight across the top of the crossmember and connect to the first line that is on the back of the crossmember. On the bottom of the crossmember, draw another line forward from the first line just beside the weld for the control arm pocket. Take care to cut the crossmember straight up and down and to not cut into the control arm pocket itself or cut out the weld. You will use a Sawzall or Die Grinder with a cutoff wheel to make these cuts. Remove the rear crossmember section. Cut and discard. SEE DIAGRAMS AND PHOTOS BELOW AND IN NEXT COLUMN AND ON LAST PAGE

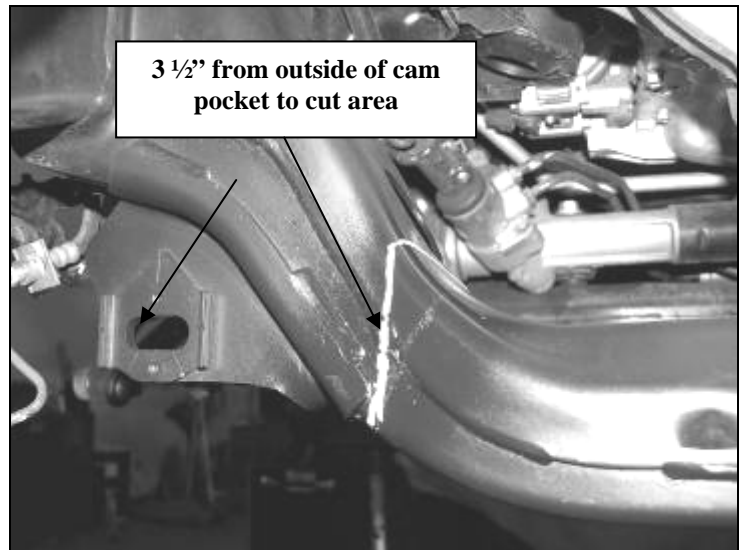
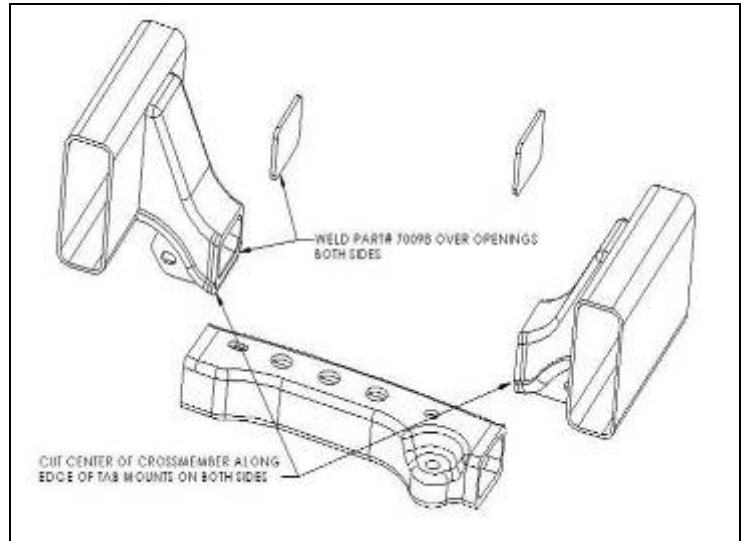
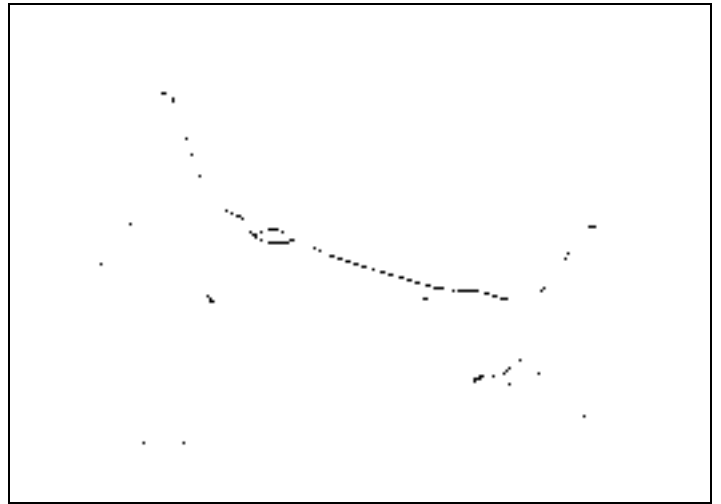

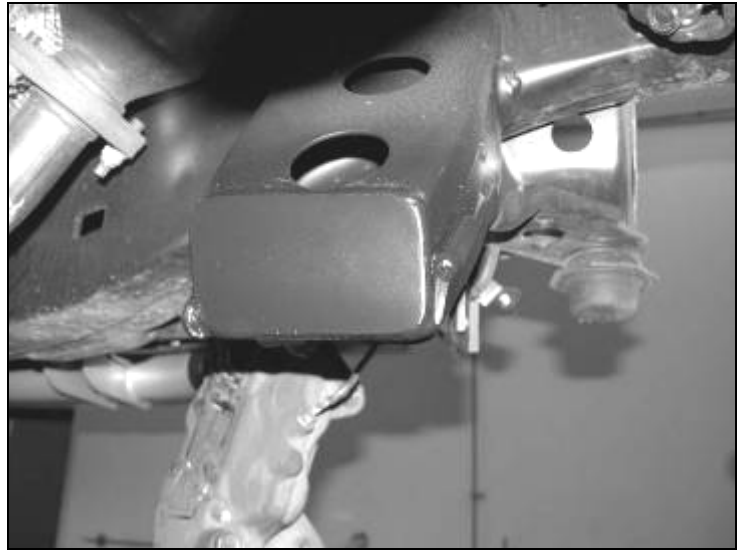

16. Locate FT70073 Weld in plate. You will need to weld in these plates to cover the holes made by cutting out the original cross member. Clean area to bare metal and weld in new plates. Let plate cool and paint with a corrosive resistant paint or under coating. SEE PHOTOS BELOW.

17. Working from the driver's side, mark the front frame section / body mount $5\frac{3}{4}$ " from the face of the frame and the back at 8" from the frame SEE PHOTOS BELOW AND ON NEXT PAGE

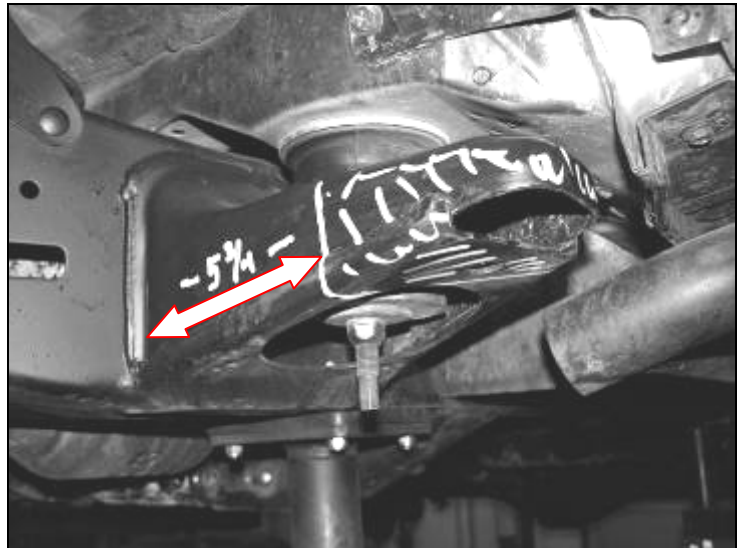

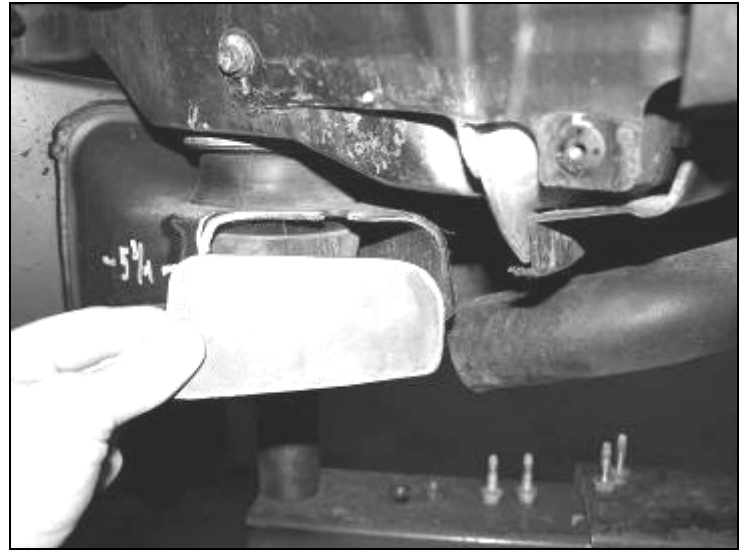
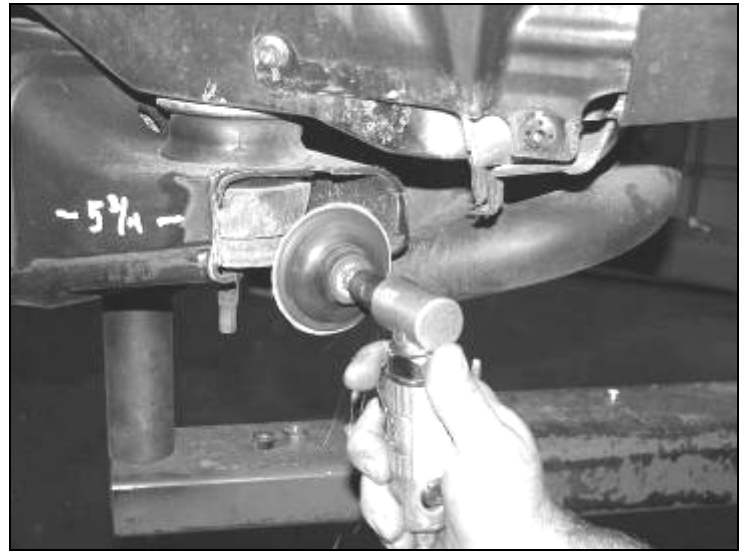
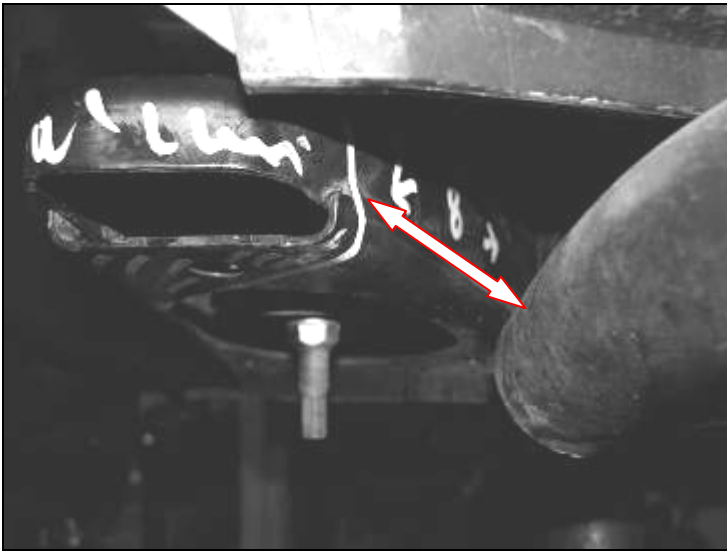

18. Use a sawzall and cut the marked area from the mount. Next, sand and clean the cut area on the mount. Locate FT70094 Weld-in Plate. Check fit the plate against the mount for proper fitment (**it may be necessary to sand the mount for proper fitment of the plate**). Weld the plate in and paint after it has cooled. SEE PHOTOS BELOW AND IN NEXT COLUMN

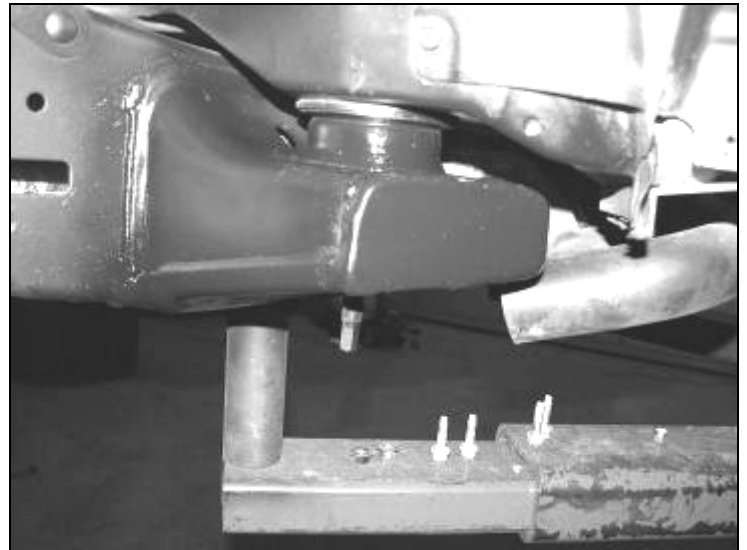

Skip step nineteen for 2wd model trucks.

19. Locate the front differential and remove the factory front mounts. Discard the mounts and save the hardware. Locate FT70053 Driver Diff mount, FT70054 Pass Diff mount, and FT70071 Bushing and Sleeve Kit. Install the four bushings and the two larger I.D. sleeves into the new mounts. Using the

factory hardware and some of the supplied thread-locking compound, mount the new diff mounts to the front differential. Torque the hardware to 75 ft. lbs. SEE PHOTO ON NEXT PAGE.

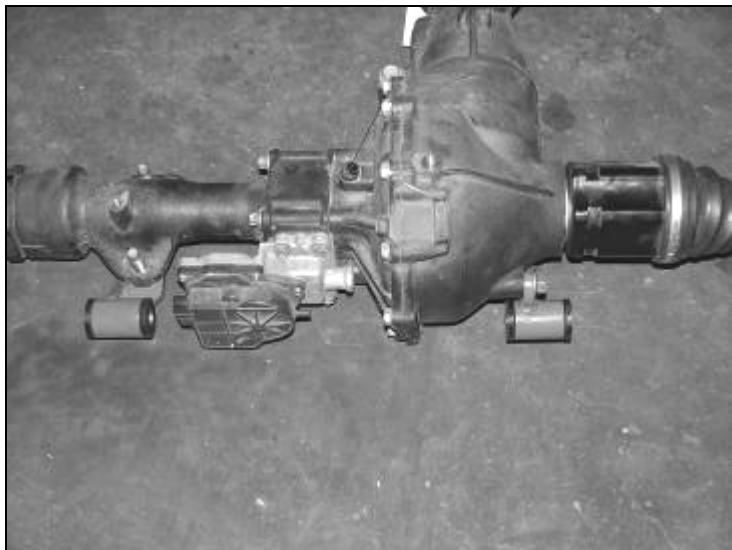

20. Locate the Fabtech front crossmember FT70051, with the supplied $\frac{3}{4}$ " x 4 1/2" bolts, nuts, and washers, attach the crossmember to the factory control arm pockets, leave loose at this time. SEE PHOTO BELOW.



Skip step twenty-one on 2wd model trucks

21. Install the differential up onto the front crossmember with the supplied $\frac{1}{2}$ " x 4" bolts and hardware. Support the differential with a transmission jack. Leave loose at this time. SEE PHOTOS IN NEXT COLUMN.



22. Locate the Fabtech rear crossmember FT70052, with the supplied $\frac{9}{16}$ "x5 bolts, nuts, and washers install the crossmember to the factory control arm pockets. Leave loose at this time. Re-install the factory rear differential nut at this time. SEE PHOTO BELOW.

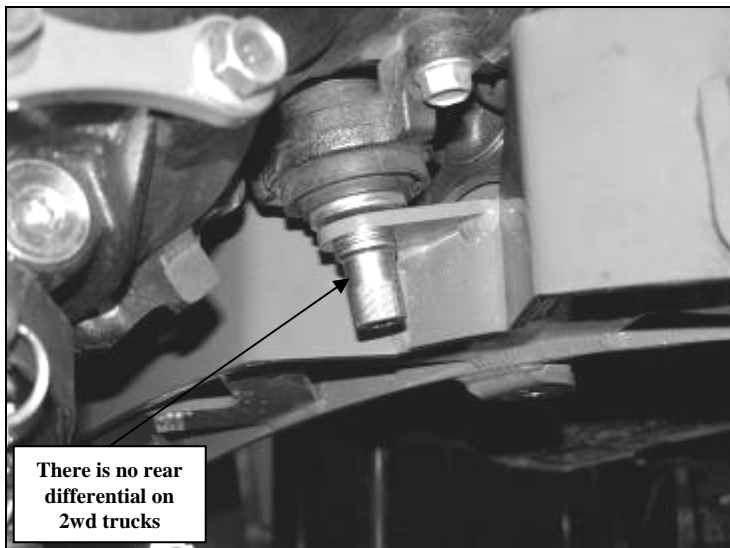

Skip step twenty-three on 2wd model trucks

23. Locate the previously removed factory hardware for the front driveshaft and install with some of the supplied thread-locking compound on the bolts and torque to 50 ft. lbs. Reconnect all electrical, vacuum lines, and breather lines back to the differential.
24. Install the factory lower control arms, using stock alignment bolts and hardware, set cams in the middle of their adjustment range and leave loose. SEE PHOTO BELOW.

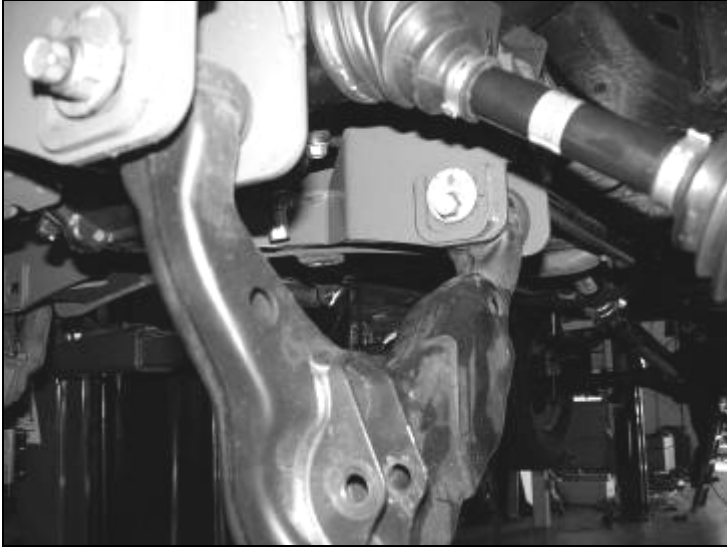

25. Locate FT70058 skid plate. Attach using the supplied hardware (front mount) 5/16"x1 1/4" bolts, nuts, and washers (rear mount) 1/2"x 1 1/2" bolt, nut, and washer. SEE PHOTO BELOW.



FOLLOW STEP TWENTY-SIX FOR THE BASIC KIT INSTALLATION

OR

FOLLOW STEP TWENTY-SEVEN FOR THE PERFORMANCE KIT INSTALLATION

26. Locate the factory shock assembly and hardware. Locate the FT70055 Coil Spacers and supplied 3/8" C-Lock nuts and Washers. Position the spacer onto the top of the shock assembly so that the shortest side of the spacer is angled in towards the shock bucket on the vehicle and attach to the shock with the factory hardware. This must also align with the bottom mounting point of the shock assembly to mount into the lower control arm. Insert the shock assembly up into the bucket and attach with the supplied 3/8" hardware. Leave loose at this time. Place the bottom of the shock into the lower shock mount and attach with the factory hardware. Torque the top 3/8" hardware to 30ft. lbs., factory hardware to 30 ft. lbs., and the lower bolt to 100 ft. Lbs. SEE PHOTO AND DIAGRAM BELOW.



PHOTO SHOWS BASIC SPACER ON FACTORY STRUT

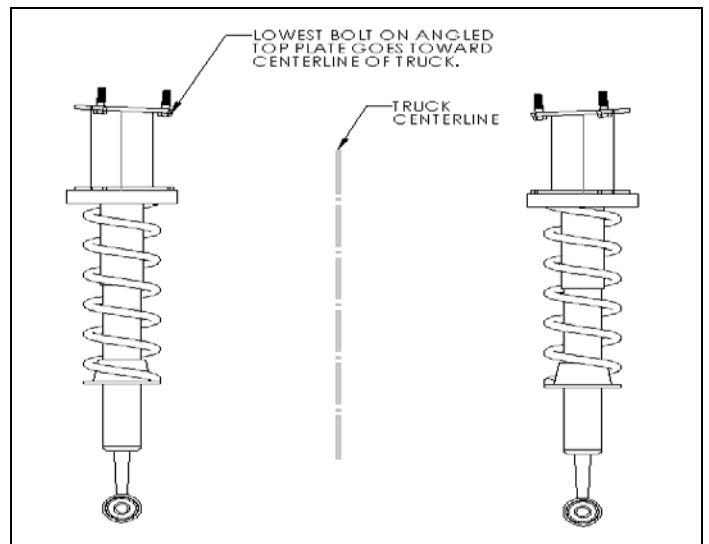

27. Locate and install FTS26008 Coil Over shocks as described in the instructions enclosed with the coilovers. SEE PHOTO ON NEXT PAGE.

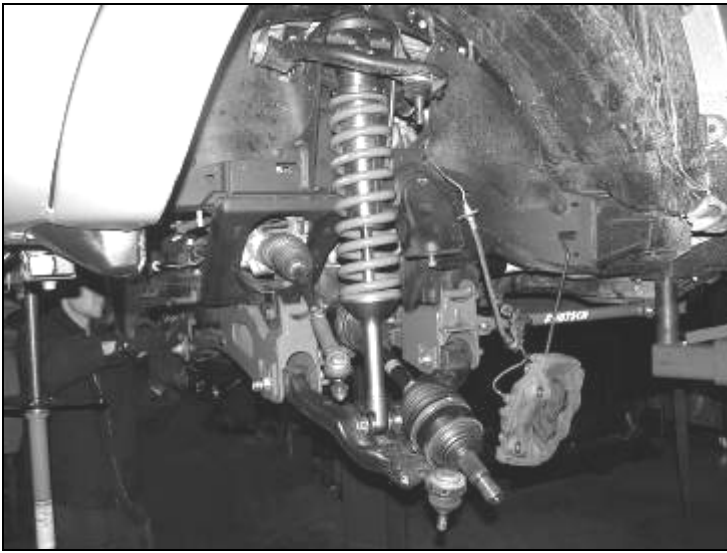

PHOTO SHOWS PERFORMANCE COILOVER

28. Locate the factory steering knuckles and remove the hubs, backing plates, inner seal, and the dust covers. Locate the new Fabtech FTS70044D and FTS70044P steering knuckles. Install the factory hubs, backing plates, factory inner seal, and the dust covers with the factory hardware and supplied thread-locking compound. SEE PHOTOS BELOW



photo shows removal of hub with the backing plate already removed

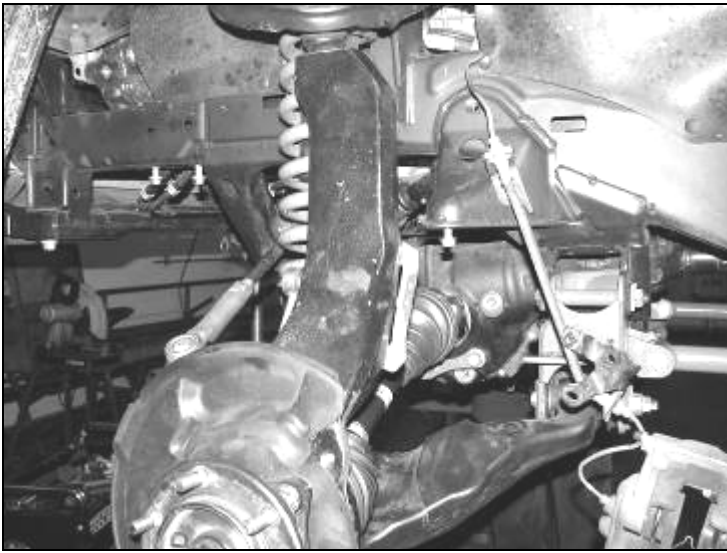

photo above is a completed 4wd knuckle and hub



photos above show removal and installation of the 2wd dust shield

29. Support the lower arm with a floor jack and install the new assembled steering knuckle to the lower ball joint with the factory castle nut and supplied cotter pin. Raise the jack enough to locate the knuckle up into the upper ball joint (pull down on upper arm) and attach with the factory castle nut and supplied new cotter pin. Torque to 35 ft.lbs. SEE PHOTO BELOW



30. Torque factory control arm pocket bolts to 100 ft. lbs., the 3/4" front crossmember bolts to 110 ft. lbs., the 9/16" rear crossmember bolts to 100 ft. lbs., the 1/2" differential mounts to 75 ft. lbs., the 1/2" skid plate bolt to 75 ft. lbs., and the 5/16" skid plate bolts to 20 ft. lbs.

31. Locate the factory brake line tab next to upper control arm. Unbolt the bracket from the frame save hardware and bracket. You will need to carefully pull the hard brake line down 4". Locate FT70061 brake line drop bracket and attach the bracket to the frame with the factory hardware in the upside down J formation. Attach factory bracket to the new bracket using the supplied 5/16" x 1" bolt, nut, and washers. SEE PHOTO BELOW.

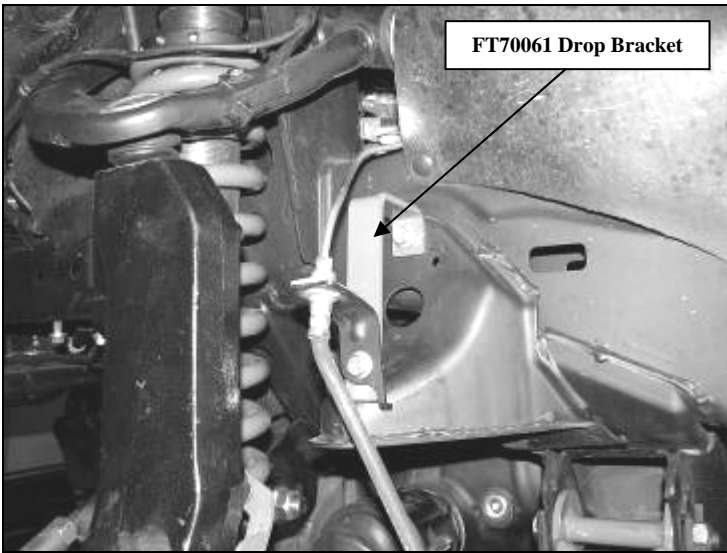

32. Locate FT70063 & FT70064 (drv. / pass.) spindle brake line bracket. Attach to the Fabtech knuckle using the supplied 1/4" x 3/4" bolts, washers, and split washers. Attach the factory bracket to the new brake line bracket using the supplied 1/4" x 3/4" bolt, washer, & split washer. SEE PHOTOS AND DIAGRAM IN THE NEXT COLUMN AND PAGE

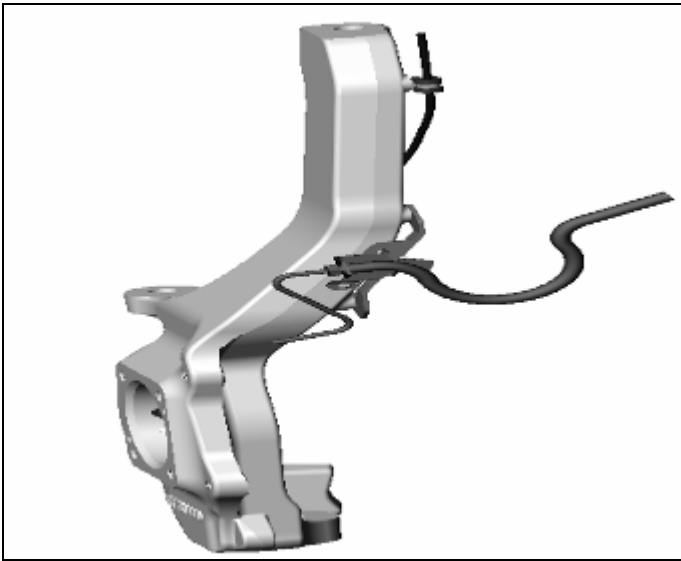

33. Install brake rotors & brake calipers with the factory hardware and thread lock compound. Route the ABS onto backside of the steering knuckle. There should be enough slack just inside the wheel well to pull the line down for the factory sensor to bolt into the new Fabtech steering Knuckle. Using the supplied adel clamps and the 1/4" x 3/4" bolts, washers, & split washers, reinstall the factory ABS Sensor into the Fabtech Knuckle. Now attach the tie rod ends with the factory castle nut and supplied cotter pin. (torque the tie rod ends to 70 ft. lbs.) SEE PHOTO BELOW AND IN NEXT COLUMN

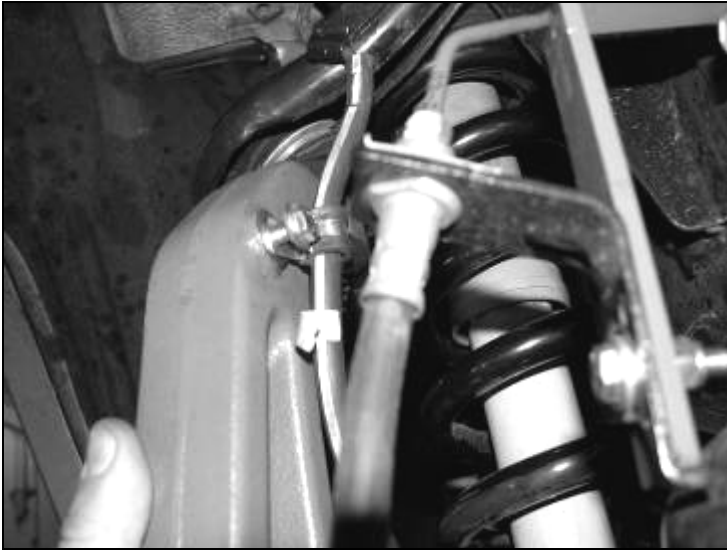

**take note on position of adel clamps
and line must be in the center of the spindle**

34. Remove factory bump stop and discard. Locate FT70056 (drv.) & 70057 (pass.) bumpstop drop bracket. Attach the top of the bracket to the factory bump stop position using the supplied 10mm x 30mm bolt and washer. Attach the two bottom holes of the bracket to the rear Fabtech crossmember, using the supplied 3/8" x 1 1/4" bolts, nuts, & washers. Now locate the supplied FTS88 Bump Stop, attach to the new bump stop bracket using the supplied 3/8" nut, & washer. SEE PHOTOS BELOW AND ON NEXT PAGE

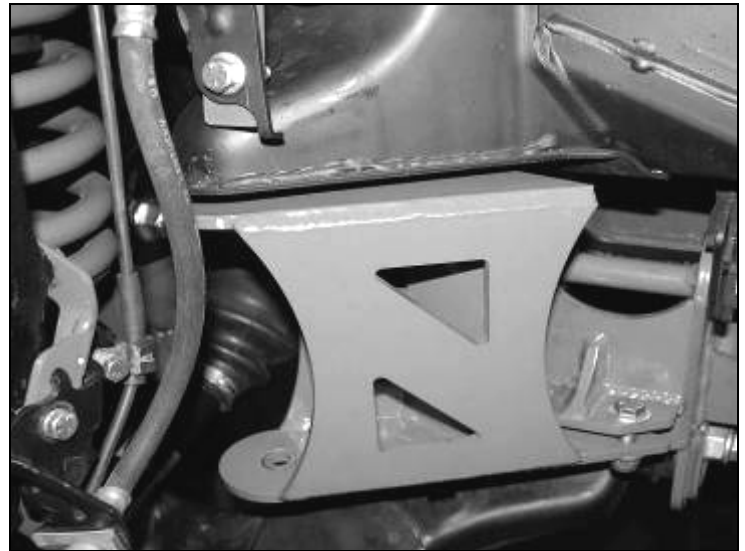

Driver side shown

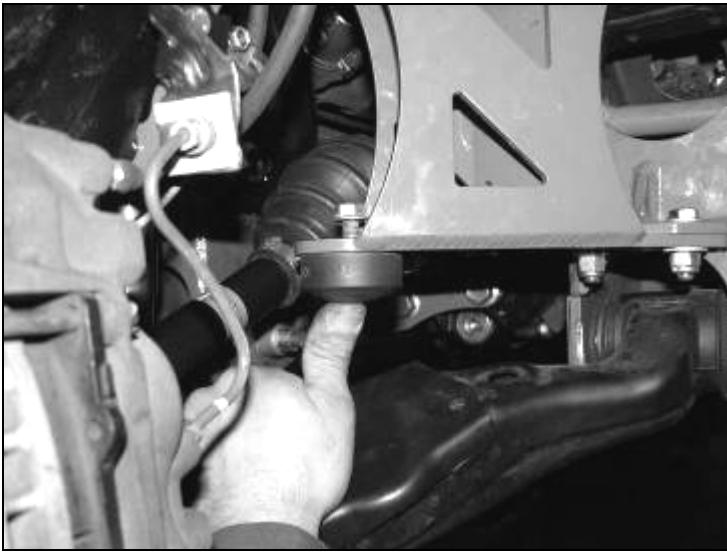

35. Locate FT70100 Driver Sway Bar Drop Bracket, FT70101 Pass. Sway Bar Drop Bracket and the factory sway bar, with hardware. Also locate the supplied 3/8" x 1 1/4" hardware. Position the new drop bracket on the frame so the sway bar will be mounted forward of its factory position and attach with the factory hardware. Use a paint pen or center punch and mark the core support / frame at the front tab of the drop bracket. Use a drill with a 1/2" bit and drill a hole into the support. Locate FT70106 Sway Bar Bracket Nut Tab and the supplied 3/8"x 1 1/4" bolt, flat washer, and split washer. Insert the nut tab into the frame and attach with the 3/8" hardware. SEE PHOTO BELOW

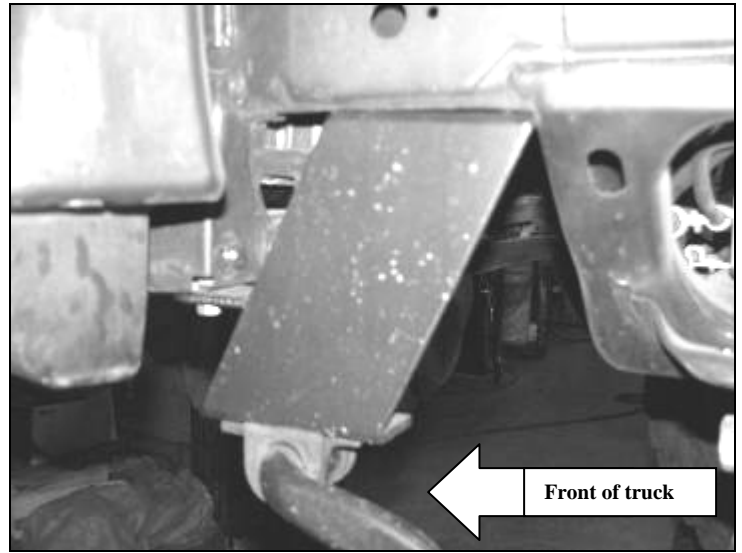

Driver side shown

37. Locate FT70105 Sway Bar End Link, FT95023 1/2" Heims, and supplied 1/2" Jam Nuts. Thread the jam nuts all the way onto the heims. Insert an assembled heim into each end of the end links and leave loose. Locate FT70102 (sway bar hat) and FT70103 (low profile mis-alignment) and the supplied 3/8" x 2 1/4" hardware. Insert the hat and low pro mis-alignment into the heim on one end and attach to the sway bar. Locate FT95020 or FT70159 misalignments and the supplied 3/8" x 3" hardware. Insert the mis-alignments into the upper heim and attach it to the Fabtech steering knuckle. Torque the 3/8" hardware to 30 ft. lbs. SEE DRAWING BELOW AND PHOTOS ON NEXT PAGE



36. Install the sway bar to the new drop brackets with the supplied 3/8" hardware. **(the sway bar will need to be mounted upside down from the factory position).** SEE PHOTO IN NEXT COLUMN

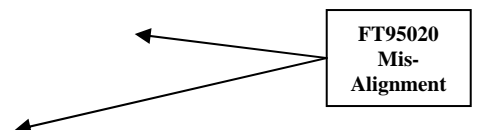
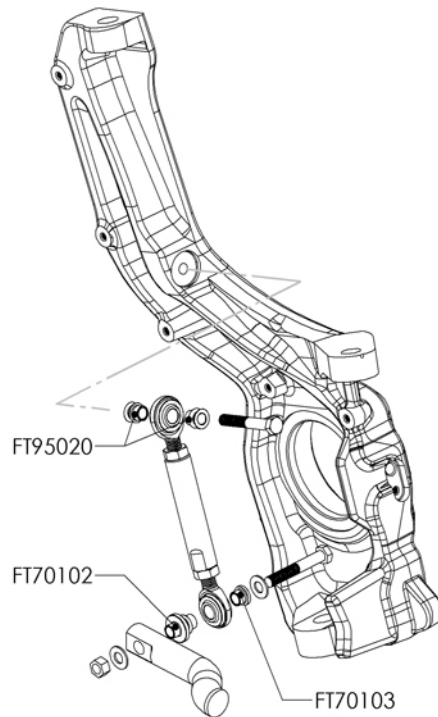

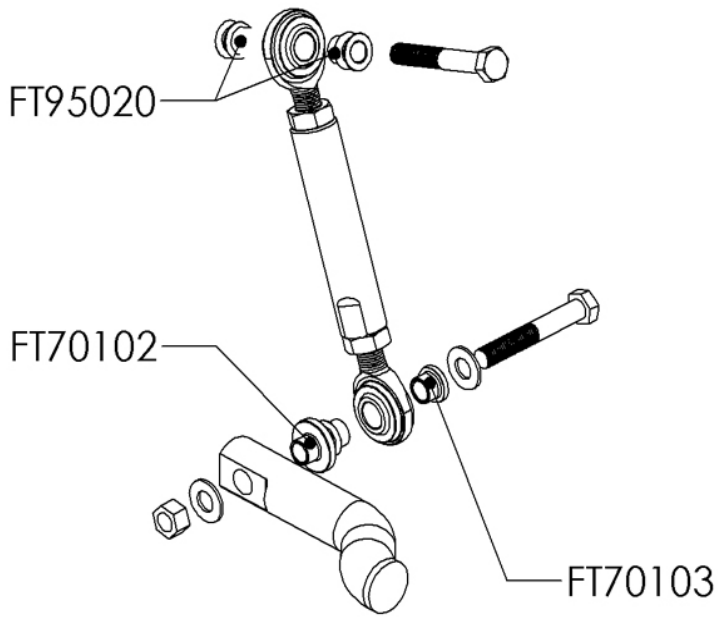

38. Locate the FT70059 Impact Strut mounts, FT133 sleeve, & 1/2" x 3" bolts, nuts, and washers. Install the impact strut mounts to the factory transmission crossmember with the sleeve on top of the bracket. **Note: Some vehicles require drilling out the top hole in the crossmember.** Some vehicles also do not have a "pocket" for the bracket to set inside of the crossmember requiring the use of the provided 1/2" x 3 1/2" bolt instead of the 3" bolt and FT133 Sleeve. Torque to 75ft. lbs. SEE PHOTOS BELOW AND ON NEXT PAGE

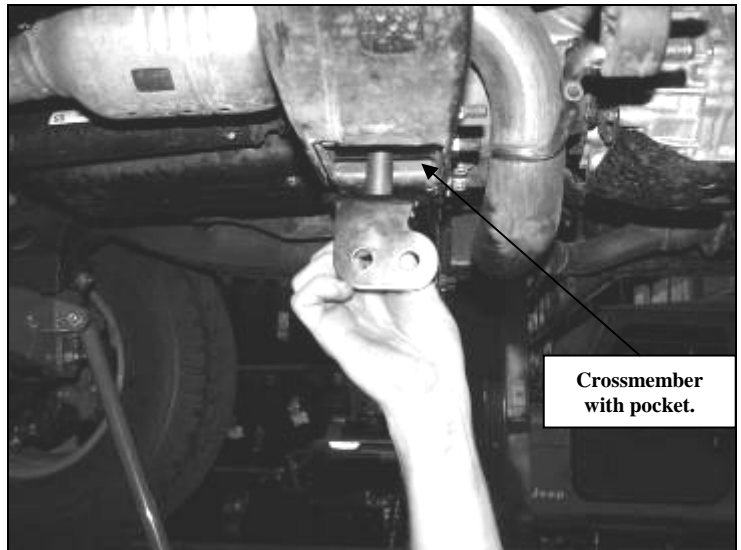
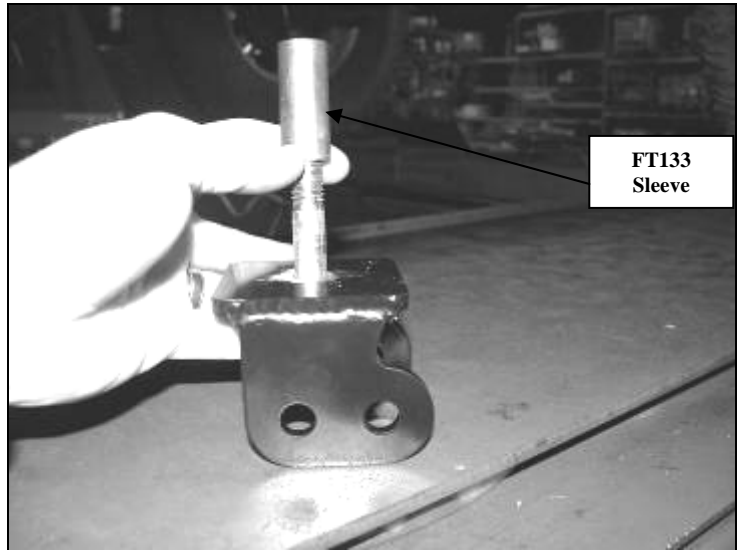
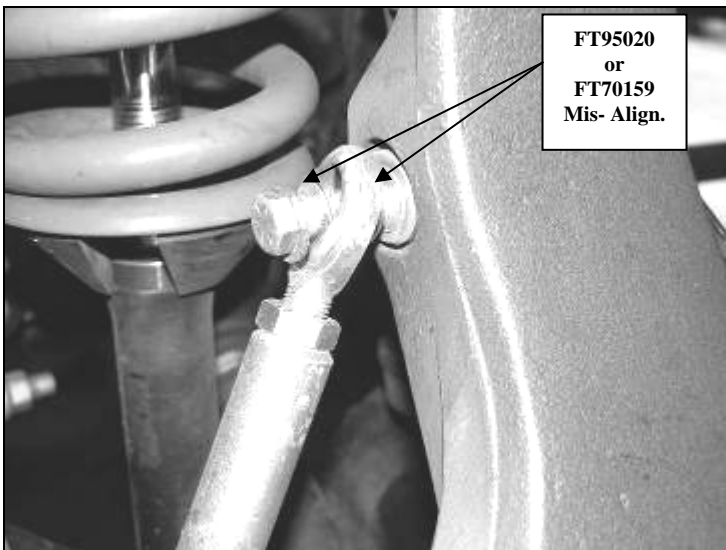
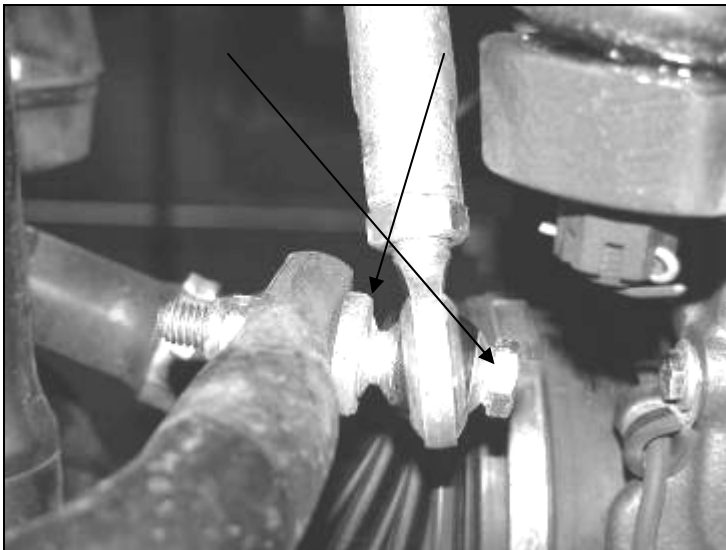

Do not use FT133 sleeve on crossmembers w/out pocket

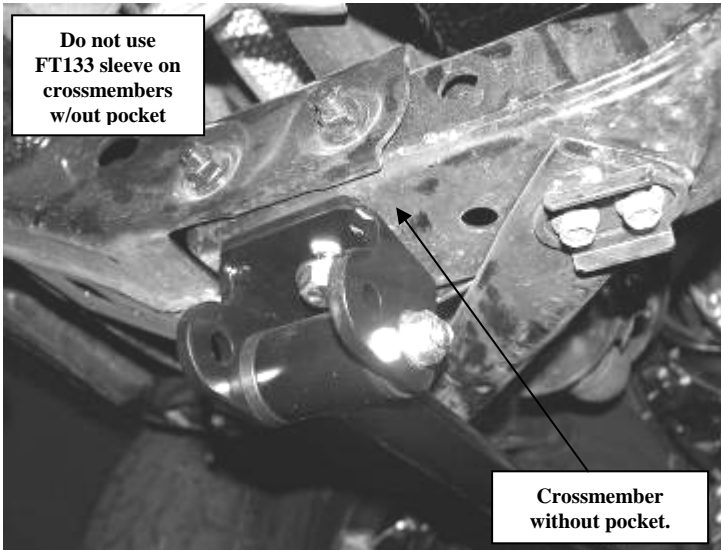

39. Locate FT70011 Impact strut tubes and FT1044 Bushing kit. Install the bushings into the strut tubes. Attach the strut tubes to the rear Fabtech crossmember then to the strut brackets on the transmission crossmember with the supplied 7/16" x 3 1/2" bolts and hardware. Torque to 50 ft. lbs. SEE PHOTO BELOW.

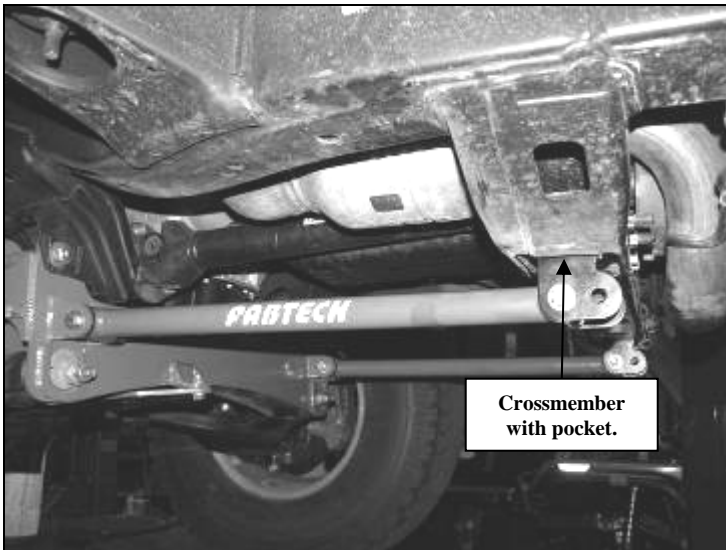

40. Re-install the wheels and tires and torque to the wheel manufactures specs. Turn wheels left to right to check for proper clearance between brake lines / ABS Lines to tires and wheels with vehicle hanging and on the ground. Reroute lines as required for clearance.

Rear Suspension Instructions:

41. Jack up the rear end of the vehicle and support the frame rails with jack stands. Supporting the rear differential remove and discard the rear shocks, save hardware.
42. Disconnect the brake line brackets on the lower link arms, upper link arm mount on the axle, the mount at the top of the differential housing, and the frame on the driver's side. Remove the ABS line from the frame on the passenger side, save all hardware. SEE PHOTOS BELOW AND ON NEXT PAGE

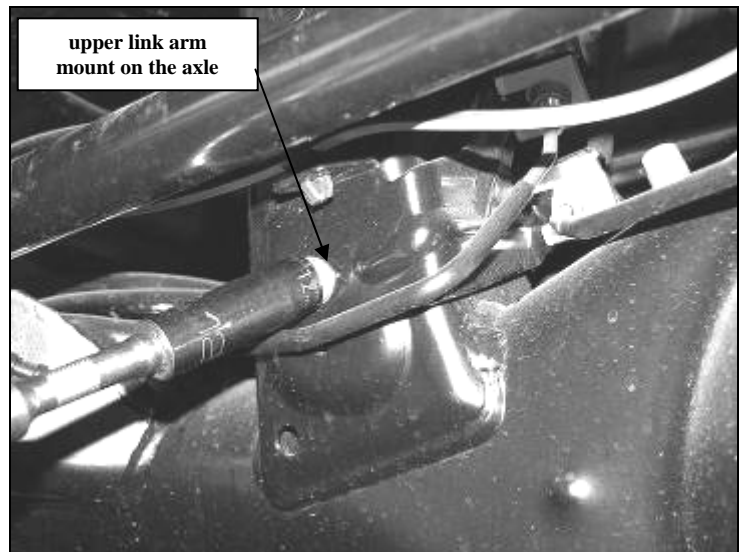
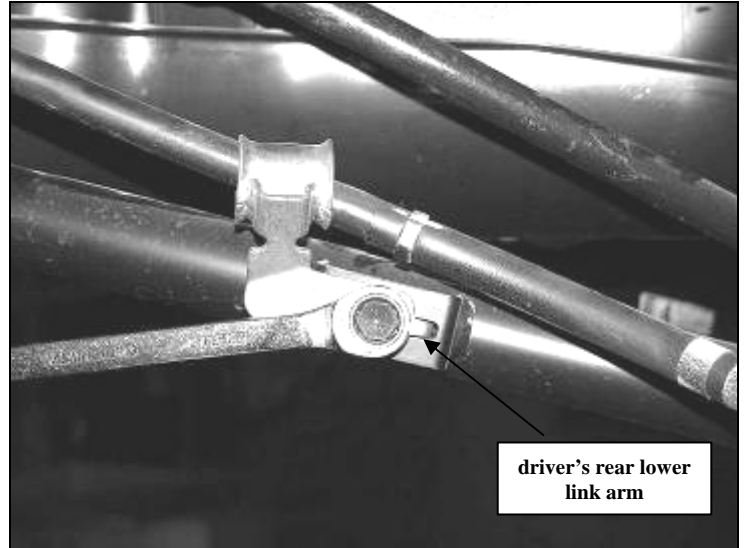

View of driver side rear axle

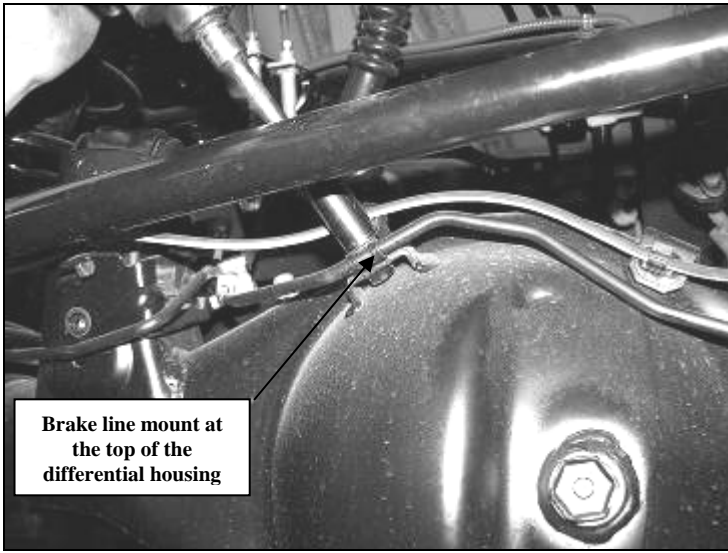

Brake line mount at the top of the differential housing

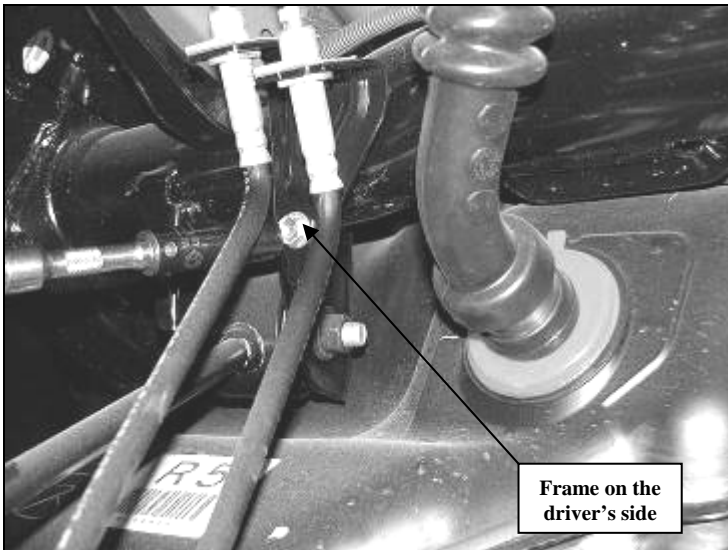

Frame on the driver's side

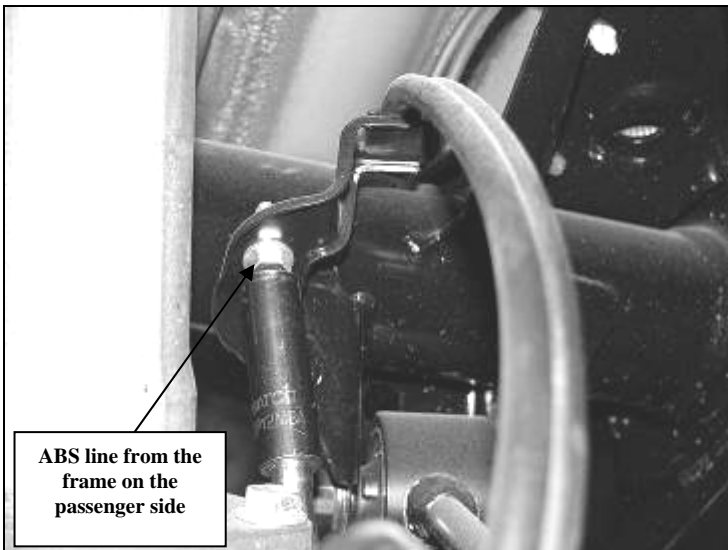

ABS line from the frame on the passenger side

43. Support the axle with a floor jack and remove the shocks and the sway bar endlinks. Save the shock hardware and discard the rest.
44. Remove and save the trac bar, coil springs, and the bumpstops on the frame.

45. Locate FT70084 (upper) and FT70085 (lower) Link Arms and FT70092 Bushing kit. Using an arbor press, press the bushing and sleeves (use supplied bushing lube) into each **end of the links** and **install the supplied zerk fittings**. SEE PHOTOS BELOW

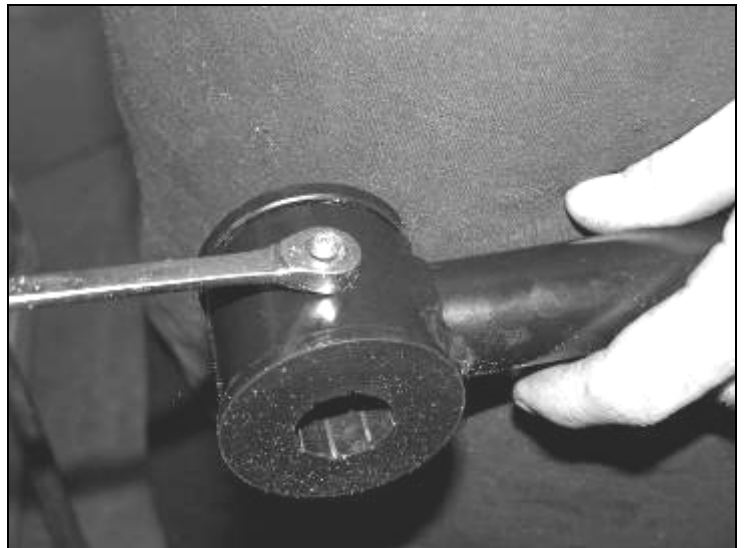
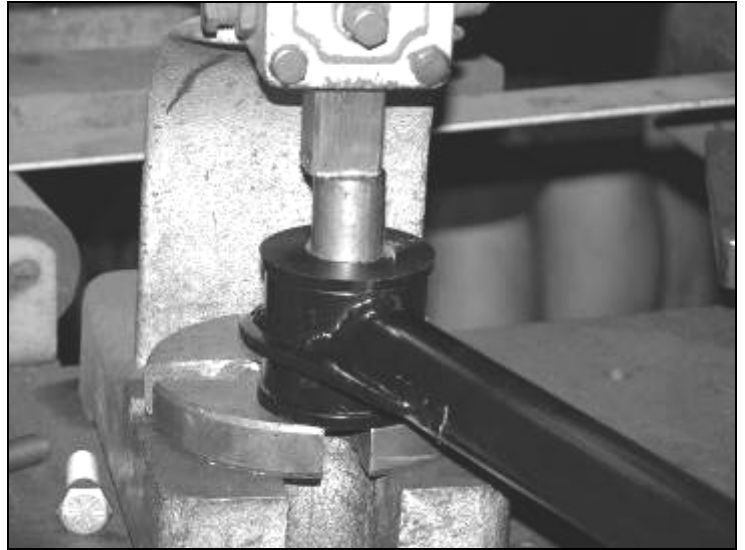

46. Remove the driver lower link and install an assembled Fabtech link with the gussets facing down using the stock hardware. Repeat on the passenger lower link. SEE PHOTOS ON NEXT PAGE



Gussets facing down

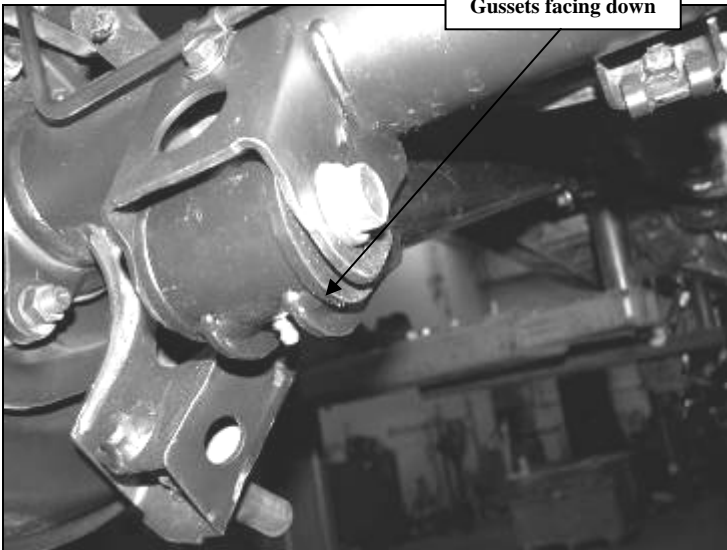

47. Remove the driver upper link and install an assembled Fabtech link with the gusset facing upward in the frame pocket and down at the axle mount with the stock hardware. Repeat on the passenger upper link. SEE PHOTO BELOW

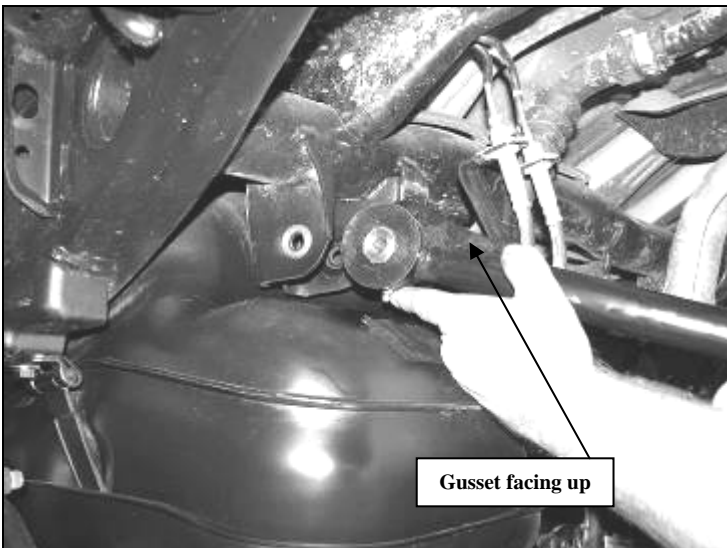

Gusset facing up

48. Working from the driver side, locate FT70086 Rear Coil Spacers and the supplied 3/8" & 8mm hardware. Position the coil spacer up into the coil bucket on the frame and attach to the factory bumpstop mount with the 8mm hardware (only tighten enough to hold the spacer in position). Mark the three holes in the spacer to the coil bucket and remove the spacer. SEE PHOTOS BELOW

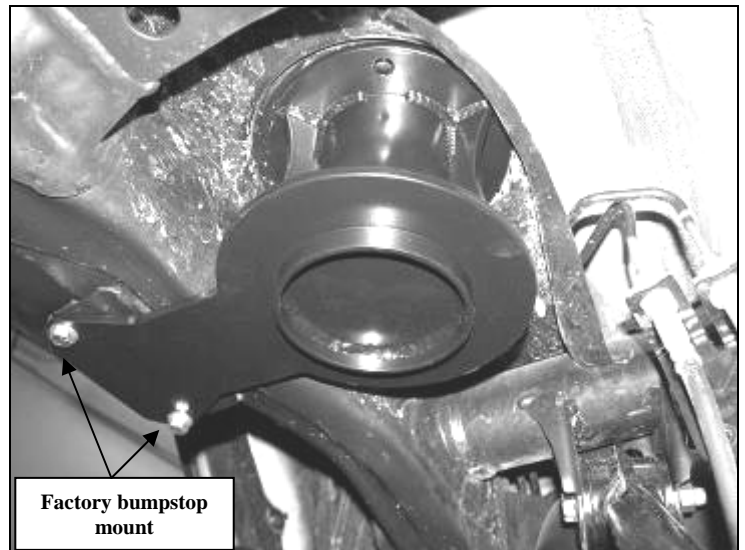

Factory bumpstop mount

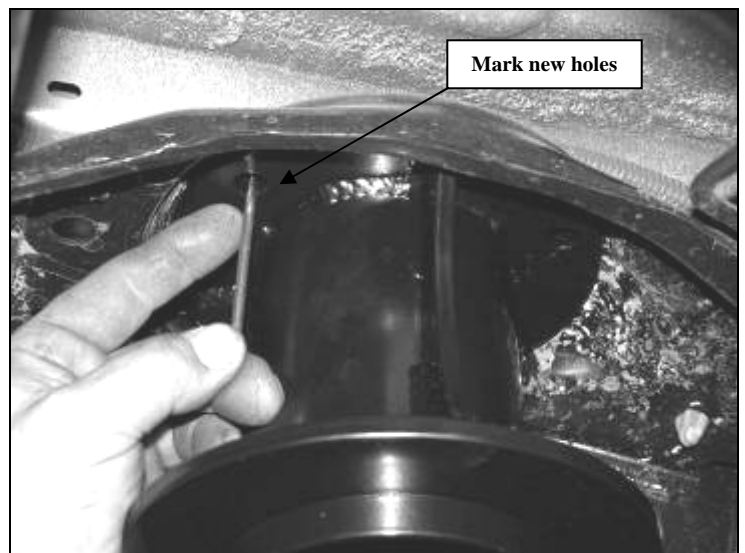

Mark new holes

49. Use a drill with a 3/8" bit and drill out the three holes in the bucket. Install the spacer with the 3/8" hardware. Leave loose. Locate FT70093 Rear Bumpstop Bracket, supplied 5/16" hardware, and the factory bumpstop. Mount the factory bumpstop to the new bracket with the 5/16" hardware. Position the new mount to the bottom of the coil spacer and attach both to the factory bumpstop mount with the 8mm hardware. Torque the 3/8" hardware to 30 lbs. and the 5/16" & 8mm hardware to 20 lbs. SEE PHOTOS ON NEXT PAGE



**Remove spacer and
drill new holes**

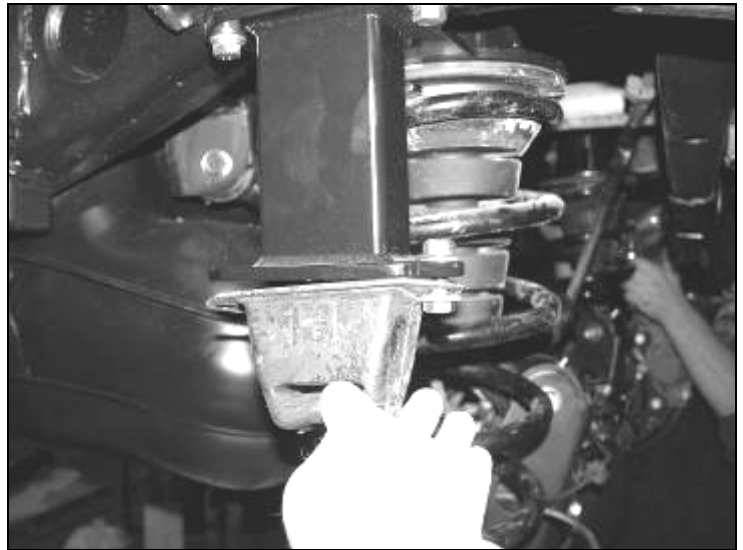

Coil shown for bumpstop install only



50. Repeat steps forty-six & forty-seven on the passenger side.

51. Locate the factory rear coils and bumpstop. Use a coil spring compressor and install the coils (with the bumpstops inside) onto the new spacer and the axle mount. The bottom end of the coil spring must set against the stop on the axle mount for proper fitment and ride height. **SEE PHOTOS BELOW**

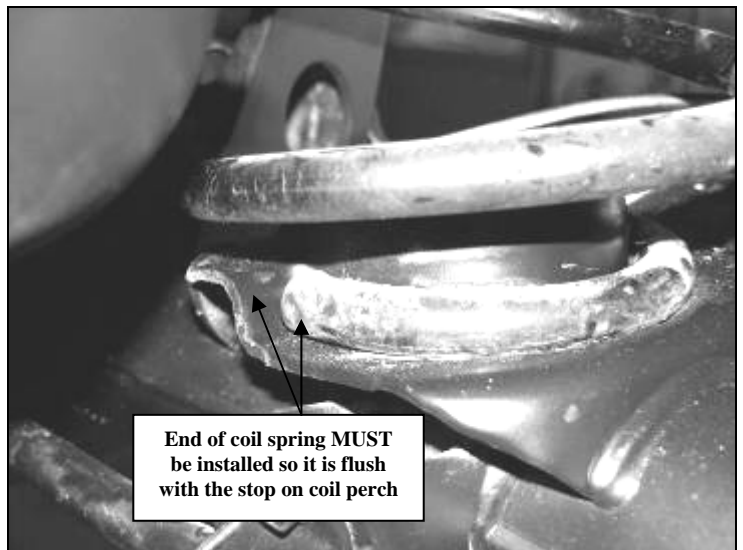

**End of coil spring MUST
be installed so it is flush
with the stop on coil perch**

52. Locate FT70088 Trac Bar Bracket and install into the factory trac bar mount on the frame with the supplied 9/16" hardware. Rotate the new bracket so that the support tube mount makes contact with the rear crossmember. Using a drill with a 1/2" bit, drill the new hole into the crossmember. Locate FT70096 Trac Bar Nut Tab and insert into the bottom of the crossmember just behind the new bracket and attach with the supplied 1/2" x 1 1/2" bolt, flat washer, and split washer. Torque the 1/2" hardware to 75 lbs and the 9/16" to 95 lbs. Locate and install the factory trac bar and hardware. Torque to 75 lbs. SEE PHOTOS BELOW AND IN NEXT COLUMN

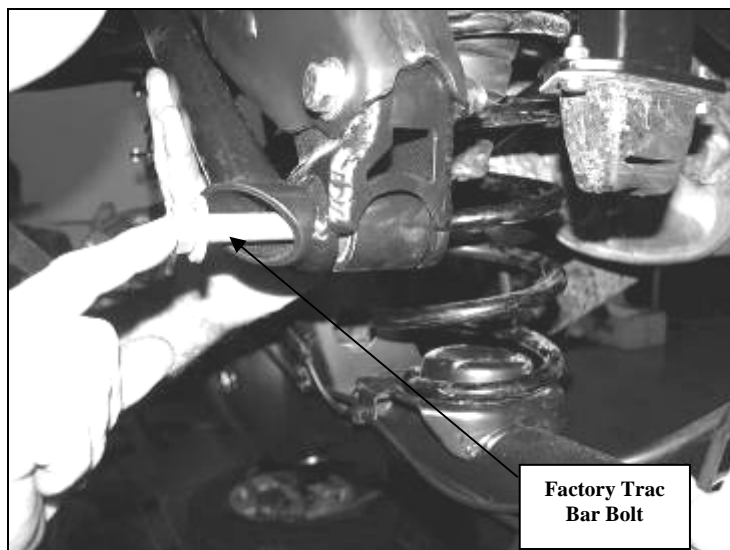
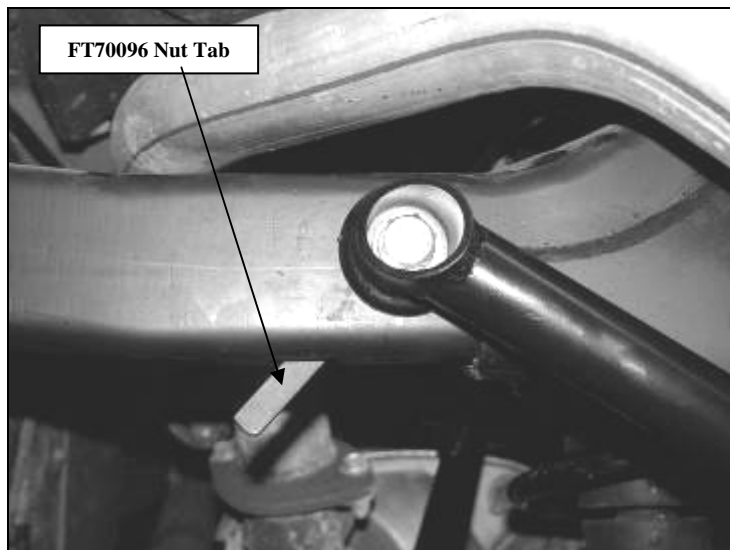

53. Locate FT70089 Brake Line Bracket and the supplied 5/16 x 3/4" hardware. Position the new bracket onto the factory brake line bracket on the driver's side on the crossmember and attach with the factory hardware. Use the 5/16 to attach the brake line bracket to the new Fabtech bracket. Torque the hardware to 15 lbs. SEE PHOTO BELOW AND ON NEXT PAGE

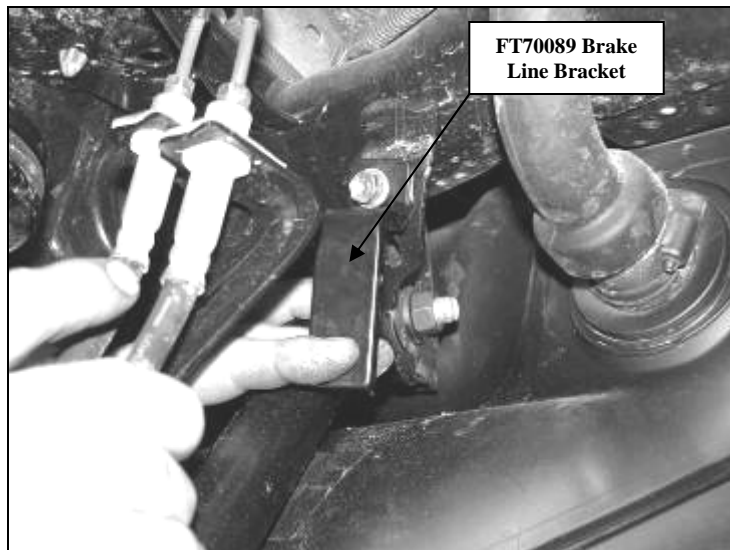

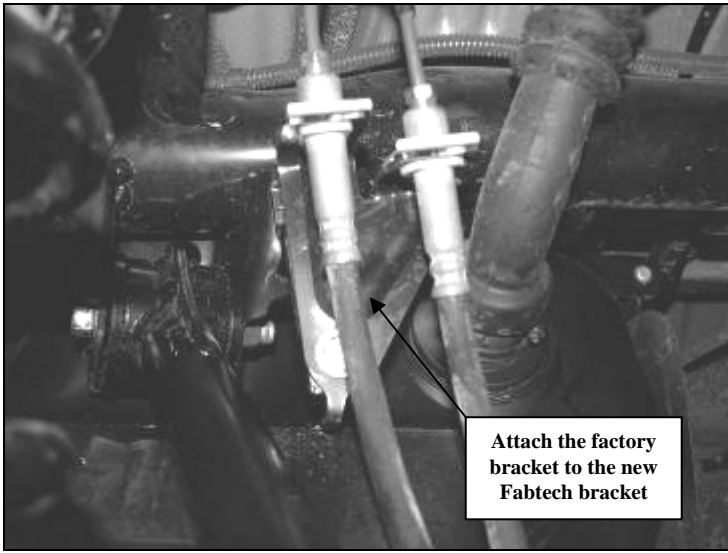

Attach the factory bracket to the new Fabtech bracket

54. Re-connect the ABS sensor to the harness. Locate the ABS bracket on the crossmember and carefully bend the bracket down (**do not over bend, it could brake the bracket**) just enough so it lines up with the clamp on the ABS lines. Check to ensure that there will be enough slack for the cables during suspension cycling. Attach the ABS clamp to the bracket with the factory hardware. SEE PHOTOS BELOW AND IN NEXT COLUMN

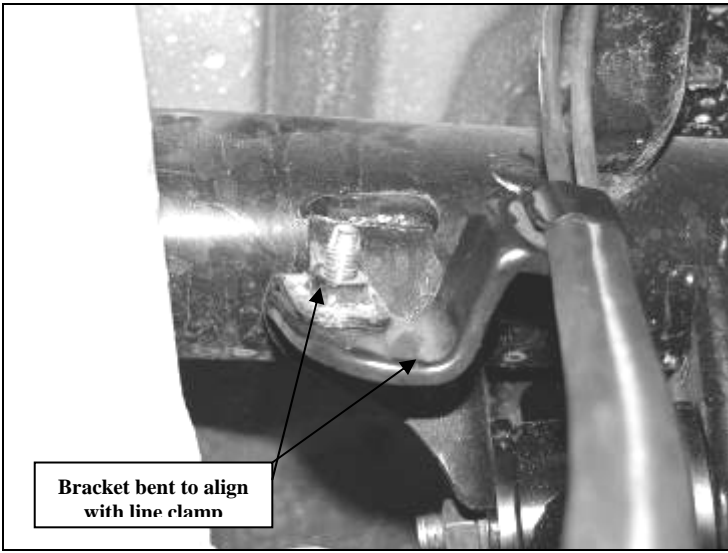

Bracket bent to align with line clamp

55. Attach the factory e-brake cable bracket with the supplied 5/16" hardware to the mounts on the new lower links. Torque to 15 lbs. SEE PHOTO BELOW

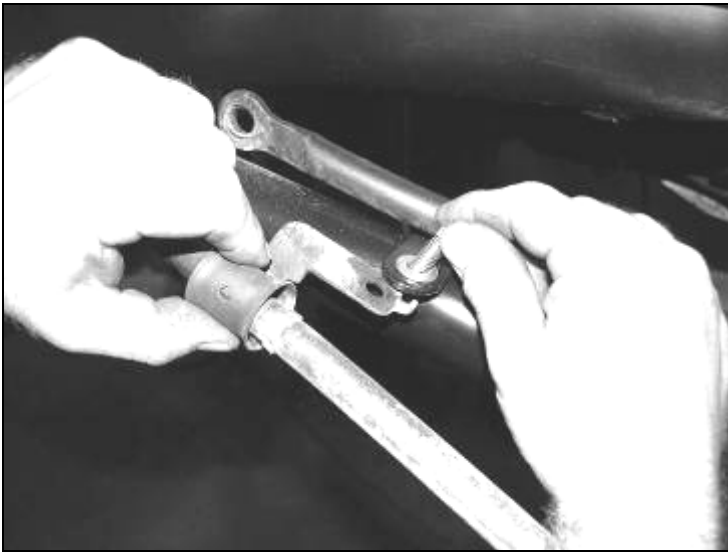
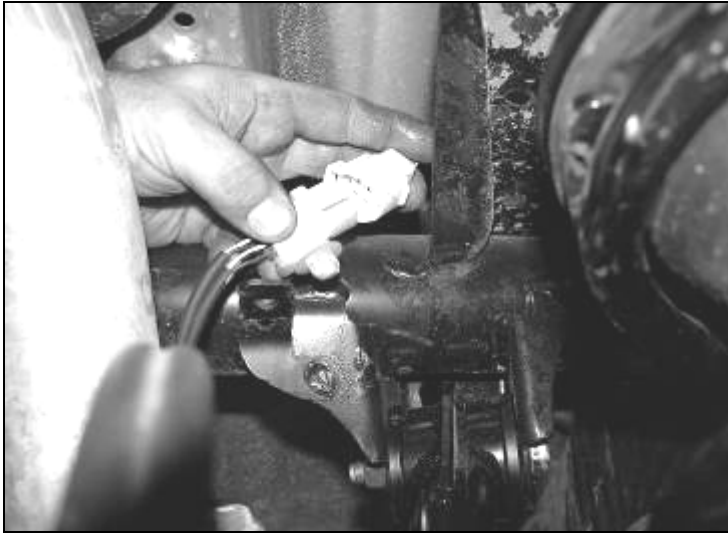

56. Locate FT70090 Sway Bar End Links and FT50116 Bushing Kit. Using an arbor press, press an hourglass bushing and sleeve into the barrel end of the links. Install a cup washer and flat bushing on the stem of the end link and install into the mount on the frame. Place the other bushing and cup washer and supplied 3/8" fine thread nut on the top of the link and leave loose. SEE PHOTO ON NEXT PAGE

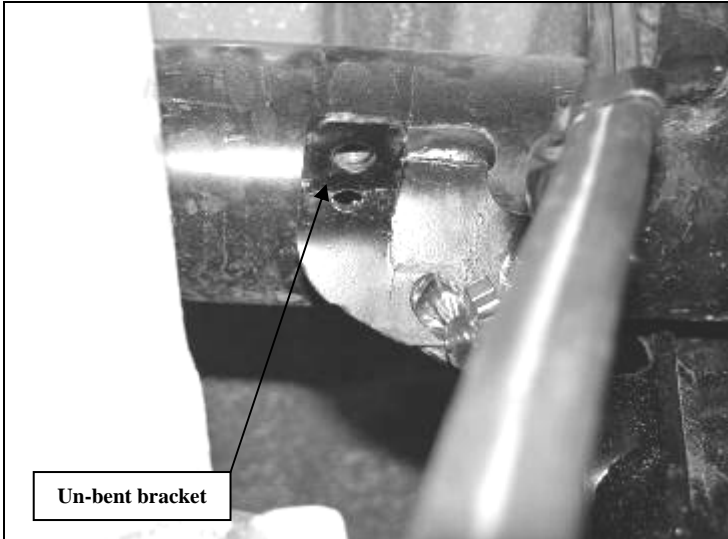

Un-bent bracket

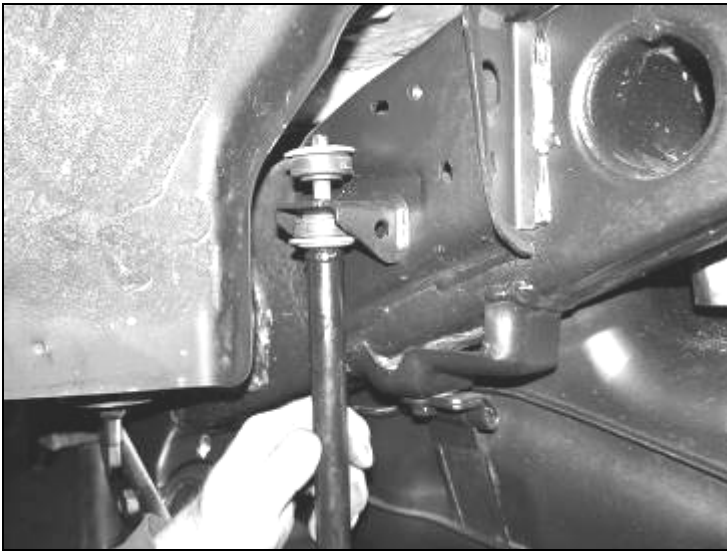

57. Locate the supplied 12mm bolt, nut, and large washers. Place a washer onto the bolt and insert into the sway bar from the inside of the bar. Follow with another large washer. Mount the bar to link and follow with another large washer and the C-lock nut. Tighten the lower bolt first and then the upper nut. Only tighten enough to get the bushings to bulge. SEE PHOTO BELOW

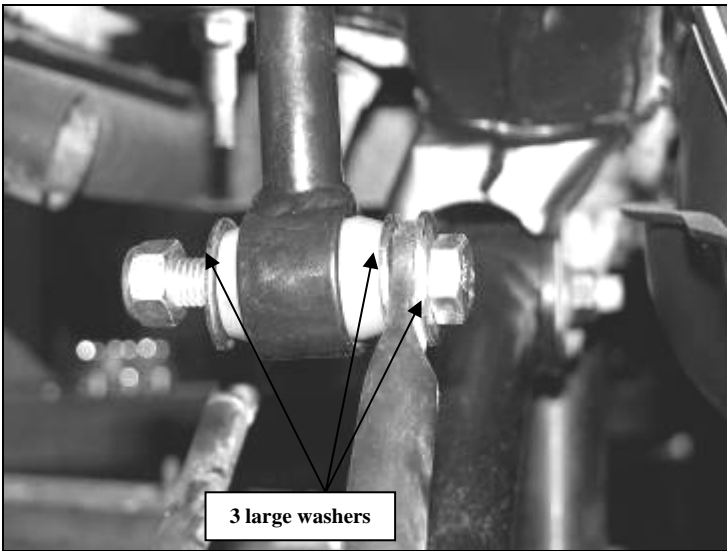

58. Install the new Fabtech shocks FTS7237 (not included with the kit) and FT83239 Shock Spacer with the factory hardware and supplied shock sleeve. Install the spacer onto the lower shock mount and follow with the shock and factory hardware. Torque upper and lower bolts to 53lbs. SEE PHOTO BELOW

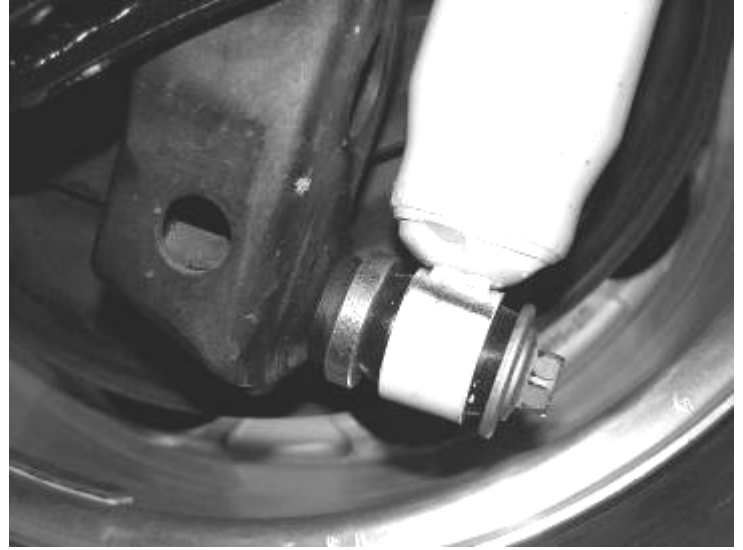

59. Recheck all bolts for proper torque. Recheck brake hoses and lines for proper clearances.
60. Check the fluid in the front differential. Fill if needed with factory specification differential oil to factory capacity.
61. Install tires and wheels and torque lug nuts to wheel manufacturer's specifications. Turn front tires left to right and check for appropriate tire clearance. Note- some vehicles may require trimming of the front plastic bumper valance for tire clearance.
62. Check front-end alignment and set to factory specifications. Re-adjust headlights.

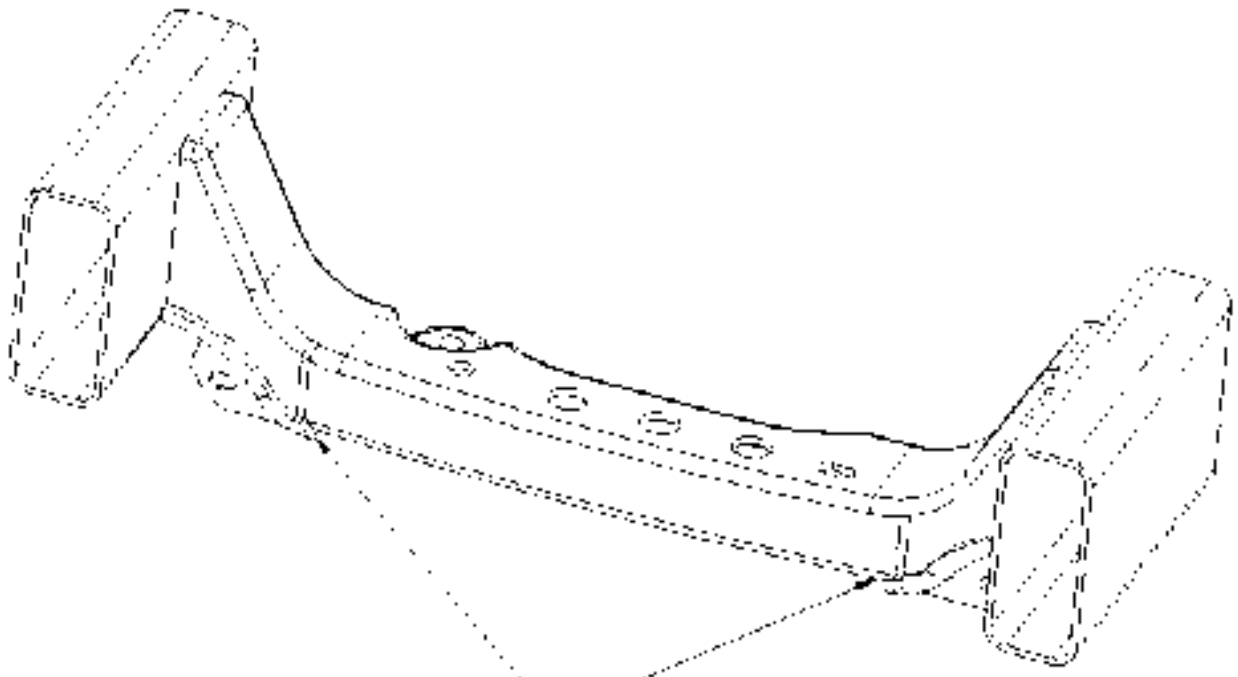

CUT CENTER OF CROSSMEMBER ALONG
EDGE OF TAB MOUNTS ON BOTH SIDES

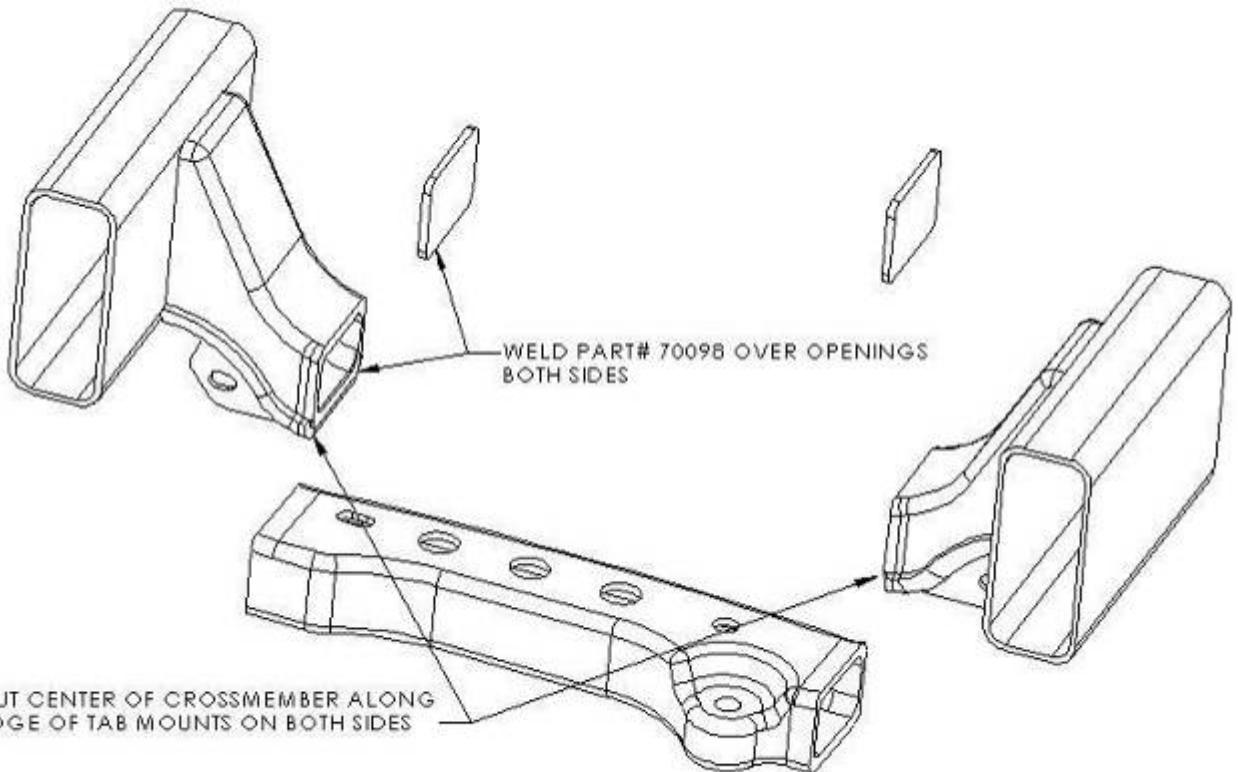

WELD PART# 7009B OVER OPENINGS
BOTH SIDES

CUT CENTER OF CROSSMEMBER ALONG
EDGE OF TAB MOUNTS ON BOTH SIDES

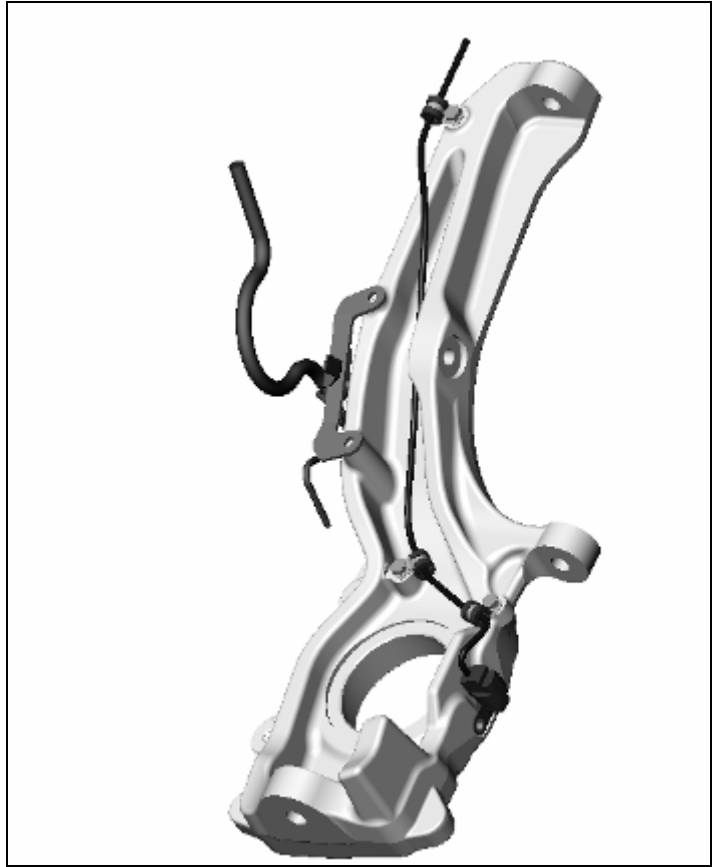
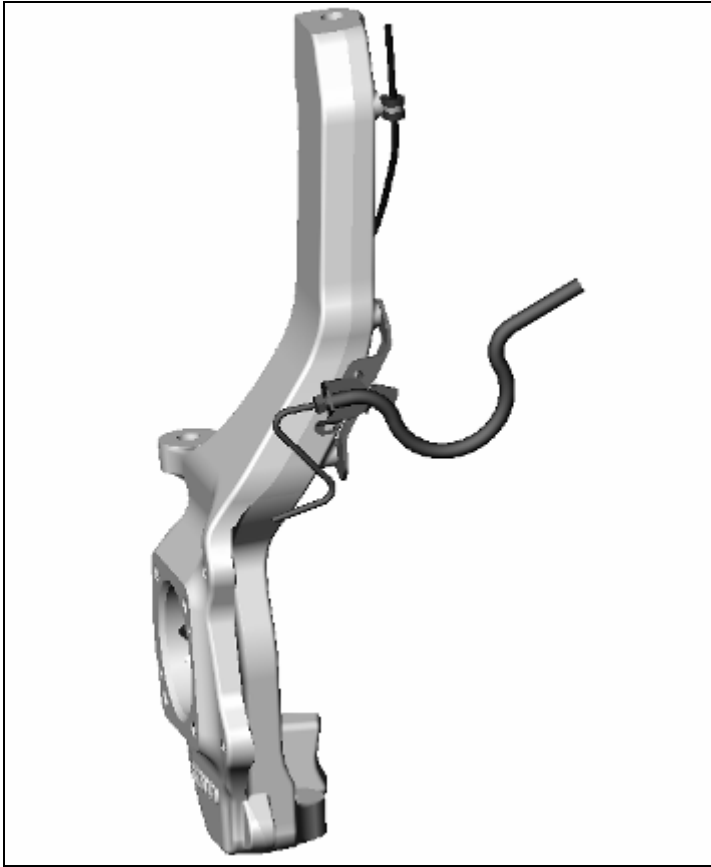
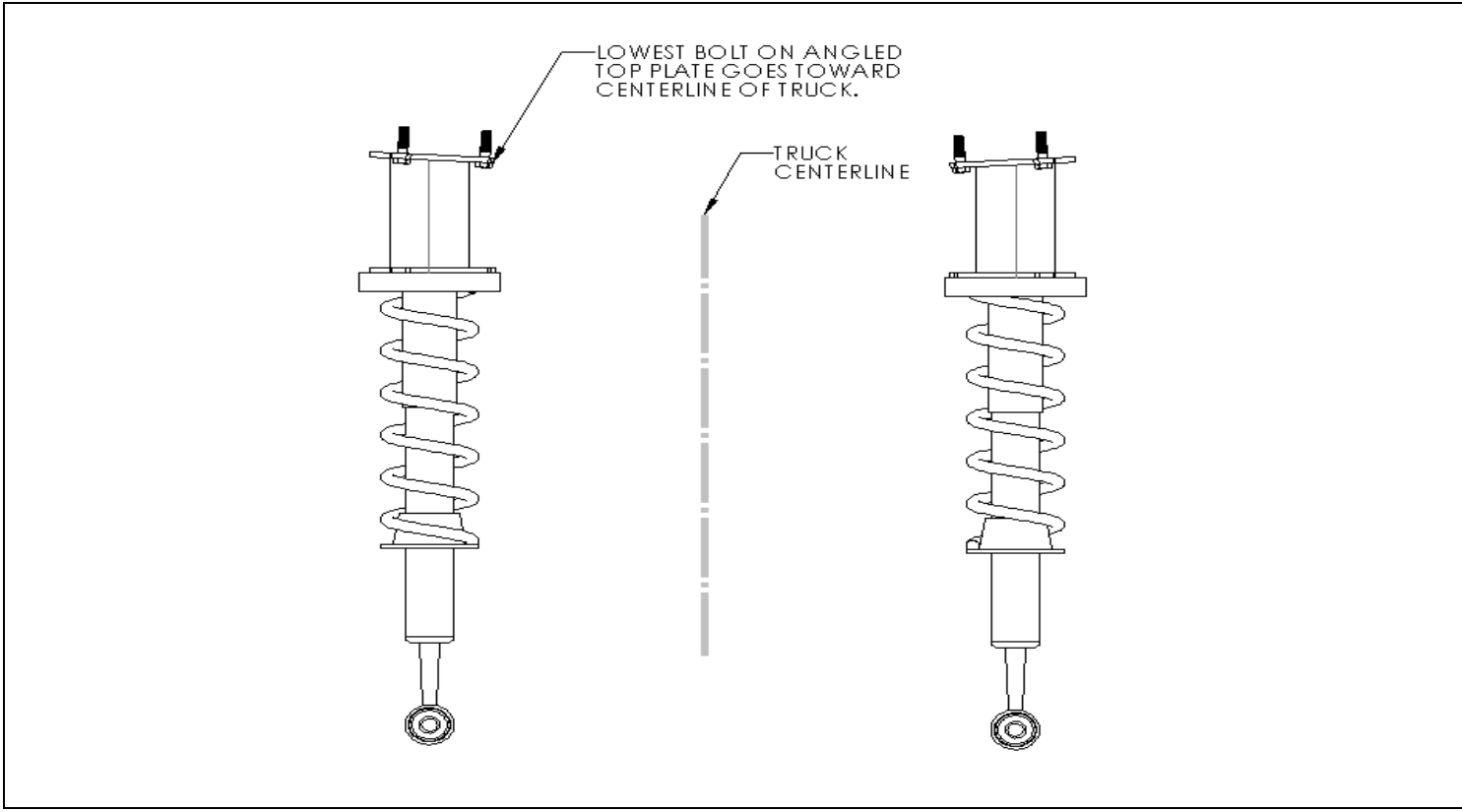

RETORQUE ALL NUTS, BOLTS AND LUGS AFTER 50 MILES AND PERIODICALLY THEREAFTER

For technical assistance call: 909-597-7800

Product Warranty and Warnings-

Fabtech provides a Limited Lifetime Warranty to the original retail purchaser who owns the vehicle, on which the product was originally installed, for defects in workmanship and materials.

The Limited Lifetime Warranty excludes the following Fabtech items; bushings, bump stops, ball joints, tie rod ends, limiting straps, cross shafts, heim joints. These parts are subject to wear and are not considered defective when worn. They are warranted for 60 days from the date of purchase for defects in workmanship.

Take apart shocks are considered a serviceable shock with a one-year warranty on leakage only. Service seal kits are available separately for future maintenance. All other shocks are covered under our Limited Lifetime Warranty.

Fabtech does not warrant any product for finish, alterations, modifications and/or installation contrary to Fabtech's instructions. Alterations to the finish of the parts including but not limited to painting, powdercoating, plating and/or welding will void all warranties. Some finish damage may occur to parts during shipping which is considered normal and is not covered under warranty.

Fabtech products are not designed nor intended to be installed on vehicles used in race applications or for racing purposes or for similar activities. (A "RACE" is defined as any contest between two or more vehicles, or any contest of one or more vehicle against the clock, whether or not such contest is for a prize). This warranty does not include coverage for police or taxi vehicles, race vehicles, or vehicles used for government or commercial purposes. Also excluded from this warranty are sales outside of the United States of America.

Installation of most suspension products will raise the center of gravity of the vehicle and will cause the vehicle to handle differently than stock. It may increase the vehicle's susceptibility to a rollover, on road and off road, at all speeds. Extreme care should be taken to operate the vehicle safely at all times to prevent rollover or loss of control resulting in serious injury or death. Fabtech front end Desert Guards may impair the deployment or operation of vehicles equipped with supplemental restraining systems/air bag systems and should not be installed if the vehicle is equipped as so.

Fabtech makes every effort to ensure suspension product compatibility with all vehicles listed in the catalog, but due to unknown auto manufacturer's production changes and/or inconsistencies by the auto manufacturer, Fabtech cannot be responsible for 100% compatibility, including the fitment of tire and wheel sizes listed. The Tire and Wheel sizes listed in Fabtech's catalog are only a guideline for street driving with noted fender trimming. Fabtech is not responsible for damages to the vehicle's body or tires.

Fabtech's obligation under this warranty is limited to the repair or replacement, at Fabtech option, of the defective product only. All costs of removal, installation or re-installation, freight charges, incidental or consequential damages are expressly excluded from this warranty. Fabtech is not responsible for damages and/or warranty of other vehicle parts related or non related to the installed Fabtech product. This warranty is expressly in lieu of all other warranties expressed or implied. This warranty shall not apply to any product that has been subject to accident, negligence, alteration, abuse or misuse as determined by Fabtech.

Fabtech suspension components must be installed as a complete system including shocks as shown in our current catalog. All warranties will become void if Fabtech parts are combined and/or substituted with other aftermarket suspension products. Combination and/or substitution of other aftermarket suspension parts may cause premature wear and/or product failure resulting in an accident causing injury or death. Fabtech does not warrant products not manufactured by Fabtech.

Installation of Fabtech product may void the vehicles factory warranty; it is the consumer's responsibility to check with their local vehicle's dealer for warranty disposition before the installation of the product.

It is the responsibility of the distributor and/or the retailer to review all warranties and warnings of Fabtech products with the consumer prior to purchase.

Fabtech reserves the right to supercede, discontinue, change the design, finish, part number and, or application of parts when deemed necessary without written notice. Fabtech is not responsible for misprints or typographical errors within the catalog or price sheet.