



INSTALLATION INSTRUCTIONS

2016-2021 TOYOTA TACOMA 6" KIT

FT26065i

Fabtech Motorsports | 4331 Eucalyptus Ave. Chino, CA 91710

Tech Line: 909-597-7800 | **Fax:** 909-597-7185 | **Web:** www.fabtechmotorsports.com

- PARTS LIST -

K7047 6" BASIC SYSTEM W/SPACER KIT		
1	FTS26065	COMPONENT BOX 1
1	FTS26066	COMPONENT BOX 2
1	FTS26010BK	TOYOTA 4WD SPACER BOX

K7047DL 6" PERFORMANCE SYSTEM W/DLSS COILOVERS		
1	FTS26065	COMPONENT BOX 1
1	FTS26066	COMPONENT BOX 2
1	FTS26059	2.5 DLSS COILOVERS NON RESI
2	FTS811222	2.25 DLSS NON RESI

K7049DL 6" PERF SYSTEM W/DLSS COILOVERS W/RESI		
1	FTS26065	COMPONENT BOX 1
1	FTS26066	COMPONENT BOX 2
1	FTS26055	2.5 DLSS COILOVERS W/RESI
2	FTS801222	2.25 DLSS W/RESI

FTS26065 COMPONENT BOX 1		
2	FT70123	TIE ROD END
1	FT70152BK	SWAY BAR DROP (DRIVER)
1	FT70151BK	SWAY BAR DROP (PASSENGER)
2	FT70213BK	REAR SHOCK EXTENSION BRACKET
1	FT70219	HARDWARE SUBASSEMBLY
1	FT70230D	SPINDLE (DRIVER)
1	FT70230P	SPINDLE (PASSENGER)

FTS26010BK SPACER KIT		
2	FT70055BK	STRUT SPACER

FTS26066 COMPONENT BOX 2		
4	FT1500U	UBOLT SQ 9/16-18X10.00X2.63
2	FT202	REAR ADD A LEAF
1	FT70215BK	FRONT CROSSMEMBER
1	FT70216BK	REAR CROSSMEMBER
1	FT70053	LOWER DIFF BRACKET (DRIVER)
1	FT70054	LOWER DIFF BRACKET (PASSENGER)
1	FT70217BK	BUMP STOP MOUNT (DRIVER)
1	FT70218BK	BUMP STOP MOUNT (PASSENGER)
1	FT70226BK	DIFF SKID PLATE
2	FT70075	CARRIER BEARING DROP
2	FT70220	CROSSMEMBER WELD-IN PLATE
1	FT70221	HARDWARE SUBASSEMBLY
2	FTBK3	LIFT BLOCK 3.0 IN

FT70221		HARDWARE SUBASSEMBLY
2	CB-06X5	CENTER PIN BOLT 3/8-24 X 5"
1	FT70014	E-BRAKE BRACKET ZINC
1	FT70060	E-BRAKE CABLE BRACKET (DRIVER)
1	FT70062	REAR BRAKE LINE BRACKET
1	FT70065	BRAKE LINE TAB REAR
2	FT70072	E-BRAKE CABLE BRACKET (FRAME)
1	FT70074	E-BRAKE CABLE BRACKET (PASSENGER)
1	FT90087	DIFF BUSHING KIT
2	FTS88	BUMPSTOP 1" TALL

FT70219		HARDWARE SUBASSEMBLY
2	FT133	SLEEVE .750 X .510 X 1.840
1	FT26065i	INSTRUCTIONS
2	FT70061	FRONT BRAKE LINE BRACKET
1	FT70063	SPINDLE BRAKELINE BRACKET (DRIVER)
1	FT70064	SPINDLE BRAKELINE BRACKET (PASSENGER)
2	FT70102	SWAY BAR MISALIGNMENT
2	FT70105	SWAY BAR END LINK
6	FT70159	SWAY BAR MISALIGNMENT SHORT
1	FT70224	HARDWARE KIT
4	FT95023	HEIM MALE 1/2" X 1/2"

FT70224 - HARDWARE KIT		LOCATION
BAG 1		
2	M20-2.50 X 120MM HEX BOLT	
4	M20 SAE WASHER	
2	M20-2.50 C-LOCK NUT	
2	5/8-11 X 5-1/2" HEX BOLT	
4	5/8" SAE WASHER	
2	5/8-11 C-LOCK NUT	
4	5/16" SAE FLAT WASHER	
2	5/16-18 C-LOCK NUT	
2	5/16-18 X 1-1/4" HEX BOLT	
6	1/2" SAE WASHER	
3	1/2-13 C-LOCK NUT	
1	1/2-13 X 1-1/2 HEX BOLT	
2	1/2-13 X 4" HEX BOLT	
8	1/8" X 2" COTTER PIN ZINC	
2	THREAD LOCKING COMPOUND	
BAG 2		
30	3/8" SAE WASHER	
2	3/8 LOCK WASHER	
18	3/8-16 C-LOCK NUT	
10	3/8-16 X 1-1/4" HEX BOLT	
2	3/8-16 X 2-1/2" BUTTON HEAD BOLT	
2	3/8-16 3" HEX BOLT	
2	3/8-16 NYLOCK NUT	
2	3/8" SAE WASHER	
2	1/2-13 X 3-1/2 HEX BOLT	
4	1/2-20 JAM NUT	
2	M10 FLAT WASHER	
2	M10-1.25 X 25MM HEX BOLT	
BAG 3		
2	M10-1.25 X 50MM HEX BOLT	
30	1/4 SAE WASHER	
12	1/4 LOCK WASHER	
9	1/4-20 C-LOCK NUT	
14	1/4-20 X 3/4" HEX BOLT	
7	1/4-20 X 1" HEX BOLT	
8	5/16 SAE WASHER	
4	5/16-18 C-LCOK NUT	
4	5/16-18 X 1" HEX BOLT	
2	7/16 USS WASHER	
9	CLAMP NEOPRENE	
2	CENTER PIN NUT	
8	9/16 SAE WASHER	
8	9/16-18 NYLOCK NUT	
4	M12 FLAT WASHER	
2	M12-1.75 X 60MM HEX BOLT	
2	M12-1.75 C-LOCK NUT	



- TOOL LIST -

Required Tools (Not Included)

Basic Hand Tools	Torque Wrench
Floor Jack	Die Grinder w/ Cutoff Wheel or Sawzall
Jack Stands	Welder
Assorted Metric and S.A.E sockets, and Allen wrenches	

- PRE-INSTALLATION NOTES -

For technical assistance call: **909-597-7800** or e-mail: **info@fabtechmotorsports.com**

READ THIS BEFORE YOU BEGIN INSTALLATION -

Check all parts to the parts list above before beginning installation. If any parts are missing contact Fabtech at 909-597-7800 and a replacement part will be sent to you immediately.

Read all instructions thoroughly from start to finish before beginning the installation. If these instructions are not properly followed severe frame, driveline and / or suspension damage may occur.

Check your local city and state laws prior to the installation of this system for legality. Do not install if not legal in your area.

Prior to the installation of this suspension system perform a front end alignment and record. Do not install this system if the vehicle alignment is not within factory specifications. Check for frame and suspension damage prior to installation.

The installation of this suspension system should be performed by two professional mechanics.

This suspension must be installed with Fabtech shock absorbers.

Use the provided thread locking compound on all hardware.

WARNING- Installation of this system will alter the center of gravity of the vehicle and may increase roll over as compared to stock.

Vehicles that receive oversized tires should check ball joints, uniballs, tie rods ends, pitman arm and idler arm every 2500-5000 miles for wear and replace as needed.

Verify differential fluid is at manufactures recommended level prior to kit installation. Installation of the kit will reposition the differential and the fill plug hole may be in a different position. (For example, if the manufacture recommends 3 quarts of fluid, make sure the diff has 3 quarts of fluid). Check your specific manual for correct amount of fluid.

You **Must** run a 17x8 wheel or larger with a 4-5/8" backspacing with this kit for proper wheel clearance.

FOOTNOTES -

- Cannot use OEM wheel and tire.
- Welding is required
- Kit does not fit standard cab model trucks.
- Will not work on TRD Pro models.

- INSTRUCTIONS -

FRONT SUSPENSION

1. Disconnect the negative terminal on the battery. Jack up the front end of the truck and support the frame rails with jack stands. **NEVER WORK UNDER AN UNSUPPORTED VEHICLE!** Remove the front tires.
2. Working from both sides of the truck, locate and remove the factory skid plate and the 2 support brackets. Discard skid plate and hardware, these will not be reinstalled on the truck. **SEE FIGURE 1**



FIGURE 1 - STEP 2

3. Remove factory mud flaps off front of the vehicle and discard.
4. Remove the nut from the tie rod ends. Disconnect the tie rod ends from the steering knuckle by striking the knuckle with a large hammer to dislodge the tie rod end. Use care as to not hit the threads on the tie rod end with the hammer as you will damage them. Save all hardware. **SEE FIGURE 2**

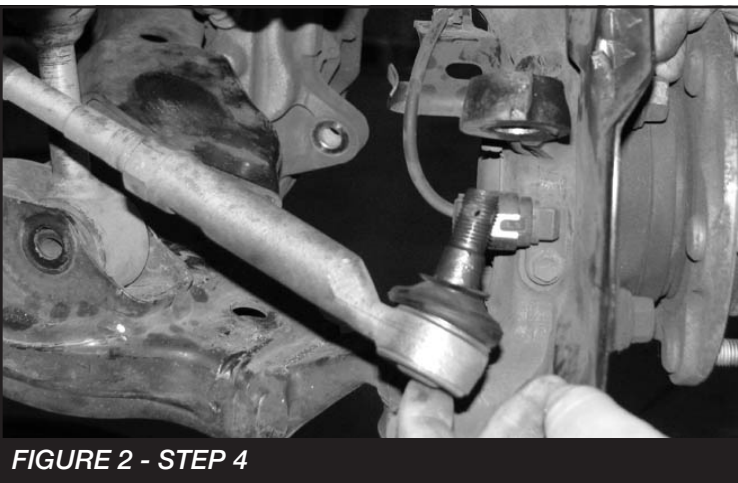

FIGURE 2 - STEP 4

5. Remove the sway bar end links from the factory steering knuckles and leave connected to the bar. Then remove the bar from the truck. Save the bar and end links with all hardware. **SEE FIGURE 3**



FIGURE 3 - STEP 5

6. Remove the brake caliper and brake rotor from the steering knuckle and hang out of the way. Do not allow the brake caliper to hang from brake line. Remove the brake line brackets from the knuckle. Trucks equipped with ABS brakes, unbolt the ABS line and disconnect from steering knuckle.
7. Remove the hub cover, the cotter pin, and axle nut. Remove the four hub bolts and remove the hub with the backing plate from the knuckle and CV shaft. Save all components and hardware. **Do not remove the CV axles from the front differential.**
8. Support the lower A-Arm with a floor jack. Loosen the upper ball joint nut. Disconnect the upper ball joint from the upper control arm by striking the knuckle with a large hammer next to the ball joint to dislodge the ball joint. Use care not to hit the ball joint when removing. Remove and save factory castle nut.
9. Remove the castle nut and two bolts on each side connecting the lower ball joint assembly to the knuckle. Save the Castle nut, as you will reuse it. Remove spindle assembly from truck. Remove remaining portion by striking with a large hammer next to the ball joint to dislodge. Use care not to hit the ball joint when removing. **SEE FIGURE 4**



FIGURE 4 - STEP 9

10. Remove the three upper nuts then the lower bolt from the shock assembly. Remove the shock assembly as one complete unit and save with the hardware if installing the spacer, discard if installing Dirt Logic coilovers. **SEE FIGURE 5-6**



FIGURE 5 - STEP 10

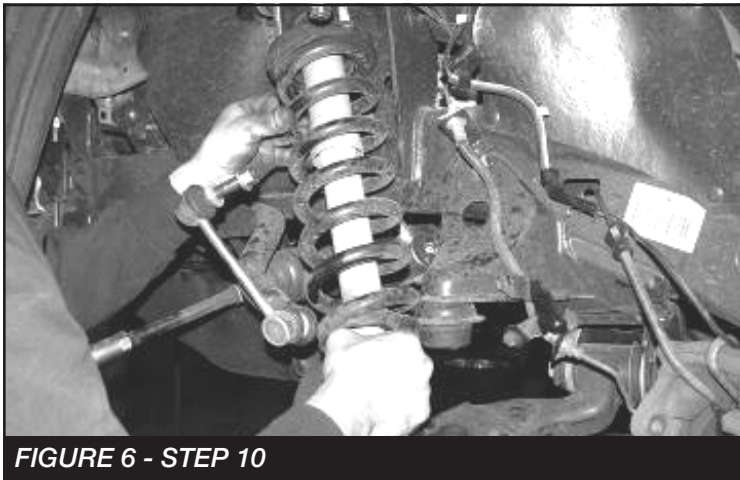

FIGURE 6 - STEP 10

11. Remove and save the factory lower control arms and hardware.

12. **Skip steps thirteen and fourteen for 2wd PreRunner model trucks.**

13. Disconnect the front drive shaft **ONLY** from the differential, do not disconnect from the transfer case. Save hardware. **Do not allow drive shaft to hang freely.**

14. Support the front differential with a transmission or floor jack. Disconnect all electrical, vacuum lines, and breather lines from the differential. Remove the rear differential nut and save as you will reuse it during assembly. Remove the two front differential bracket bolts from the frame. Discard the bolts, as you will not reuse them. **DO NOT SEPARATE THE C.V. AXLES FROM THE DIFFERENTIAL.** Remove the differential from the truck and set aside. **USE CARE WHEN REMOVING DIFFERENTIAL AS TO NOT DAMAGE THE C.V. Axels and 4WD VACUUM ACTUATOR ASSEMBLY. SEE FIGURE 7**

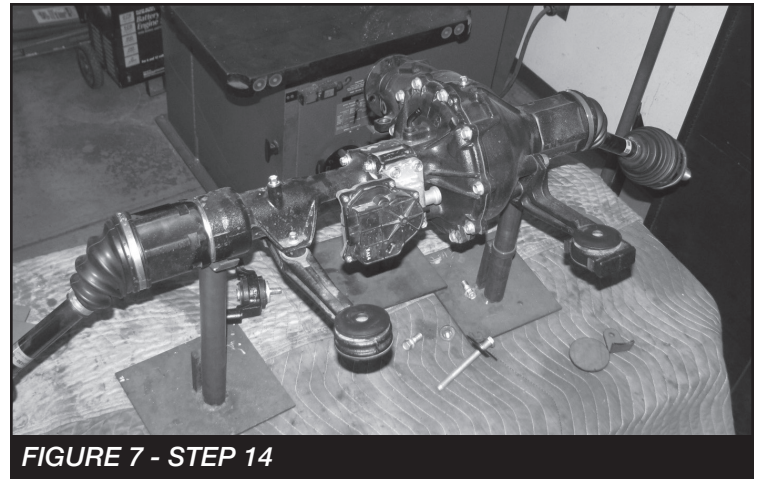

FIGURE 7 - STEP 14

15. On the top of the crossmember, locate the bottom hole and measure down 1/8", draw a line straight across the top of the crossmember. **SEE FIGURE 8** (Passenger side shown)

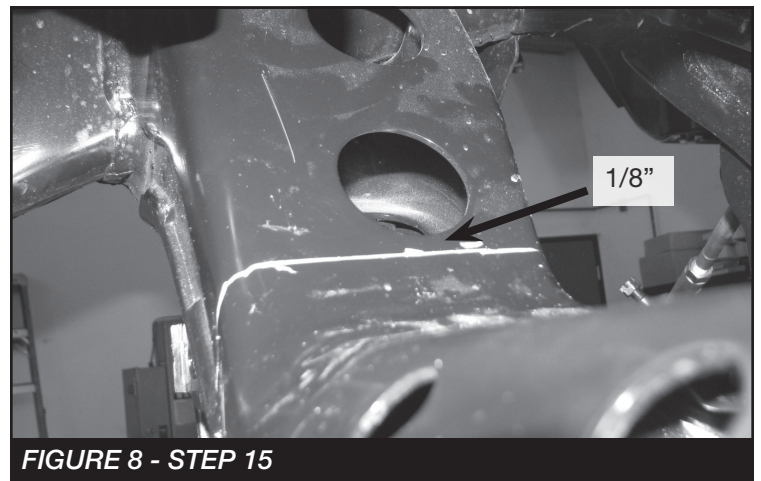

FIGURE 8 - STEP 15

16. On the bottom of the crossmember, locate the factory weld at the lower control arm pocket and crossmember. Mark a straight line just inside the weld. Connect the two lines around crossmember. **SEE FIGURE 9-10**

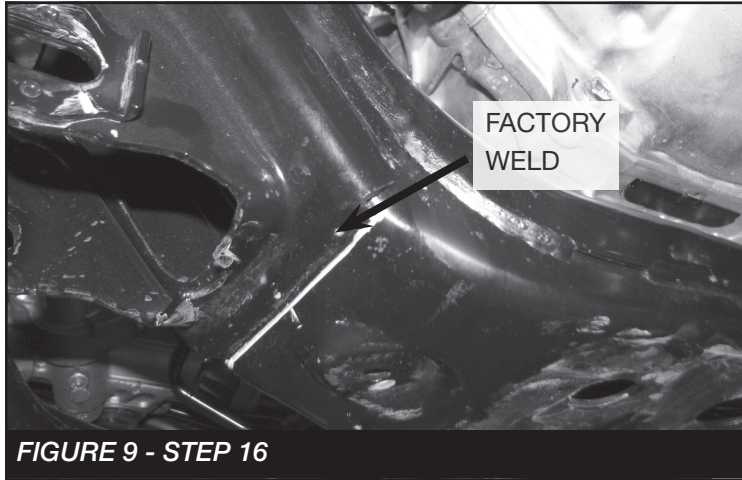

FIGURE 9 - STEP 16

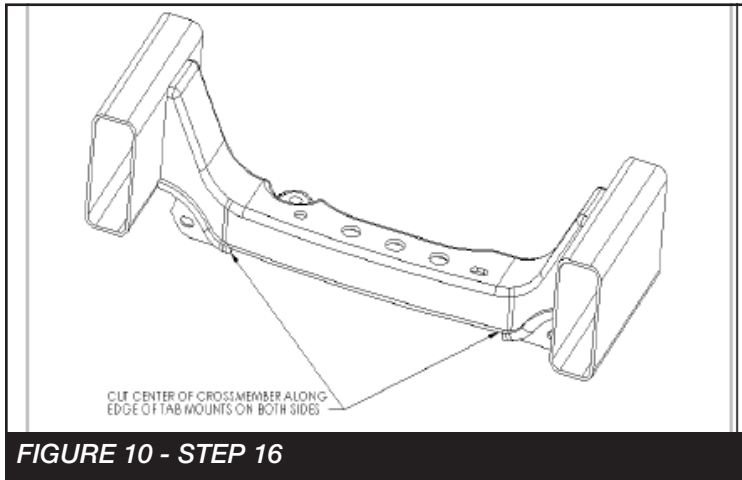

FIGURE 10 - STEP 16

17. Repeat Steps 15-16 on opposite side.

18. Take care to cut the crossmember straight up and down and to not cut into the control arm pocket itself or cut out the weld. Cut and remove the rear crossmember section. **SEE FIGURES 11-13**



FIGURE 11 - STEP 18



FIGURE 12 - STEP 18



FIGURE 13 - STEP 18

19. Locate FT70220 Weld in plates. You will need to weld in these plates to cover the holes made by cutting out the original crossmember. Clean area to bare metal weld in new plates. Let plate cool and paint with a corrosive resistant paint or under coating. **SEE FIGURES 14-15**



FIGURE 14 - STEP 19

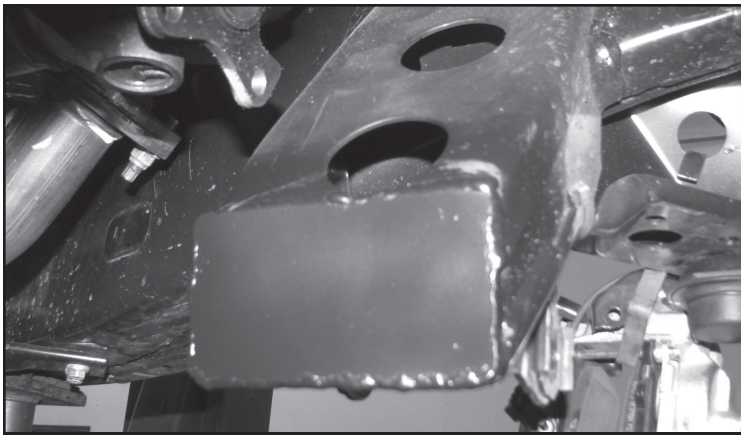

FIGURE 15 - STEP 19

20. Skip step 21 for 2wd PreRunner model trucks.

21. On the front differential, remove the factory front mounts. Discard the mounts and save the hardware. Locate FT70053 (Driver Diff mount), FT70054 (Pass Diff mount), and FT90087 Bushing and Sleeve Kit. Install the four bushings and the two larger I.D. sleeves into the new mounts. Using the factory hardware and some of the supplied thread-locking compound, mount the new diff mounts to the front differential. Torque the hardware to 160 ft. lbs. **SEE FIGURES 16-17**

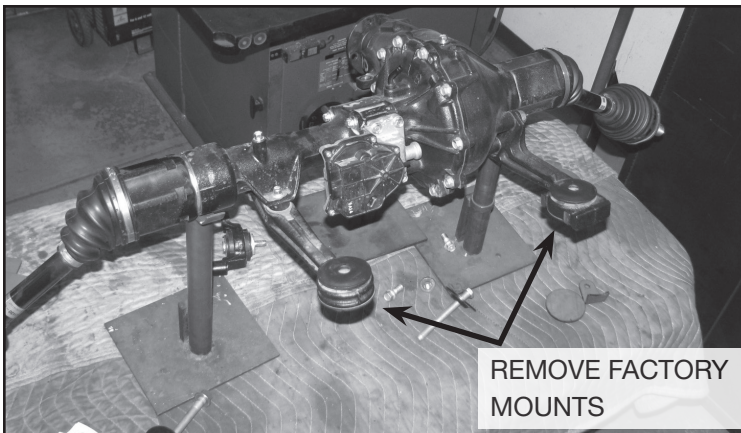

FIGURE 16 - STEP 21

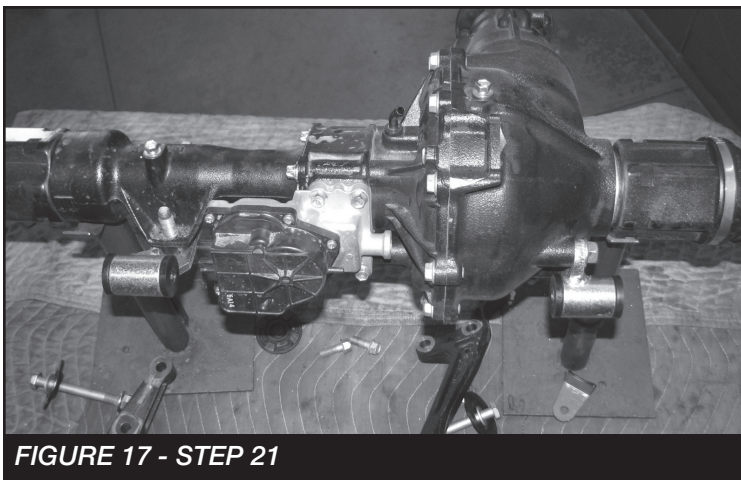

FIGURE 17 - STEP 21

22. Locate the Fabtech front crossmember FT70215BK, with the supplied 20mm X 120mm bolts, nuts, and washers, attach the crossmember to the factory control arm pockets, leave loose at this time. **(ON TWO WHEEL DRIVE TRUCKS, INSTALL REAR CROSSMEMBER WITH THE SUPPLIED 5/8" x 5-1/2" HARDWARE AT THIS TIME) SEE FIGURE 18**



FIGURE 18 - STEP 21

23. Skip steps 24- on 2wd Pre-Runner model trucks.

24. Install the differential up onto the front crossmember with the supplied 1/2" x 4" bolts and hardware. Support the differential with a transmission jack. Leave loose at this time. **SEE FIGURES 19-20**

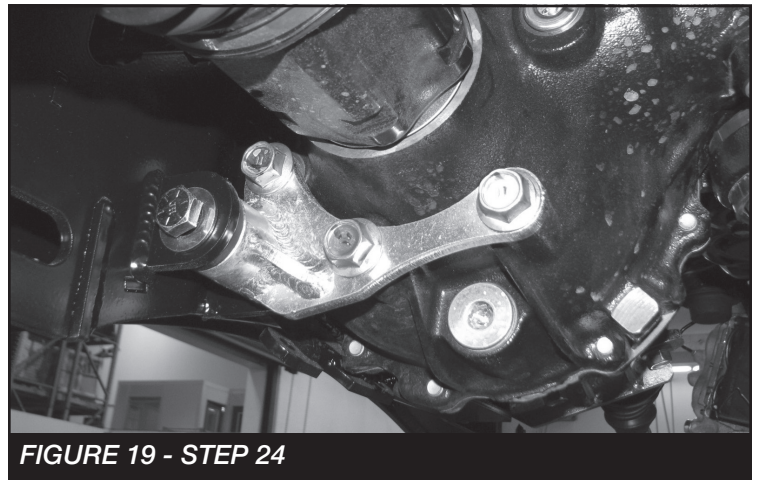

FIGURE 19 - STEP 24



FIGURE 20 - STEP 24

25. Locate the Fabtech rear crossmember FT70216BK and the supplied 5/8"x 5-1/2" bolts, nuts, and washers. Install the crossmember to the factory control arm pockets. Leave loose at this time. Re-install the factory rear differential nut. **SEE FIGURE 21**



FIGURE 21 - STEP 25

26. Locate the previously removed factory hardware for the front driveshaft and install with some of the supplied thread-locking compound on the bolts and torque to 50 ft lbs. Re-connect all electrical, vacuum lines, and breather lines back to the differential.

Continue installation for 2wd and 4wd

27. Install the factory lower control arms, using stock alignment bolts and hardware, leave loose. **SEE FIGURE 22**

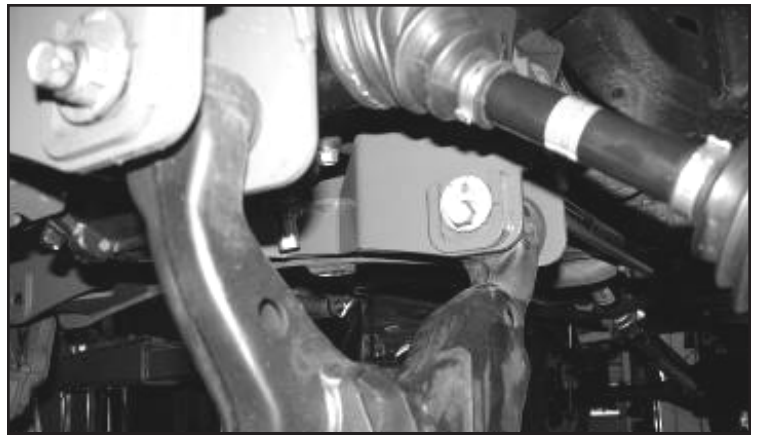

FIGURE 22 - STEP 27

28. Locate skid plate FT70226BK (skid plate). Attach using the supplied hardware (front mount) 5/16"x 1-1/4" bolts, nuts, and washers (rear mount) 1/2"x 1-1/2" bolt, nut, and washer. **SEE FIGURE 23**



FIGURE 23 - STEP 28

**FOLLOW STEP 29 FOR THE BASIC KIT
INSTALLATION**

OR

**FOLLOW STEP 30 FOR THE PERFORMANCE KIT
INSTALLATION**

29. Locate the factory shock assembly. Install the FT70055BK Coil Spacers using the factory hardware. **NOTE:** Position the spacer onto the top of the shock assembly so that the shortest side of the spacer is angled in towards the shock bucket. This must also align with the bottom mounting point of the shock assembly to mount into the lower control arm. Place the bottom of the shock into the lower shock mount and attach with the factory hardware. Install the supplied 3/8" nuts and washers at the upper mount. Torque the top 3/8" hardware to 52 ft-lbs., factory hardware to 52 ft. lbs., and the lower bolt to 100 ft.Lbs. **SEE FIGURE 24-25**

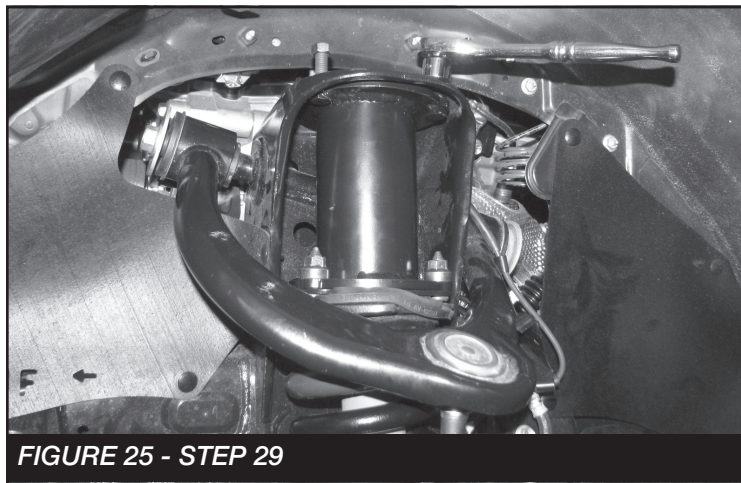
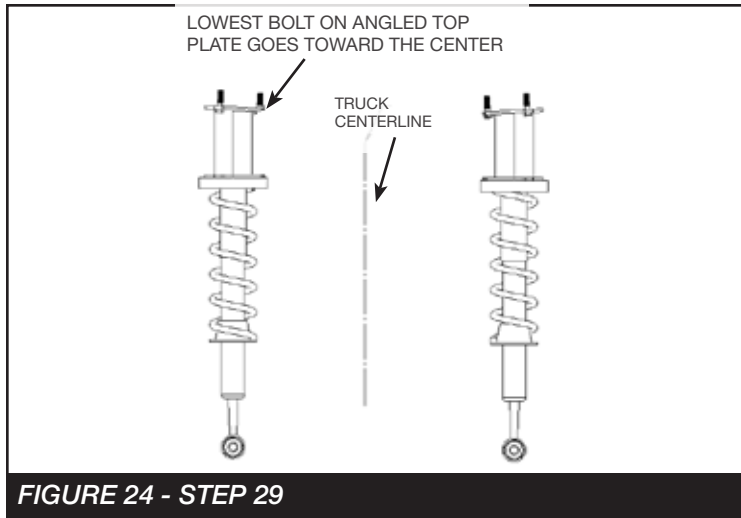

30. Locate and install FT825152 Coil Over or FT820152 Coilover w/Resi as described in the instructions enclosed with the coilovers. **SEE FIGURE 26**

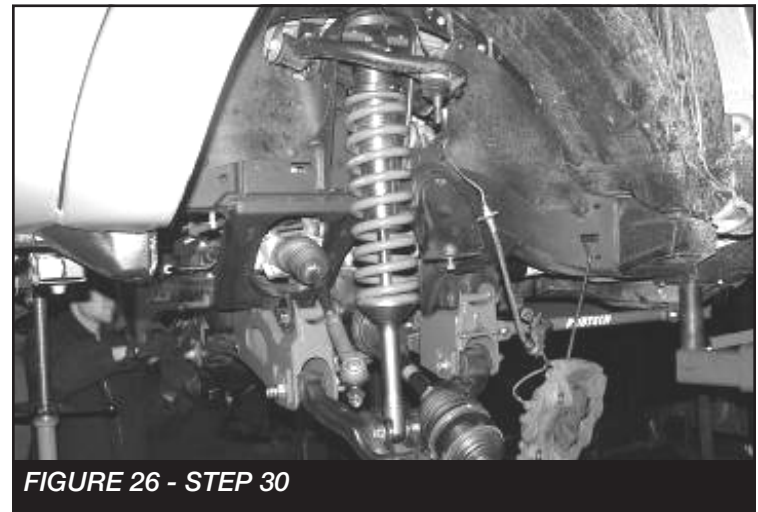

31. Locate the factory steering knuckles and remove the hubs, backing plates, inner seal, and the dust covers. The factory dust shield will need to be trimmed. Refer to **FIGURE 27**. Locate the new Fabtech FT70230D and FT70230P steering knuckles. Install the factory inner seals, factory hubs, backing plates, and the dust covers with the factory hardware and supplied thread-locking compound. Torque factory hub bolts to 100 ft-lbs. **SEE FIGURE 28-29** **NOTE: 2wd models have a dust shield that must be taken out of the stock knuckle and installed in the new Fabtech knuckle.**





FIGURE 28 - STEP 31



FIGURE 29 - STEP 31

32. Support the lower arm with a floor jack and install the new assembled steering knuckle to the lower ball joint with the factory castle nut and supplied cotter pin. Raise the jack enough to install the knuckle up into the upper ball joint and attach with the factory castle nut and supplied new cotter pin. Torque to 35 ft.lbs. **SEE FIGURE 30**

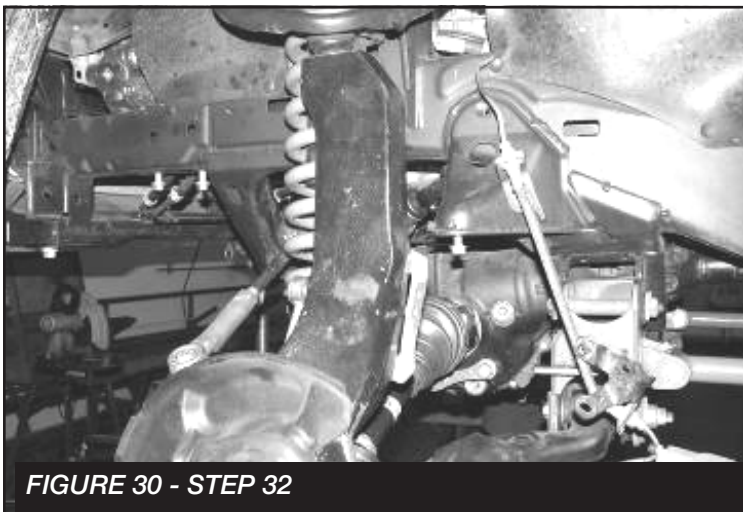

FIGURE 30 - STEP 32

33. Torque control arm pocket bolts to 100 ft. lbs., the 20mm front crossmember bolts to 300 ft. lbs., the 5/8" rear crossmember bolts to 254 ft. lbs., the 1/2" differential mounts to 127 ft. lbs., the 1/2" skid plate bolt to 127 ft. lbs., the 5/16" skid plate bolts to 29 ft. lbs.
34. Locate the factory brake line tab next to upper control arm. Unbolt the bracket from the frame save hardware and bracket. You will need to carefully pull the hard brake line down 4". Locate FT70061 brake line drop bracket and attach the bracket to the frame with the factory hardware in the upside down J formation. Attach factory bracket to the new bracket using the supplied 5/16" x 1" bolt, nut, and washers. **SEE FIGURE 31**

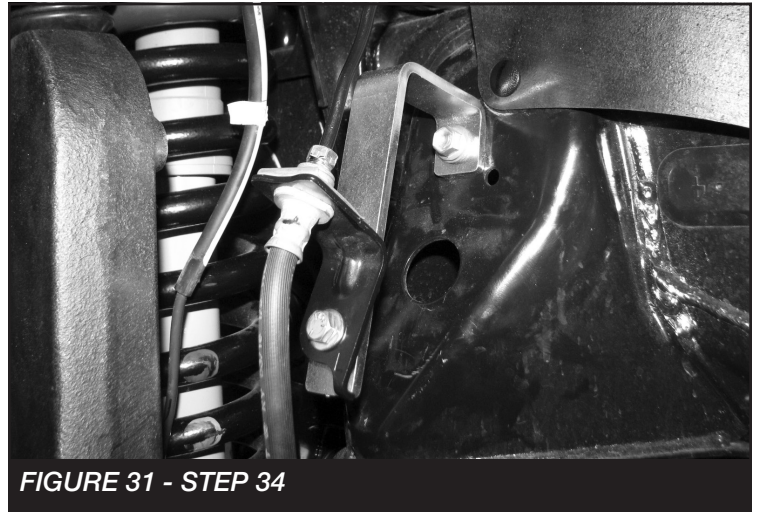

FIGURE 31 - STEP 34

35. Locate the FT70063 & FT70064 (drv. / pass.) spindle brake line brackets. Attach to the Fabtech knuckle using the supplied 1/4" x 3/4" bolts, washers, and split washers. **SEE FIGURE 32.** Attach the factory bracket to the new brake line bracket using the supplied 1/4" x 3/4" bolt, washer, & split washer. Torque to 14 ft-lbs **SEE FIGURE 33**



FIGURE 32 - STEP 35

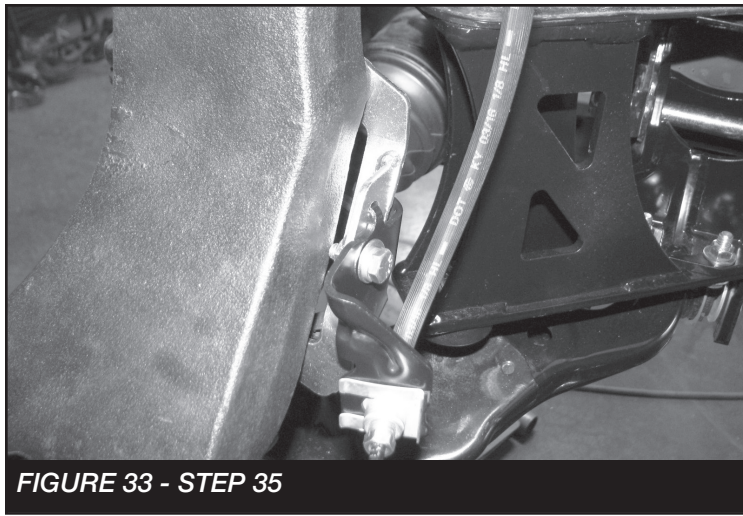

FIGURE 33 - STEP 35

36. Remove the factory ABS line bracket attached to the upper control arm. This will not be reinstated. **SEE FIGURE 34**

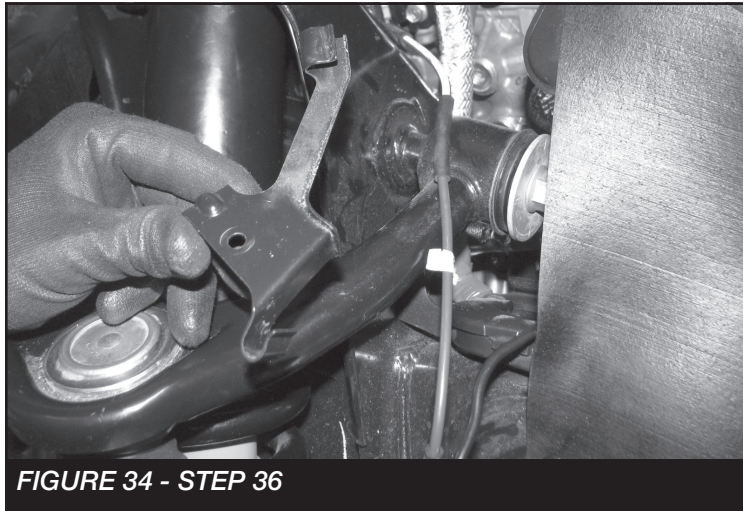

FIGURE 34 - STEP 36

37. Install brake rotors & brake calipers with the factory hardware and thread lock compound. Route the ABS onto backside of the steering knuckle. To do this you must loosen the clips that hold the ABS line in place. There should be enough slack just inside the wheel well to pull the line down for the factory sensor to bolt into the new Fabtech steering Knuckle. Using the supplied adel clamps and the 1/4" x 3/4" bolts, washers, & split washers, reinstall the factory ABS Sensor into the Fabtech Knuckle. Torque to 14 ft-lbs **SEE FIGURES 35-36**. Now attach the new FT70123 tie rod ends with the supplied castle nut and cotter pin. **SEE FIGURE 37**

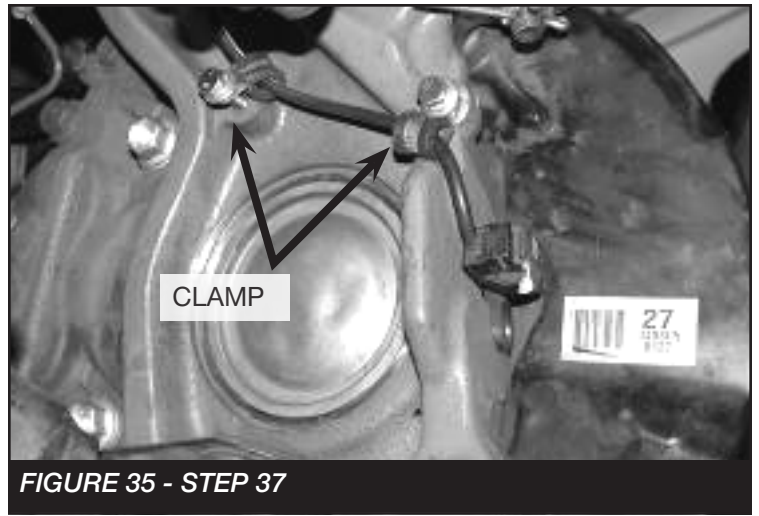

FIGURE 35 - STEP 37

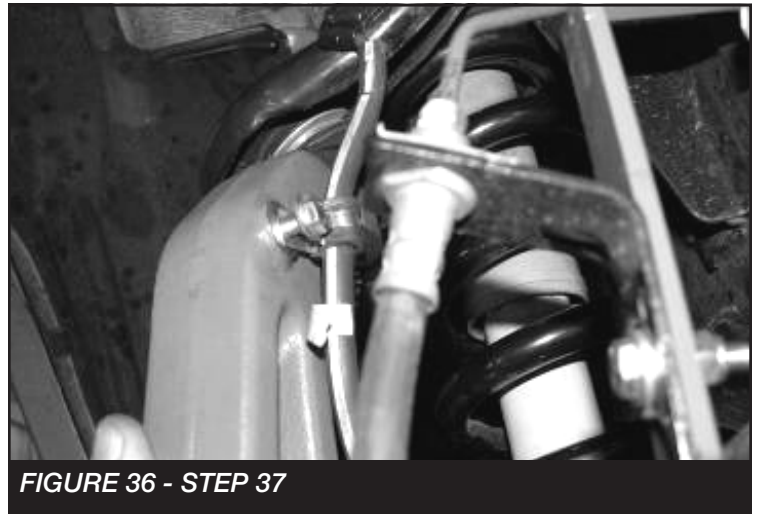

FIGURE 36 - STEP 37



FIGURE 37 - STEP 37

38. Remove factory bump stop and discard. Locate FT70217BK (drv.) & FT70218BK (pass.) bump stop drop bracket. Attach the top of the bracket to the factory bump stop position using the supplied 10mm x 25mm bolt and washer. Attach the two bottom holes of the bracket to the rear Fabtech crossmember, using the supplied 3/8" x 1 1/4" bolts, nuts, & washers. Now locate the supplied FTS88 Bump Stop and attach to the new bump stop bracket using the supplied 3/8" nut, & washer. Torque the 10mm hardware to 58 ft-lbs and the 3/8" to 52 ft-lbs. **SEE FIGURES 38-39**

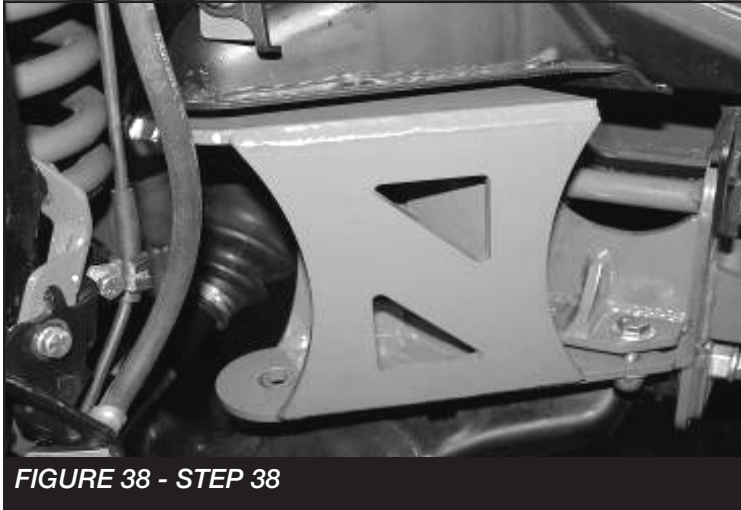

FIGURE 38 - STEP 38



FIGURE 39 - STEP 38

39. Locate FT70152BK Driver Sway Bar Drop Bracket, FT70151BK Pass. Sway Bar Drop Bracket and the factory sway bar, with hardware. Also locate the supplied 3/8" x 1 1/4" hardware. Position the new drop bracket on the frame so the sway bar will be mounted forward of its factory position and attach with the factory hardware.
40. Install the sway bar to the new drop brackets with the supplied 3/8" hardware. (The sway bar will need to be mounted upside down from the factory position). Torque to 52 ft-lbs **SEE FIGURE 40**

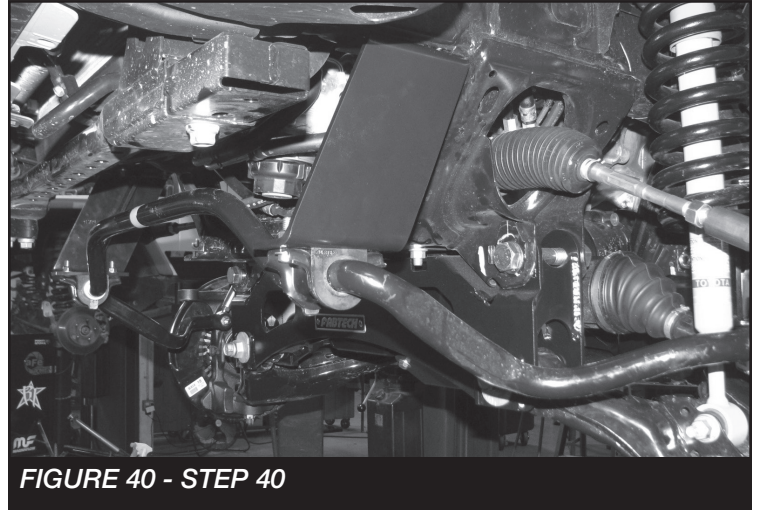

FIGURE 40 - STEP 40

41. Locate FT70105 (Sway Bar End Link), FT95023 (1/2" Heims), and supplied 1/2" Jam Nuts. Thread the jam nuts all the way onto the heims. Insert an assembled heim into each end of the end links and leave loose. Locate FT70102 (sway bar hat) and the supplied 3/8" button head bolt and hardware. Insert the hat and FT70159 alignment into the heim on one end and attach to the sway bar. **SEE FIGURE 41.** Locate FT70159 misalignments and the supplied 3/8" x 3" hardware. Insert the misalignments into the upper heim and attach it to the Fabtech steering knuckle. Torque the 3/8" hardware to 52 ft. lbs. **SEE FIGURE 42**

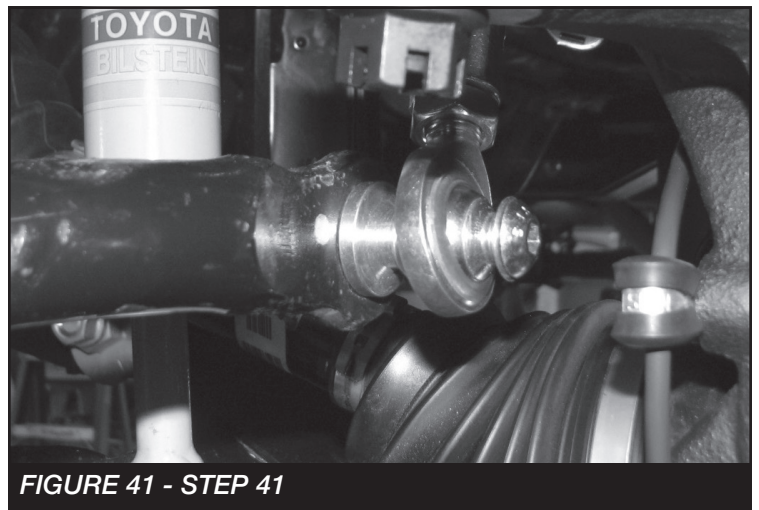

FIGURE 41 - STEP 41

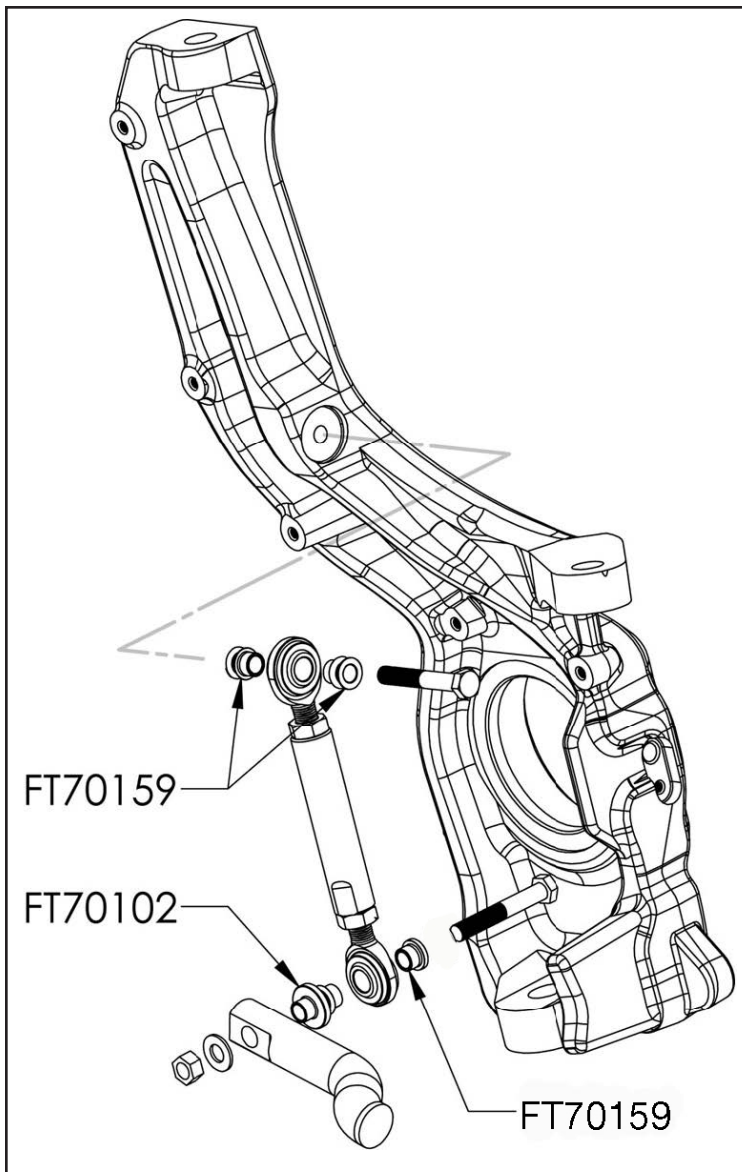

FIGURE 42 - STEP 41

42. Reinstall the wheels and tires and torque to the wheel manufactures specs. Turn wheels left to right to check for proper clearance between brake lines / ABS Lines to tires and wheels with vehicle hanging and on the ground. Reroute lines as required for clearance.

REAR SUSPENSION

43. Jack up the rear end of the vehicle and support the frame rails with jack stands. Supporting the rear differential disconnect the rear shocks from the axle, save hardware. If installing Dirt logic rear shocks remove and discard the factory shocks.
44. Disconnect all brake line brackets and remove all ABS lines from plastic clips from the rear axel. Disconnect ABS line bracket from the center of the axel. Next disconnect ABS lines from backing plate. Now disconnect E-Brake line brackets off at the mid leaf and front pivot points. Save all hardware and brackets.

45. Supporting the rear differential remove and discard the factory u- bolts and blocks. Lower the axle down slowly. Use care not to over extend the brake hose.
46. Clamp the leaf spring in the middle of the spring and remove the center bolt. Separate the springs and install the provided add a leaf with the new center bolt, the spring pack should form a pyramid pattern, from smallest on the bottom to the longest on top. The factory flat overload leaf will remain on the bottom of the pack. Clamp the spring and tighten the center bolt as not to leave a gap between the springs. Cut the thread of the bolt smooth with the nut. The nut should be on the top of the leaf spring pack. Torque to 52-ft-lbs.
47. Locate and install the rear lift blocks with the provided short center pin on the bottom of the block, to the axle. The short end of the block should face to the front of the vehicle. (The Block Is Marked Front.) Using the provided U-bolts, nuts, and washers align axle, lift blocks, stock bump stop, and springs and torque to U-Bolts to 184 ft-lbs. **SEE FIGURE 43**



FIGURE 43 - STEP 47

48. Locate FT70065 rear brake line small tab driver side. Attach to the factory perch using the factory hardware. Attach the factory bracket using the supplied 1/4" x 1" bolt, nut, & washers. **SEE FIGURE 44**

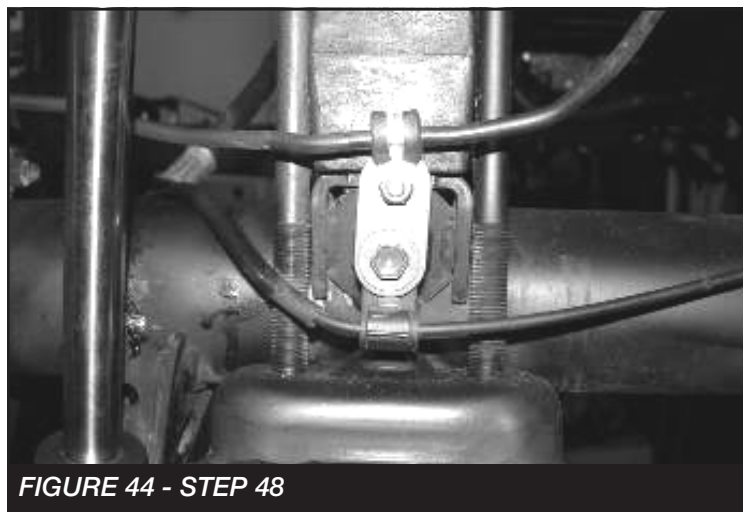

FIGURE 44 - STEP 48

49. Locate FT70014 (brake line bracket rear axle). Attach to the factory perch using the factory hardware. Attach the factory bracket to the new drop bracket using the supplied 5/16" x 1" bolt, nut, & washer. Torque to 29 ft-lbs **SEE FIGURE 45**

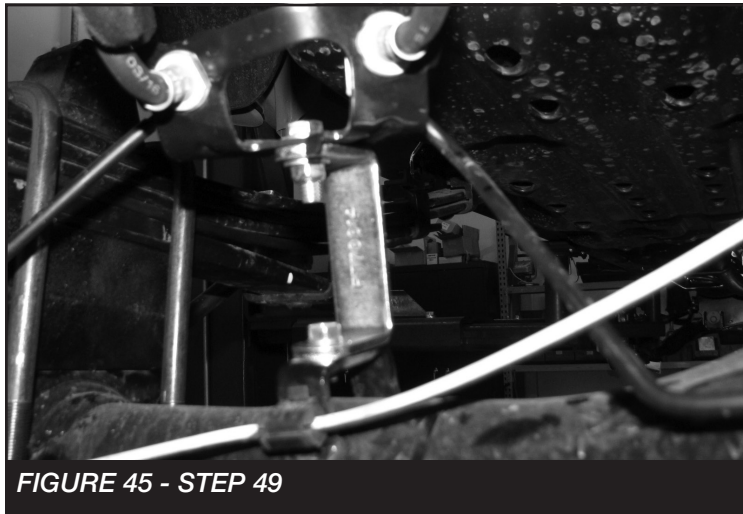

FIGURE 45 - STEP 49

50. Locate FT70062 (ABS line bracket). Attach it to the factory ABS Perch using the factory hardware. Attach the factory ABS bracket to the new bracket using the supplied 5/16" x 1" bolt, nut, & washers. Torque to 29 ft-lbs **SEE FIGURE 46**

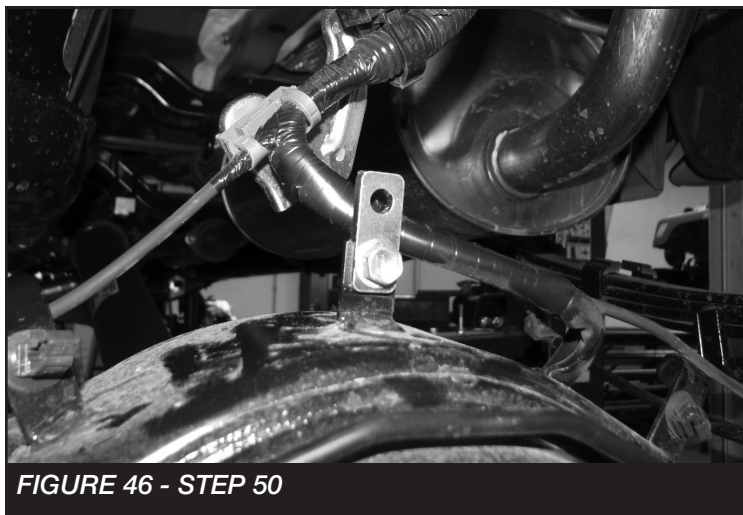

FIGURE 46 - STEP 50

STEP 51 SHOULD ONLY BE PERFORMED IS VEHICLE IS EQUIPPED WITH A TWO PIECE REAR DRIVESHAFT.

51. Locate FT70075 (Carrier Bearing Drop Spacer) and the supplied 10mm x 50mm bolts and washers. Remove the factory hardware from the carrier bearing mount and discard. Insert the drop spacer between the carrier bearing and the factory mount, with the new 10mm bolts and washers. Use the supplied thread locking compound and torque to 40 ft. lbs. **SEE FIGURES 47-48**

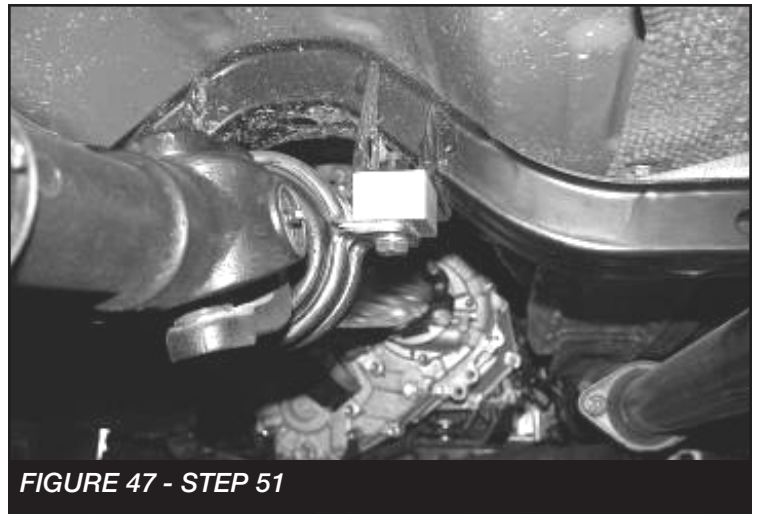

FIGURE 47 - STEP 51

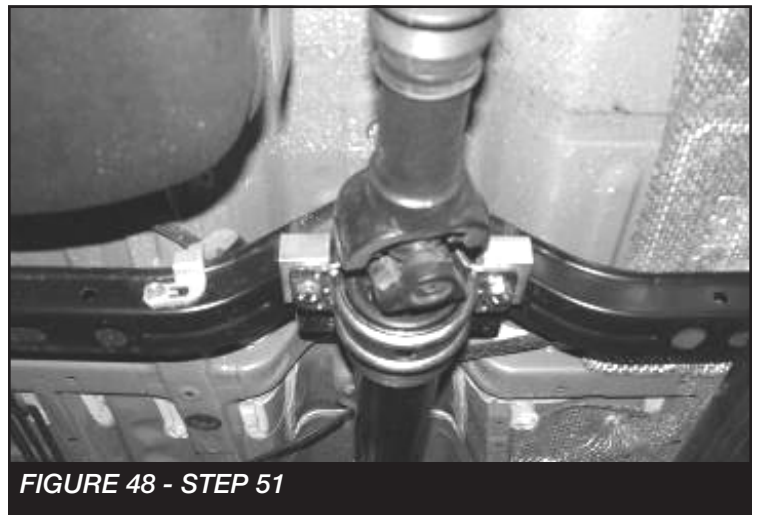

FIGURE 48 - STEP 51

52. Install FT70060 (Driver leaf mid point bracket.) and FT70074 (pass.) using the supplied 1/4" x 1" nuts, bolts, & washers. Make sure the bolt runs from the inside out towards the backing plate. Torque to 14 ft-lbs **SEE FIGURE 49**



FIGURE 49 - STEP 52

- 53. NOTE: If installing Dirt Logic shocks do so at this time WITHOUT the Fabtech rear shock extension. Install the FT70213BK (rear shock ext) using the factory hardware and the M12 hardware supplied. Torque to 100 ft-lbs SEE FIGURE 50**



FIGURE 50 - STEP 53

54. Recheck all bolts for proper torque. Recheck brake hoses and lines for proper clearances.
55. Install tires and wheels and torque lug nuts to wheel manufacturer's specifications. Turn front tires left to right and check for appropriate tire clearance. **Note - Some oversized tires may require trimming of the front bumper & valance.**
56. Check front end alignment and set to factory specifications. Readjust headlights.
57. Recheck all bolts for proper torque.
58. Recheck brake hoses, ABS wires and suspension parts for proper tire clearance while turning tires fully left to right.
59. Check the fluid in the front and rear differential and fill if needed with factory specification differential oil. **Note - some differentials may expel fluid after filling and driving. This can be normal in resetting the fluid level with the new position of the differential/s.**
60. Install Driver Warning Decal. Complete product registration card and mail to Fabtech in order to receive future safety and technical bulletins on this suspension.

Vehicles that will receive oversized tires should check ball joints, uniballs and all steering components every 2500-5000 miles for wear and replace as required.

RE-TORQUE ALL NUTS, BOLTS AND LUGS AFTER 50 MILES AND PERIODICALLY THEREAFTER.

For technical assistance call: **909-597-7800**

- Product Warranty and Warnings -

Fabtech provides a Limited Lifetime Warranty to the original retail purchaser who owns the vehicle, on which the product was originally installed, for defects in workmanship and materials.

The Limited Lifetime Warranty excludes the following Fabtech items; bushings, bump stops, ball joints, tie rod ends, limiting straps, cross shafts, heim joints and driveshafts. These parts are subject to wear and are not considered defective when worn. They are warranted for 60 days from the date of purchase for defects in workmanship.

Dirt Logic and Performance Coilover take apart shocks are considered a serviceable shock with a one year warranty on leakage only. Service seal kits are available separately for future maintenance. All other shocks are covered under our Limited Lifetime Warranty.

Fabtech does not warrant any product for finish, alterations, modifications and/or installation contrary to Fabtech's instructions. Alterations to the finish of the parts including but not limited to painting, powder coating, plating and/or welding will void all warranties. Some finish damage may occur to parts during shipping, which is considered normal and is not covered under warranty.

Fabtech products are not designed nor intended to be installed on vehicles used in race applications or for racing purposes or for similar activities. (A "RACE" is defined as any contest between two or more vehicles, or any contest of one or more vehicle against the clock, whether or not such contest is for a prize). This warranty does not include coverage for police or taxi vehicles, race vehicles, or vehicles used for government or commercial purposes. Also excluded from this warranty are sales outside of the United States of America.

Installation of most suspension products will raise the center of gravity of the vehicle and will cause the vehicle to handle differently than stock. It may increase the vehicle's susceptibility to a rollover, on road and off road, at all speeds. Extreme care should be taken to operate the vehicle safely at all times to prevent rollover or loss of control resulting in serious injury or death. Fabtech front end Desert Guards may impair the deployment or operation of vehicles equipped with supplemental restraining systems/air bag systems and should not be installed if the vehicle is equipped as so.

Fabtech makes every effort to ensure suspension product compatibility with all vehicles listed on the website, but due to unknown auto manufacturer's production changes and/or inconsistencies by the auto manufacturer, Fabtech cannot be responsible for 100% compatibility, including the fitment of tire and wheel sizes listed. The Tire and Wheel sizes listed in Fabtech's website are only a guideline for street driving with noted fender trimming. Fabtech is not responsible for damages to the vehicle's body or tires. Fabtech is not responsible for premature wear of factory components due to the installation of oversized tires and wheels.

Fabtech's obligation under this warranty is limited to the repair or replacement, at Fabtech option, of the defective product only. All costs of removal, installation or re-installation, freight charges, incidental or consequential damages are expressly excluded from this warranty. Fabtech is not responsible for damages and/or warranty of other vehicle parts related or non related to the installed Fabtech product. This warranty is expressly in lieu of all other warranties expressed or implied. This warranty shall not apply to any product that has been subject to accident, negligence, alteration, abuse or misuse as determined by Fabtech.

Fabtech suspension components must be installed as a complete system including shocks as shown on our website. All warranties will become void if Fabtech parts are combined and/or substituted with other aftermarket suspension products. Combination and/or substitution of other aftermarket suspension parts may cause premature wear and/or product failure resulting in an accident causing injury or death. Fabtech does not warrant products not manufactured by Fabtech.

Depending on the condition of the factory suspension components retained after the installation of a Fabtech suspension not all vehicles may have the same ride stance front to rear as described in the website. The blue color of suspension components shown in all Fabtech photographs are for display purposes only. Majority of all Fabtech components will be black specifically where noted with part numbers ending in BK.

Installation of Fabtech product may void the vehicles factory warranty; it is the consumer's responsibility to check with their local vehicle's dealer for warranty disposition before the installation of the product. Some state laws may prohibit modification of suspension to a vehicle in whole or in part. It is the responsibility of the installer and consumer to consult local laws prior to the installation of any Fabtech suspension product to comply with such written laws.

It is the responsibility of the distributor and/or the retailer to review all warranties and warnings of Fabtech products with the consumer prior to purchase.

Fabtech reserves the right to super cede, discontinue, change the design, finish, part number and/or application of parts when deemed necessary without written notice. Fabtech is not responsible for misprints or typographical errors within the website or price sheet. For the most recent Product Warranty and Warnings visit our website www.fabtechmotorsports.com