

921877200F

ROUGH COUNTRY
 SUSPENSION SYSTEMS®

1877BAG11

Nissan 2016 Titan XD 6" Suspension Kit

Thank you for choosing Rough Country for all your suspension needs.

Rough Country recommends a certified technician install this system. In addition to these instructions, professional knowledge of disassemble/reassembly procedures as well as post installation checks must be known. Attempts to install this system without this knowledge and expertise may jeopardize the integrity and/or operating safety of the vehicle.

Please read instructions before beginning installation. Check the kit hardware against the kit contents on the next page. Be sure you have all needed parts and know where they go. Also please review tools needed list and make sure you have needed tools.

PRODUCT USE INFORMATION

▲WARNING As a general rule, the taller a vehicle is, the easier it will roll. We strongly recommend, because of rollover possibility, that seat belts and shoulder harnesses should be worn at all times. Avoid situations where a side rollover may occur.

Generally, braking performance and capability are decreased when larger/heavier tires and wheels are used. Take this into consideration while driving. Do not add, alter, or fabricate any factory or after-market parts to increase vehicle height over the intended height of the Rough Country product purchased. Mixing component brands is not recommended.

Rough Country makes no claims regarding lifting devices and excludes any and all implied claims. We will not be responsible for any product that is altered. We will be happy to answer any questions concerning the design, function, and correct use of our products by calling our toll free number @ 1-800-222-7023.

▲WARNING Prior to installation, carefully inspect the vehicle's steering and driveline systems paying close attention to the tie rod ends, ball joints, and wheel bearing preload. Additionally check the steering to frame and suspension to frame attaching points for stress cracks. The overall vehicle must be in excellent working condition. Repair or replace all worn or damaged parts.

This kit is packaged as a leveling kit—raising the front 6" and the rear 4".

Due to differences in manufacturing, dimension and inflated measurements, tire and wheel combinations should be test fit prior to installation. For this application we recommend a 20" or larger wheel not to exceed 9" in width with a back-spacing of 5". Additionally a quality tire of radial design is recommended, not exceeding 35" tall and 12.5" wide is recommended. Please note that use of a 35" x 12.5" tire may require modification to the front valance.

▲NOTICE NOTICE TO DEALER AND VEHICLE OWNER

Install the supplied "Warning to Driver" decal installed on the inside of the windshield or on the vehicle's dash. The decal should act as a constant reminder for whoever is operating the vehicle of its unique handling characteristics.

We hope installing your Rough Country lift kit is a positive experience. Please note that variations in construction and assembly in the vehicle manufacturing process will virtually ensure that some parts may seem difficult to install. Additionally, the current trend in manufacturing of vehicles results in a frame that is highly flexible and may shift slightly on disassembly prior to installation. The use of pry bars and tapered punches for alignment is considered normal and usually does not indicate a faulty product. However, if you are uncertain about some aspect of the installation process, please feel free to call our tech support department at 800-222-7023. We do not recommend that you modify the Rough Country parts in any way as this will void any warranty expressed or implied.



KIT CONTENTS

Please confirm that you have all the needed parts and know where they go prior to beginning installation.

1877Box1

Front Cross Member
Rear Cross Member

1877Box2

Dr Knuckle

1877Box3

Pass Knuckle

1877Box5

Skid Plate
1877BAG4

1877Box12

Bump Stop Spacers (2)
Differential Drop Brckts (2)
Fr Sway Bar Links (2)
Fr Brake Line Brackets (2)
Bump Stop Flag Nuts (2)
Front Strut Spacer (2)
Bumper Shims (2)
Transmission Shim
1877BAG3
1877BAG5
1877BAG9
10MMSTUDBAG-1

1877Box10

Rear Blocks (2)
RR Sway Bar Links (2)
RR Brake Line Brackets (2)
E-brake Bracket
Front Strut Spacer (2)
Bumper Shims (2)
Transmission Shim
1263BAG2
9/16BAG
9/16 x 3 x 13 Ubolts (4)
658794 Shocks (2)
1698BAG3

Hardware Bags

1877BAG11

Instructions

1877BAG5

For Front Cross Member
5/8" x 5" Bolt (2)
5/8" Nylon Lock Nuts (2)
5/8" Washers (4)
For Rear Cross Member
5/8" x 5" Bolt (1)
5/8" Washers (2)
5/8" Nylon Lock Nut (1)
14mm x 35mm Bolt (1)
14mm Flat Washer (1)
5/8" x 2" Bolts (1)
5/8" Flat Washers (2)
5/8" Nylon Lock Nuts (1)
For Differential Drop Brackets
7/16" x 1.25" Bolts (8)
7/16" Flat Washers (8)
7/16" Nylock Nuts (8)

1263BAG2

For Anti-wrap Ubolts
7/16" x 3.125" x 3.25" Ubolts (4)
7/16" Flat Washers (8)
7/16" Nylock Nuts (8)

1877BAG3

For FR Differential Vent Hose
1/4" Differential Vent Hose Ext
1/4" Hose Coupler
For RR Differential Vent Hose
3/16" Differential Vent Hose Ext
3/16" Hose Coupler
For Front Brake Line Brkts
Front Brake Line Brkt (2)
3/8" x 1" Bolt (2)
3/8" Nylon Lock Nut (2)
3/8" Washer (4)
For Bump Stop Ext.
3/8" x 1.25" Bolt (2)
3/8" Washer (2)
For Fr Brake Line Brackets
5/16" x 1/2" Self Tapping Bolts (4)
5/16" x 1.25" Bolts (4)
5/16" Flat Washer (8)
5/16" Flange Locknut (4)
For Fr Bumper Shims
10mm x 35mm Bolts (6)
10mm Flat Washers (6)
For Rr Differential Vent Hose
3/16" Differential Vent Hose Ext
3/16" Hose Coupler
For Emergency Brake Bracket
5/16" x 1" Bolts (2)
5/16" Flat Washers (2)
5/16" Flange Locknuts (2)
For FR & Rr Sway Bar Links
12mm x 65mm Bolts (8)
12mm Flat Washers (16)
12mm Flange Locknut (8)
For Rr Brake Line Bracket
8mm x 15mm Bolts (2)
8mm Flat Washers (2)
5/16" x 1.25" Bolts (2)
5/16" Flat Washers (2)
5/16" Flange Locknuts (2)

1877BAG4

For Skid Plate
3/8" x 1.25" (7)
3/8" Flat Washers (7)

9/16Bag

For Ubolts
9/16" Lock Nut (8)
9/16" Washer (8)

10MMSTUDBAG-1

For Strut Spacers
10mm Studs (6)
10mm Nuts (6)
10mm Lock Washers (6)

1698BAG3

For Rear Sway Links
Sleeves (4)





Torque Specs:

Size	Grade 5	Grade 8
5/16"	15 ft/lbs	20 ft/lbs
3/8"	30 ft/lbs	35 ft/lbs
7/16"	45 ft/lbs	60 ft/lbs
1/2"	65 ft/lbs	90 ft/lbs
9/16"	95 ft/lbs	130 ft/lbs
5/8"	135 ft/lbs	175 ft/lbs
	Class 8.8	Class 10.9
8MM	18ft/lbs	23 ft/lbs
12MM	55ft/lbs	75ft/lbs

Tools Needed:

- Floor jack
- Jack stands
- Ratchet
- Drill Motor
- 13/32" Drill
- 11/16" Drill
- 3/4" Drill
- Reciprocating Saw
- 13/16" socket
- 5mm Allen
- 6mm Allen
- 10mm Socket
- 12mm Socket
- 14mm Socket
- 15mm Socket
- 17mm Socket
- 19mm Socket
- 21mm Socket
- 22mm Socket
- 24mm Socket
- 30mm Socket
- 1/2" Socket
- 32mm Socket
- 9/16" Socket
- 13/16" Socket
- 3/4" Socket
- Pliers
- Hammer
- Torque Wrench



FRONT INSTALLATION INSTRUCTIONS

1. Jack up the front of the vehicle and support the vehicle with jack stands, so that the front wheels are off the ground
2. Using 21mm socket remove the front tires/wheels.
3. Remove the cotter pin from the tie rod end. **See Photo 1.**
4. Using a 22mm wrench, loosen the tie rod end nut. **Do not remove.** **See Photo 2.**

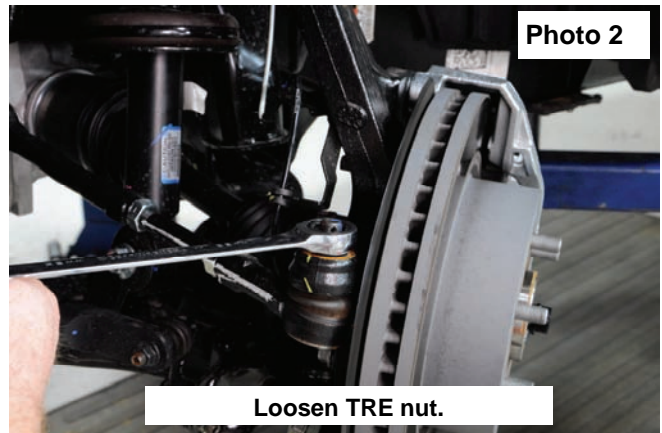
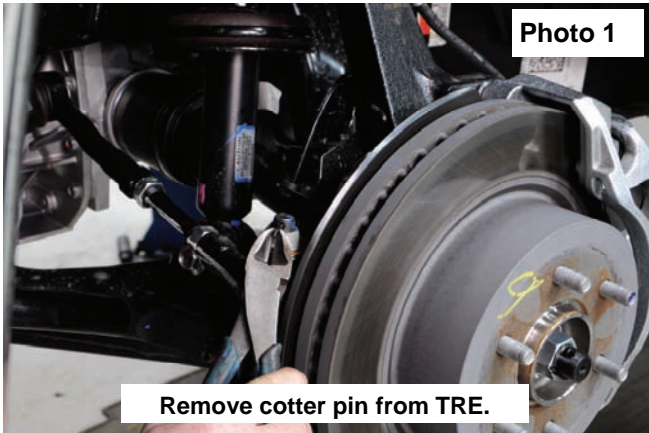

5. Using a hammer, strike the side of the knuckle at the tie rod end to release the taper. Remove nut and move tie rod out of the way. **See Photo 3.**
6. Using a 13mm socket, remove the nut from the brake line bracket. **Photo 4.**

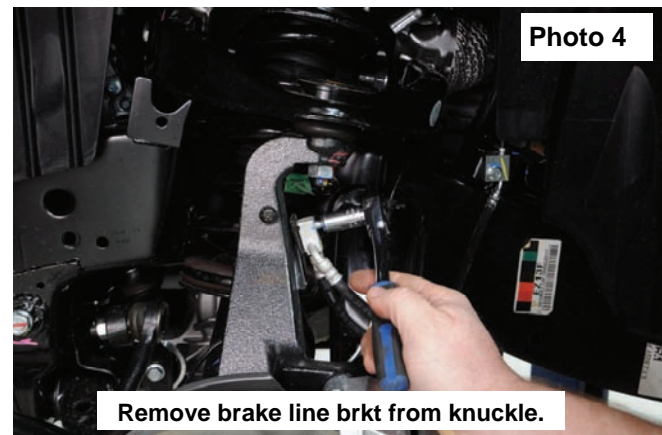

7. Using a 24mm wrench, remove the brake caliper bolts and save for reuse. Hang caliper out of the way. ****Do not let calipers hang by the brake line.**** Remove the brake rotor. **See Photo 5.**
8. Remove the cotter pin on the upper ball joint and use a 22mm wrench to loosen the ball joint nut. ****Do not remove the nut at this time.**** **See Photo 6.**

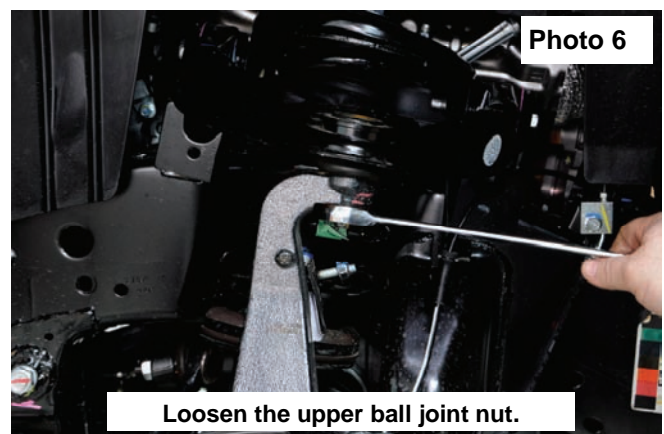
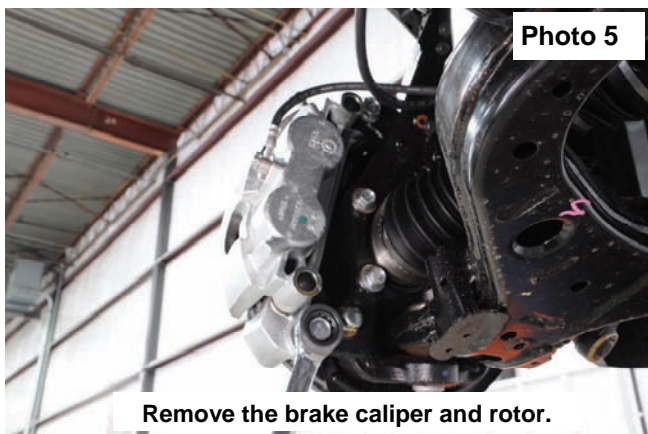

- Using a hammer, strike the knuckle at the upper ball joint to release the taper. **See Photo 7.**
- Remove the cotter pin from the axle shaft. Then, using a 32mm socket, remove the axle nut. **See Photo 8.**

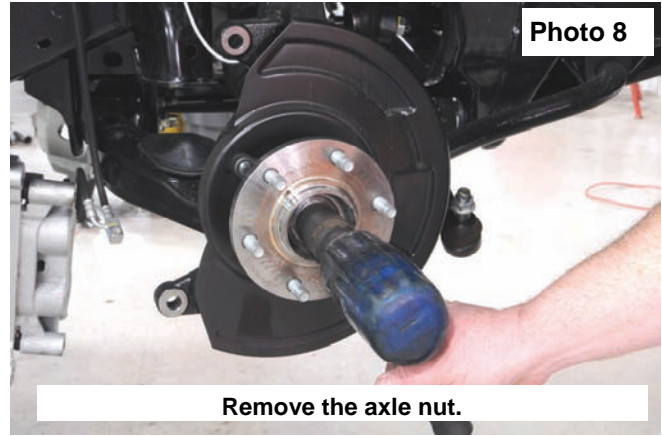
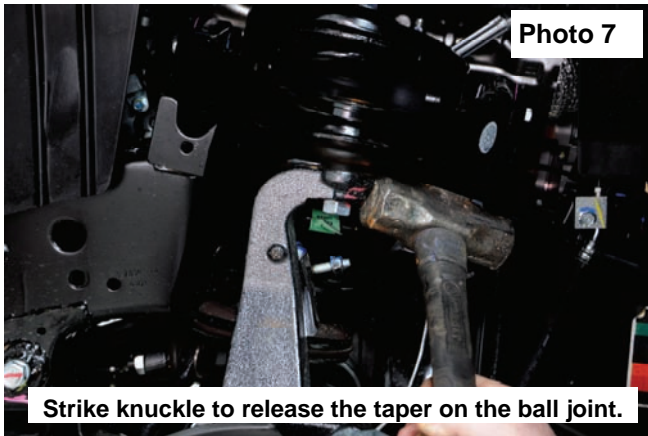

- Using a 5mm Allen wrench, remove the ABS sensor from the hub bearing assembly. **Photo 9.**
- Using a 24mm socket, loosen the nut securing the knuckle to the lower ball joint. **See Photo 10.**

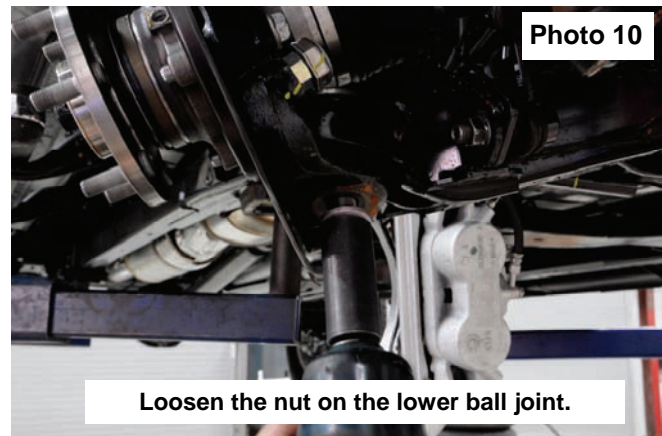
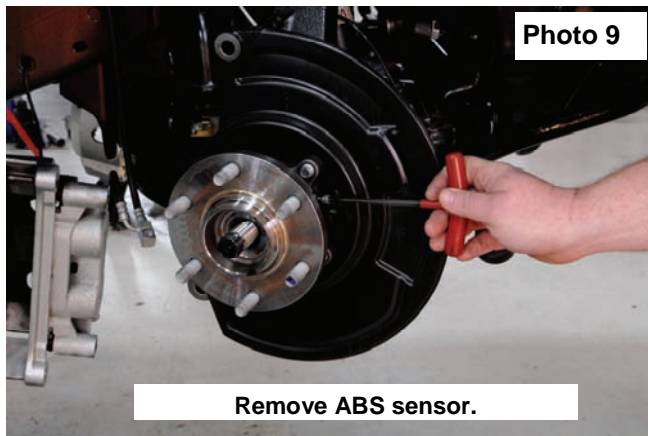

- Using a hammer, strike the knuckle at the lower ball joint to release the taper. **See Photo 11.** Remove the upper and lower ball joint nuts and remove the knuckle assembly from the vehicle.
- Using a 22mm socket and wrench, remove the lower strut hardware from the lower control arm. Save for reuse. **See Photo 12**

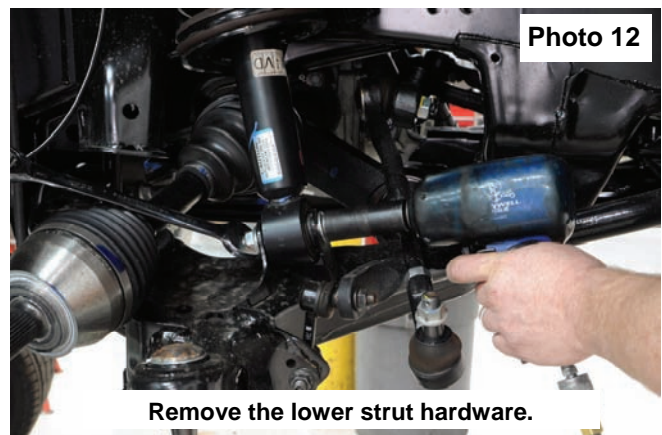

15. Support the lower control arm using a jack.
16. Using a 17mm wrench and 6mm Allen, remove the sway bar link from the lower control arm. **See Photo 13.**
17. Using a 14mm wrench, remove the upper strut hardware. **See Photo 14.** Retain stock hardware.
18. Remove the strut assembly from the vehicle.
19. Repeat process on opposite side.
20. Using a 24mm socket and 22mm wrench, remove the lower control arms. **See Photo 15.** Retain the stock hardware for reuse.
21. Using a 12mm socket, remove the lower skid plate. **See Photo 16.**
22. Using 21mm and 19mm wrenches, remove the rear crossmember. **See Photo 17.** Retain 1 nut for reuse when installing the differential.

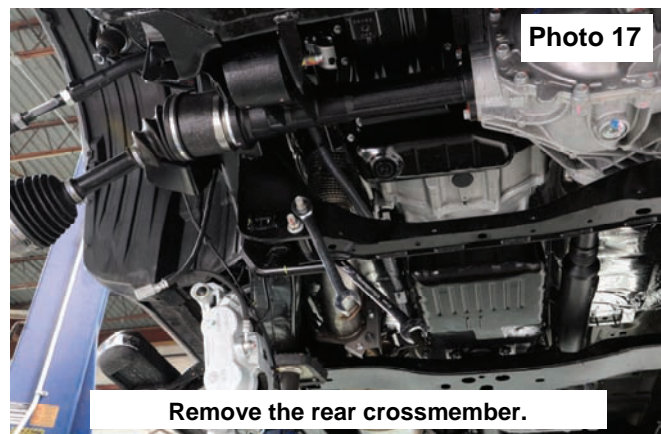
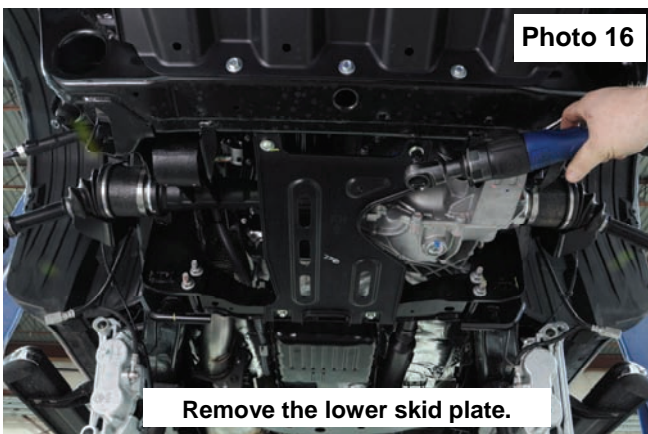
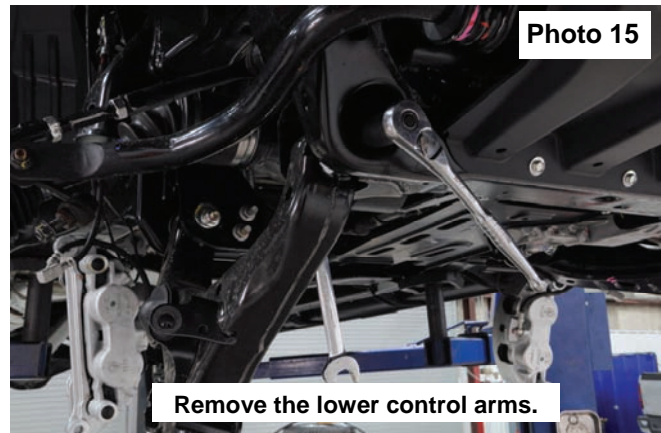
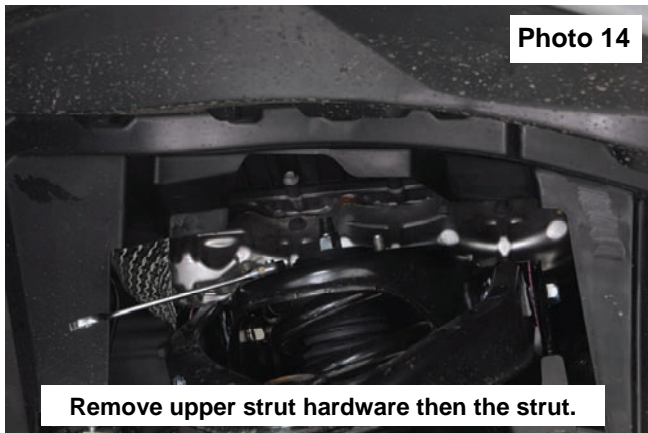
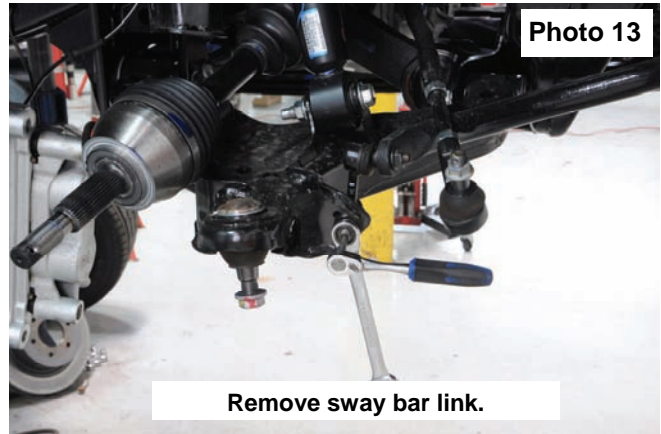

23. Mark the alignment of the front driveshaft and the front differential yoke. **See Photo 18.**
24. Using 17mm wrenches, remove the front driveshaft from the yoke. Support or tie the driveshaft out of the way. **See Photo 19.**

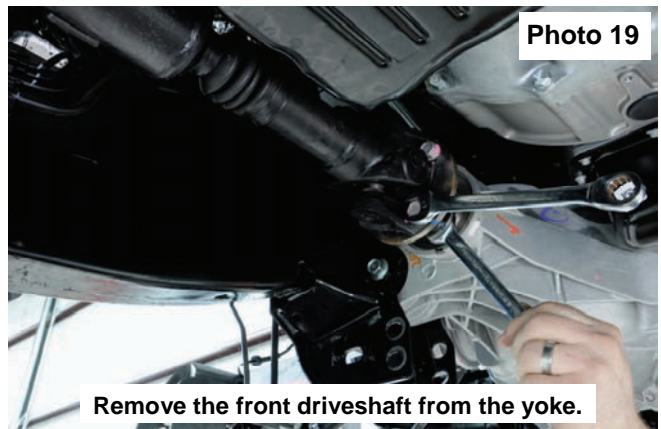
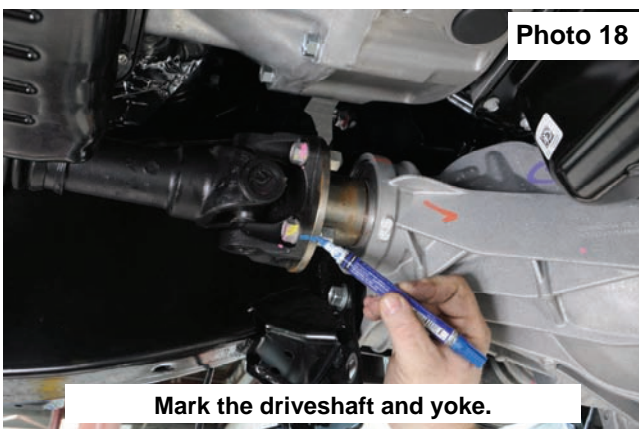

25. Locate and remove the differential vent hose. See Photos 20 & Photo 21.

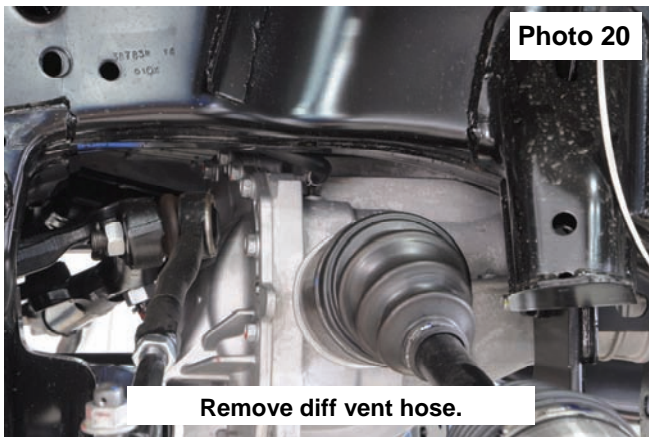

26. Support the front differential using a jack.

27. Using a 19mm socket and wrench, remove the 3 mounting bolts and hardware. Save for reuse. See Photos 22, 23, & 24.

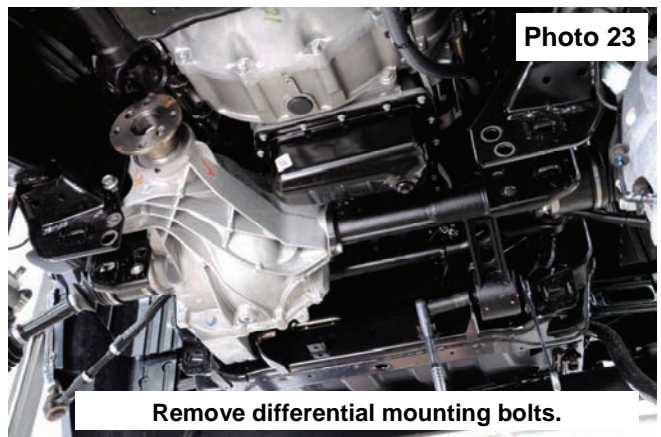
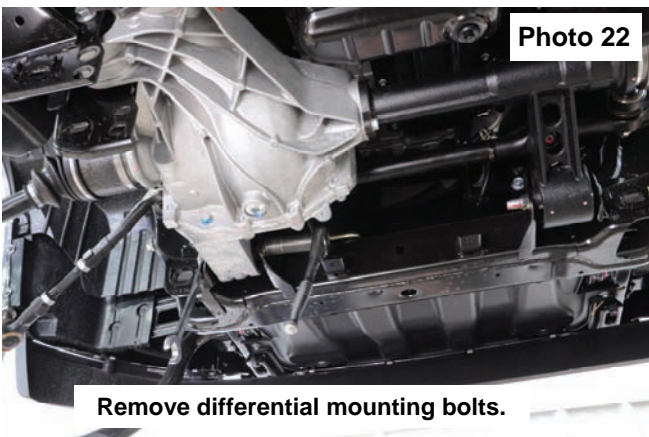

28. Remove the differential from the vehicle.

29. Use the supplied template to cut the front of the driver rear crossmember mount. Photo 25. Paint cut edges to prevent rust.

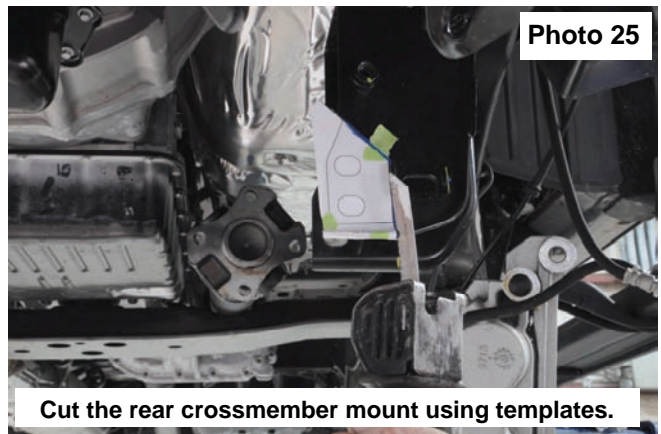
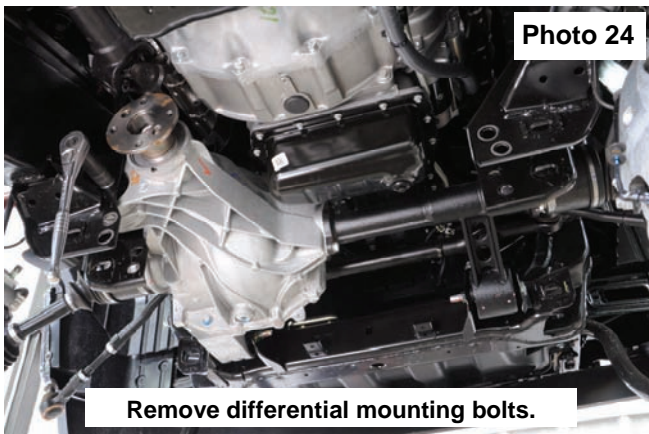

30. On the rear of the rear driver side crossmember mount, use the template and a 11/16" drill, to drill the new mounting hole. **See Photos 26 & 27.**



Photo 26

Drill hole using template.

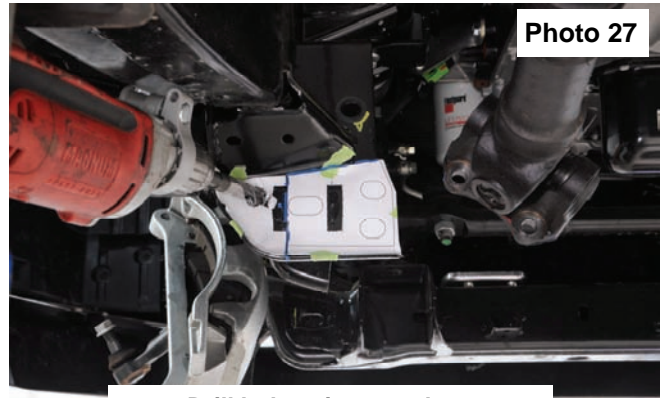

Photo 27

Drill hole using template.

31. Using the template, cut the rear of the driver side rear crossmember mount. **See Photo 28, 29, 30 & 31. Paint cut and drilled edges to prevent rust.**

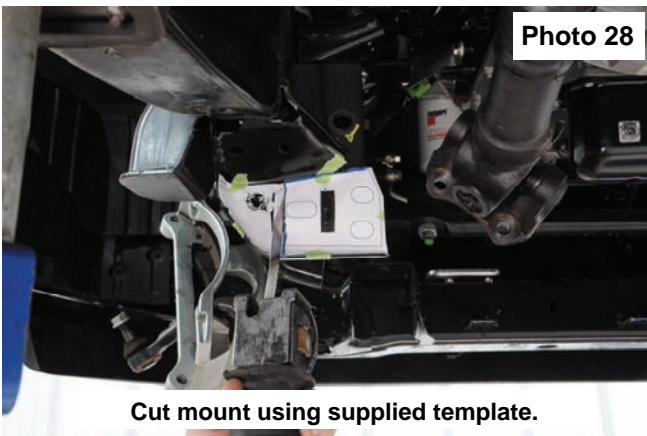

Photo 28

Cut mount using supplied template.

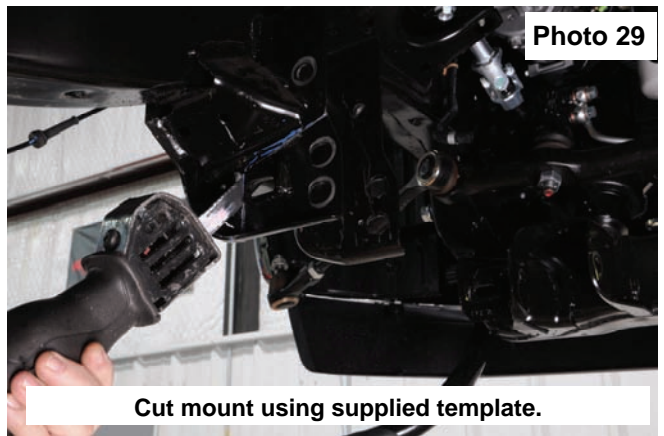

Photo 29

Cut mount using supplied template.

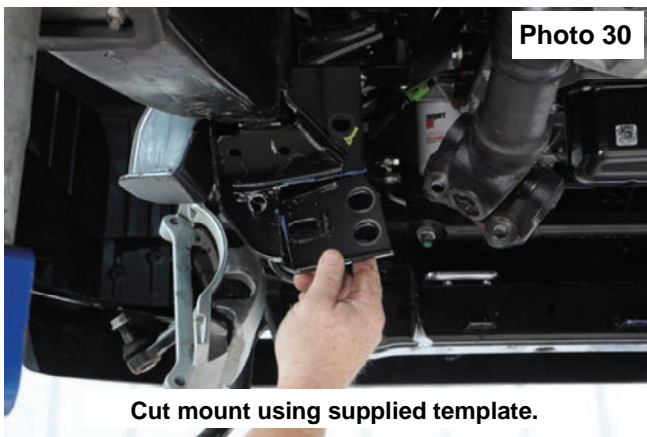

Photo 30

Cut mount using supplied template.

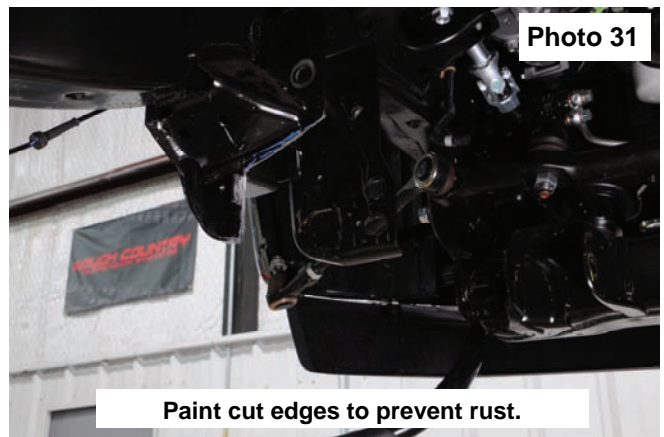

Photo 31

Paint cut edges to prevent rust.

32. Install the differential drop brackets on the front crossmember. Tighten using 5/8" wrenches. **See Photo 32.** Install the front crossmember using the supplied 5/8" x 5" bolts, washers and lock nuts from 1877BAG5. ****Do not tighten at this time.****
33. Install the differential into the mounts on the front crossmember using the factory hardware. **See Photo 33.** ****Do not tighten at this time.****



Install differential drop brackets on front crossmember.

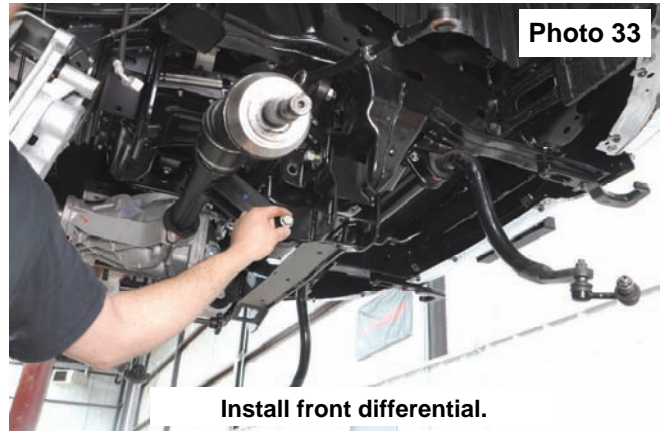

Install front differential.

34. Install the rear crossmember using the supplied 5/8" x 5" bolt, washer, and lock nut from 1877BAG5. Use the supplied 5/8" x 1.5" bolts, washers, and nuts from 1877BAG5 in the hole drilled in step 30. **See Photos 34 & 35.** ****Do not tighten at this time.****
35. Use the supplied 14mm x 35mm bolt and washer from 1877BAG5 in the top hole of the crossmember going into the diff. **See Photo 35.** ****Do not tighten at this time.****

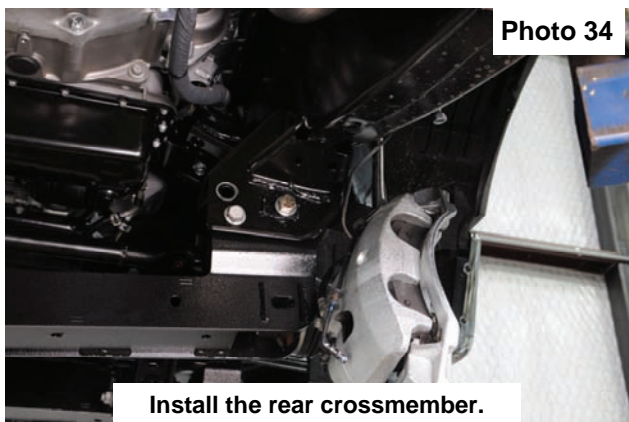

Install the rear crossmember.

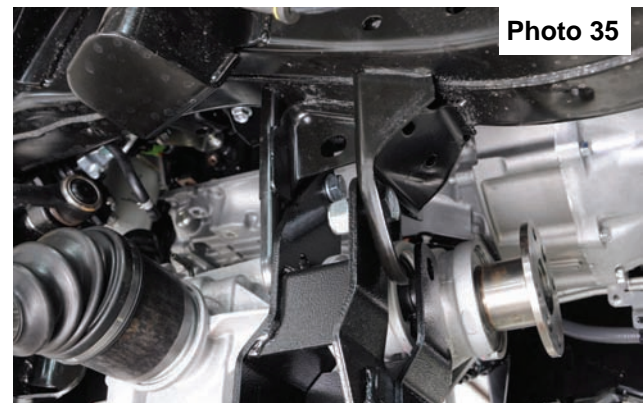

Bolt differential to the rear crossmember.

36. Use the factory bolt and nut, from step 22, to secure the rear diff mount to the crossmember. **See Photo 36.** ****Do not tighten at this time.****
37. Install the lower control arms using the stock hardware. **See Photo 37.**



Bolt rear crossmember to differential.

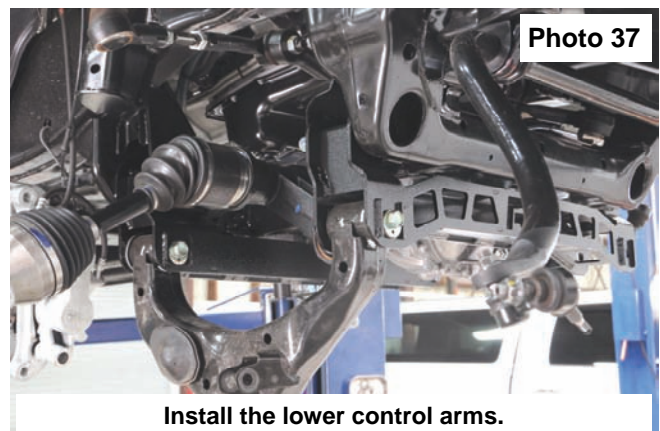

Install the lower control arms.

38. Install the driveshaft on the yoke making sure to align marks and using the factory hardware. Torque to factory specs. **See Photo 38.**
39. Install supplied 1/4" vent hose extension from 1877BAG3. **See Photo 39.**
40. Torque all differential and crossmember mounting bolts to factory specs.

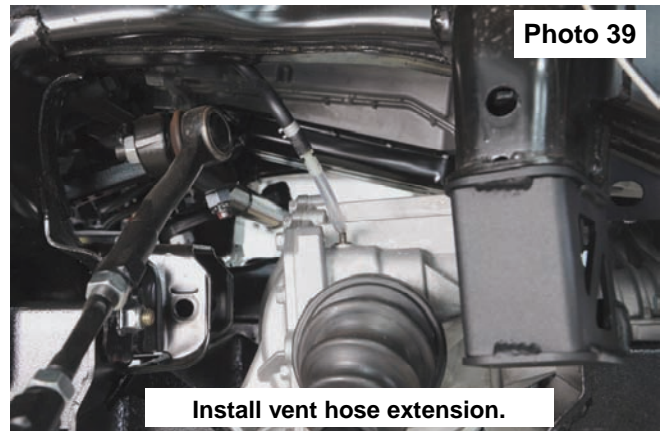
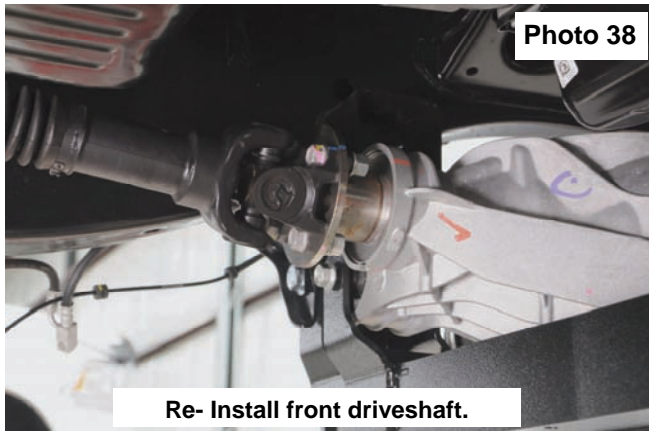

41. Place the bump stop template on the bottom of the bump stop. **See Photo 40.**
42. Using a 13/32" drill, drill a hole in the bottom of the factory bump stop. **See Photo 41.** Paint the drilled area.

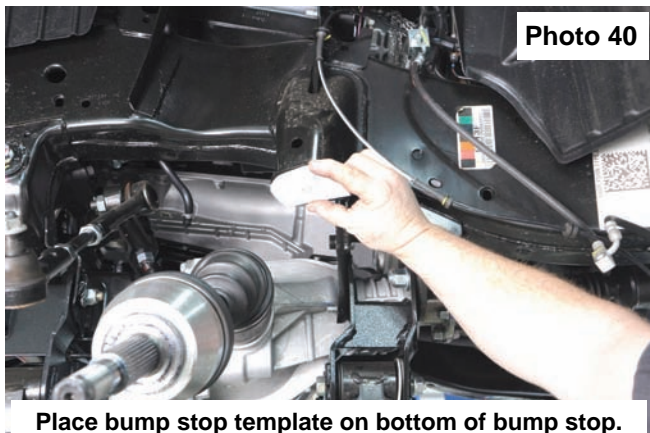

43. Drill the hole on the side of the factory bump stop mount to 3/4". **See Photo 42.** Paint the drilled area.
44. Place the supplied flag nut inside of the factory bump stop mount, through the 3/4" hole. **See Photo 43.**



45. Install the supplied bump stop extension using the supplied 3/8" x 1.25" bolts and washers from 1877BAG3 See **Photo 44**. Tighten using a 9/16" wrench.
46. Install the supplied 10mm studs into the strut spacers. See **Photo 45**.

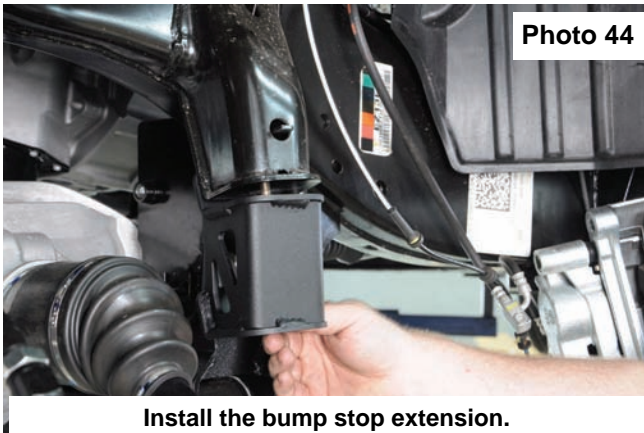

Install the bump stop extension.



Install the 10mm studs in the strut spacer.

47. Install strut spacers on the stock strut with shorter side to the back closest to the frame rail. See **Photo 46**. Driver side has a "D" and the pass. side has a "P" on the top plate.
48. Install the strut assembly on truck using the supplied 10mm nuts & lock washers on the upper strut spacer and stock hardware in lower control arm strut mount as shown in **See Photos 47 & 48**. Tighten the upper hardware using a 17mm wrench and the lower using a 22mm socket and wrench. Torque to factory specs.

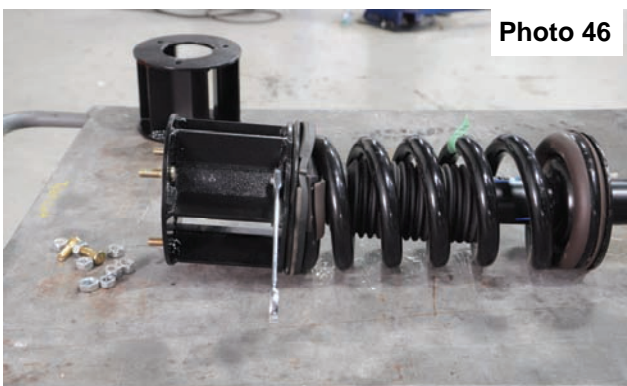

Install strut spacer with the shorter side toward the frame.

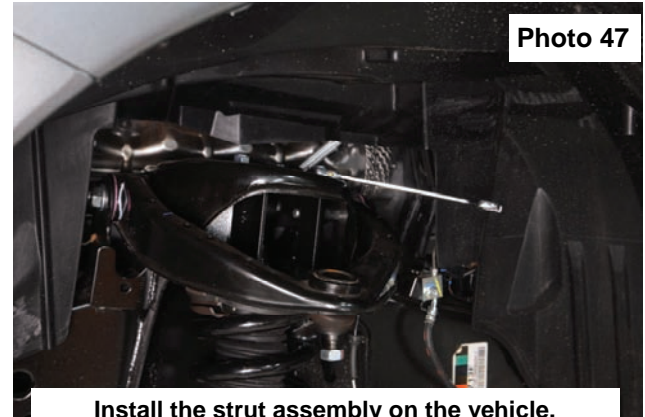

Install the strut assembly on the vehicle.

49. Using a 17mm wrench and a 6mm Allen, remove the sway bar link from the sway bar. See **Photo 49**.

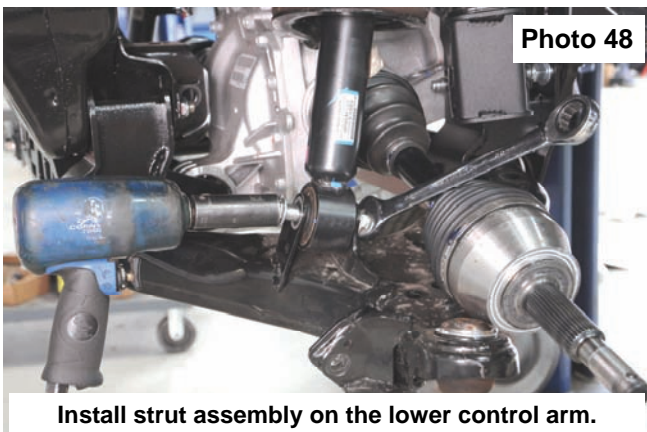

Install strut assembly on the lower control arm.

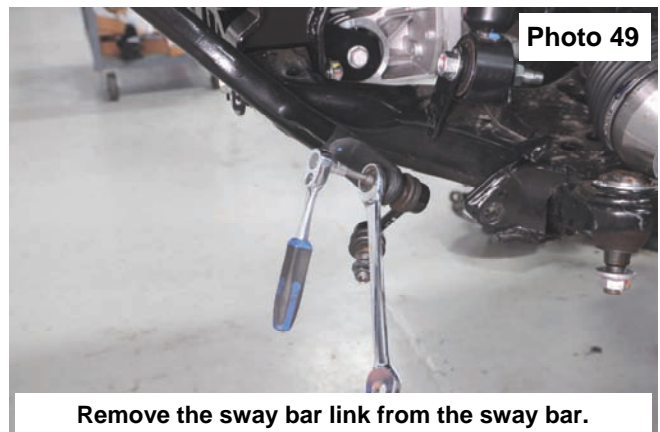

Remove the sway bar link from the sway bar.

50. Using a 22mm wrench, remove the steering stops from the factory knuckle. **See Photo 50.**

51. Install the steering stops on the new Rough Country lifted knuckle. **See Photo 51.**



52. Using a 19mm socket, remove the bearing assembly from the factory knuckle and install in the lifted knuckle. Install the ABS/ brake line bracket on the knuckle using the supplied self tapping 5/16" bolts from 1877BAG3 **See Photo 52.**

53. Install the new assembled knuckle on the vehicle using the stock hardware. Torque to factory specs. **See Photo 53.**



54. Install the supplied sway bar links on the sway bar and lower control arm using the supplied 12mm x 65mm bolts and hardware. Tighten using 18mm and 19mm wrenches. **See Photo 54.**

▲ NOTICE Do not over tighten, over tightening can crush the sleeve resulting in premature bushing failure.

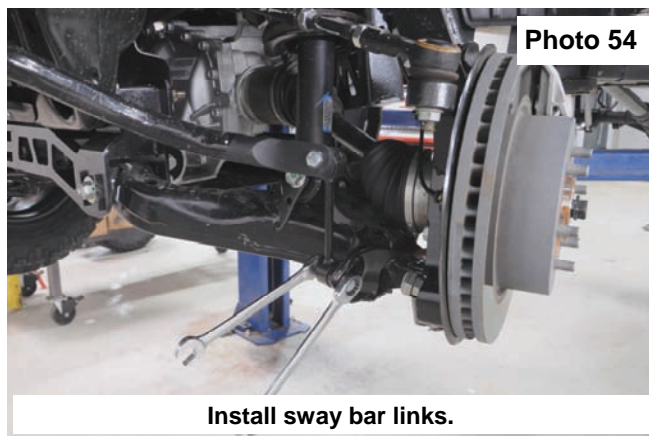

55. Install the ABS wire using a 5mm Allen. **See Photo 55.**

56. Install the axle nut using a 32mm socket. Torque to factory specs. **See Photo 56.**

57. Attach the brake line to the bracket using the supplied 5/16" x 1.25" bolts, nuts, and washers in 1877BAG3.

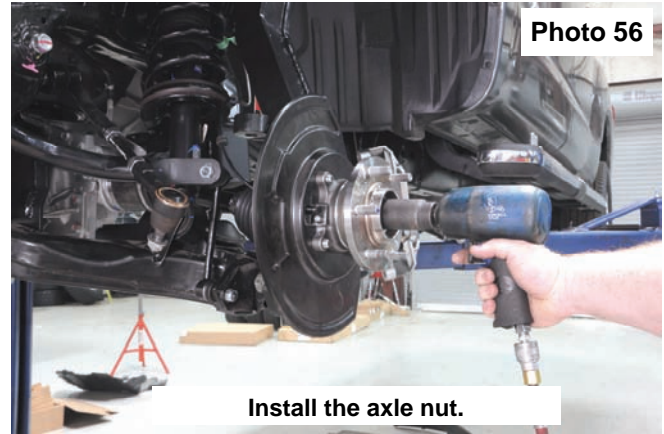
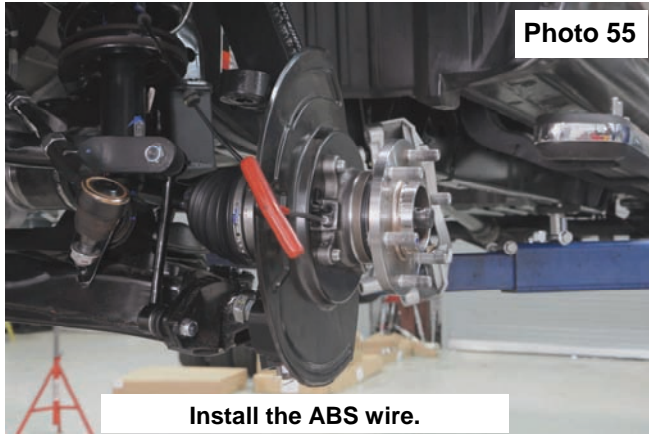

58. Install the brake rotor and brake caliper using a 24mm socket. Torque to factory specs. **See Photo 57.**

59. Using a 14mm and 24mm wrench loosen the tie-rod end and turn it 180° **See Photo 58.**

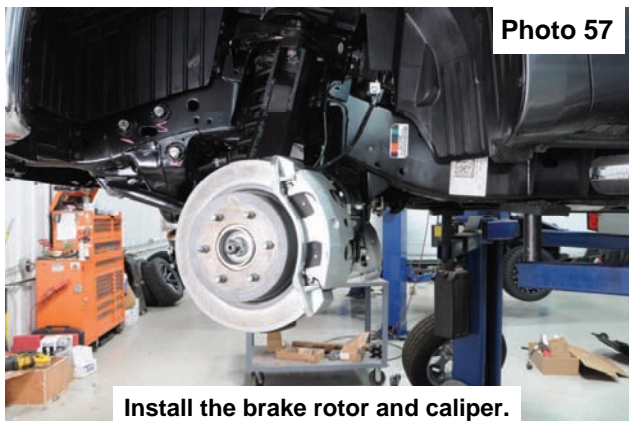

60. Install the tie rod on the knuckle using a 22mm wrench. Torque to factory specs. **See Photo 59.**

61. Install the new skid plate using the supplied 3/8" x 1.25" bolts and washers from 1877BAG4. Tighten using a 9/16" socket. **See Photo 60.**

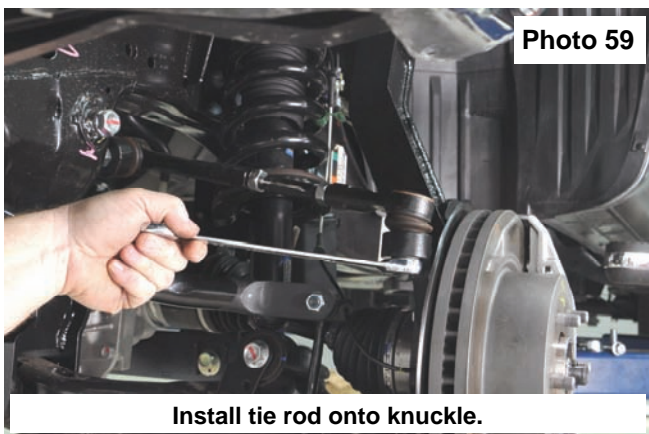

62. Install the wheels and tires and lower the vehicle to the ground.

63. Tighten the lower control arm cam bolts using 24mm and 22mm wrenches.

Rear Installation Instructions

1. Chock the front tires and lift the rear of the vehicle, position jack stands under the rear frame rails of the vehicle and lower the vehicle on to the jack stands.
2. Place a floor jack in position under the rear differential for support.
3. Remove the lower shock bolts using 19mm and 21mm wrenches. Save for reuse. **See Photo 1.**
4. Remove the sway bar links using a 18mm wrench and 6mm Allen. **See Photo 2.**

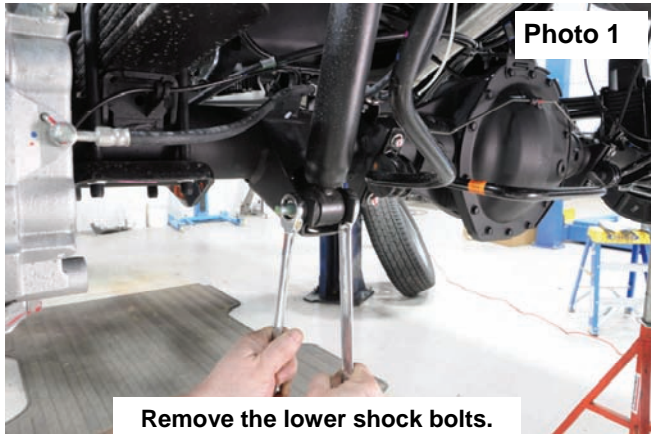

5. Remove the upper shock bolts using 21mm and 19mm wrenches. Save for reuse. **See Photo 3.**
6. Using a 10mm wrench, remove the brake line shield. **See Photo 4.**

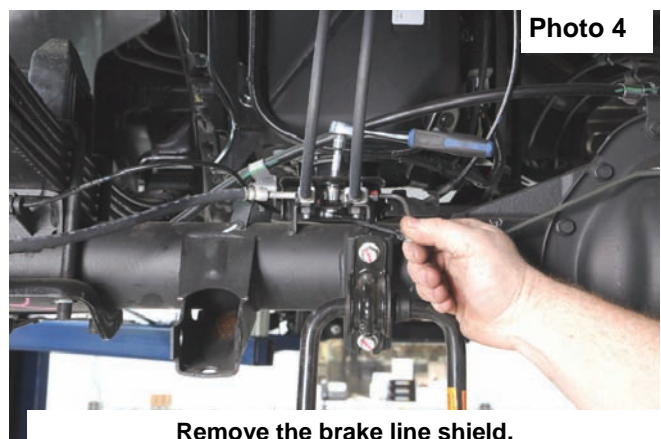
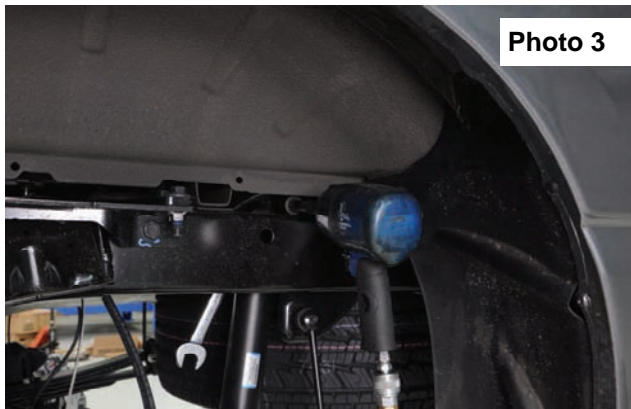

7. Remove the brake line shield. **See Photo 5.**
8. Using a 12mm socket, remove the brake lines from the axle bracket. **See Photo 6.**

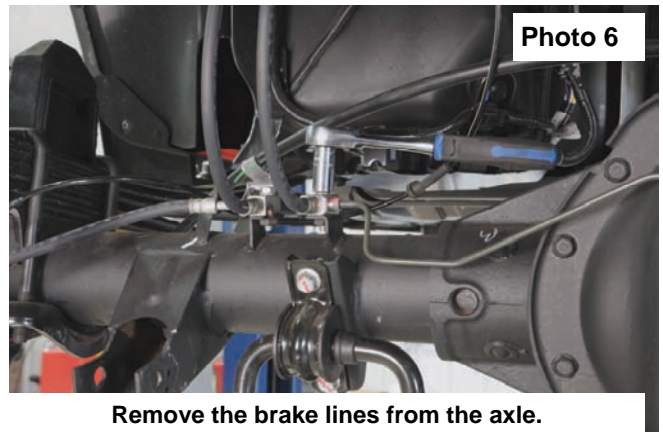
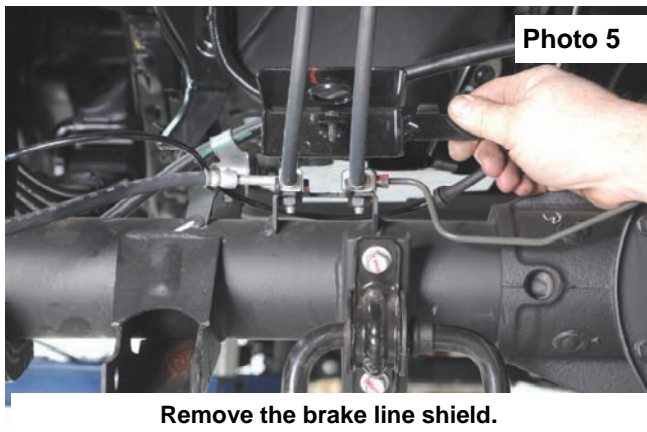

9. Install the brake line bracket using the supplied 8mm x 15mm bolts and washers. Tighten using a 13mm wrench. Attach the brake lines to the bracket using the supplied 5/16" x 1.25" bolts, washers and nuts. Tighten using 1/2" wrenches. **See Photo 7.**
10. Install the emergency brake line bracket using the factory hardware. Tighten using a 12mm wrench. Attach the emergency brake cable using the supplied 5/16" x 1" bolts, washers and nuts. Tighten using 1/2" wrenches. **See Photo 8.**

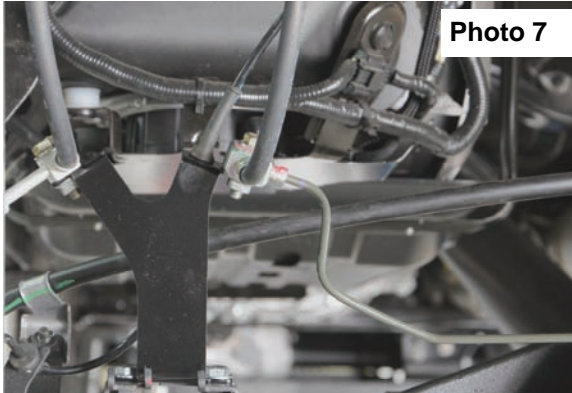

Install the brake line relocation bracket.

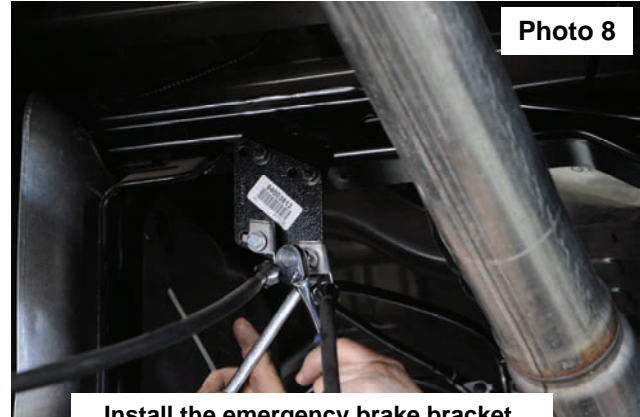

Install the emergency brake bracket.

11. Install the supplied 3/16" vent tube extension from 1877BAG3. **See Photo 9.**
12. Remove the factory u bolts using a 19mm socket. Lower the axle away from the springs. **See Photo 10.**

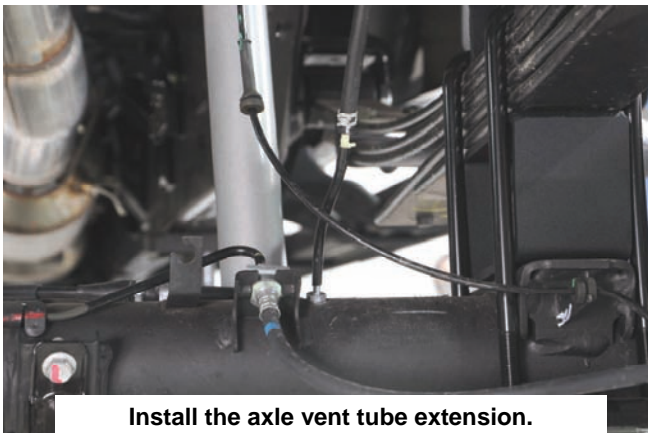

Install the axle vent tube extension.



Remove the factory u bolts and hardware.

13. Install the shock (660794) in the upper mount using the factory hardware. Body of the shock goes down. **See Photo 11.**
14. Install the new lift block with the taller end of the block to the rear of the vehicle. Make sure the center pin is seated in the axle perch. Install the 7/16" u-bolts and 7/16" hardware, do not tighten at this time. **See Photo 12.**



Install rear shocks in the upper mount.

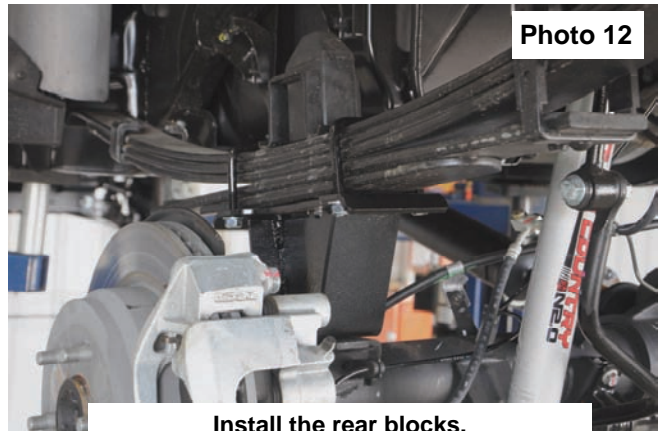

Install the rear blocks.

15. Install the supplied the supplied 9/16" u-bolts, washers, and nuts. **See Photo 13.**
16. Tighten u-bolt nuts using a 13/16" socket. Torque to 90ft-lbs. **See Photo 14.**

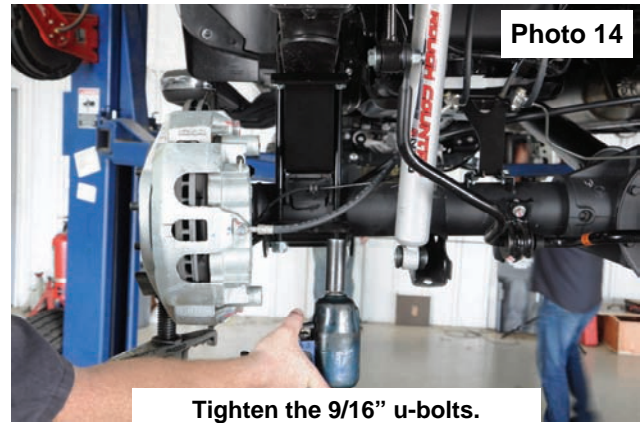
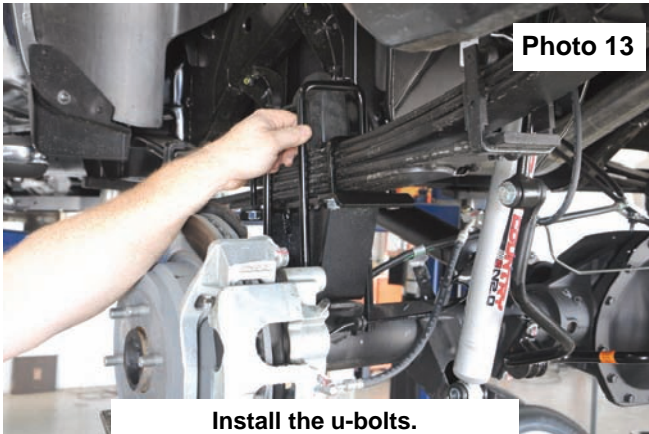

17. Tighten the 7/16" u-bolts using a 5/8" socket, torque to 45ft-lbs. **See Photo 15.**
18. Install the new sway bar links using the supplied 12mm x 65mm bolts, washers, and nuts(1877BAG3) and the sleeves in 1698BAG3. **See Photo 16.**

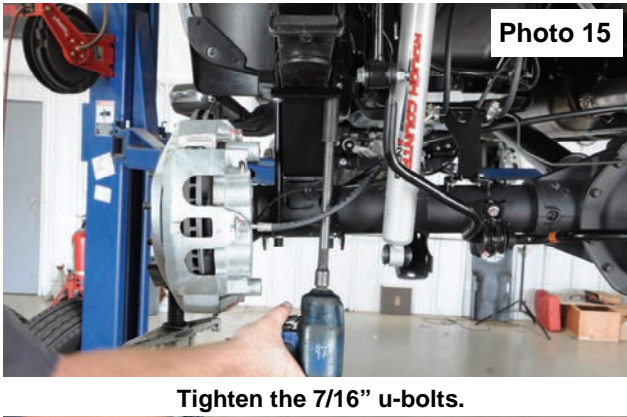

19. Tighten the sway bar links using 18mm and 19mm wrenches. **See Photo 17.**
20. Install the shock into the lower mount using the factory hardware. Torque the upper and lower bolts, using 19mm and 21mm wrenches, to factory specs. **See Photo 18.**

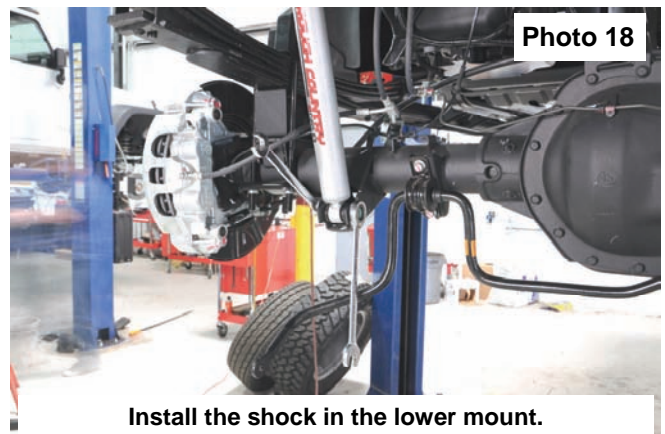

21. Using a 14mm socket, drop the carrier bearing down, making sure to support the driveshaft. **See Photo 19.**
22. Install 2 of the shims between the carrier bearing and the crossmember. **See Photo 20.**

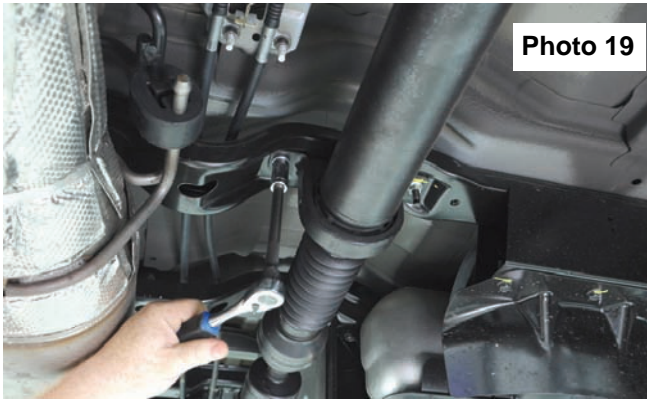

Lower the carrier bearing.



Install carrier bearing shims.

23. Using the factory hardware, install the carrier bearing on the factory studs. Tighten using a 14mm socket. Torque to factory specs. **See Photo 21.**
24. Diesel models skip to the next page.
25. Gas models will need to install the transmission shim to keep the front driveshaft from making contact with the crossmember.
26. Using a 17mm socket, remove the transmission mounting nuts. **See Photo 22.**
27. Using a jack, lift the transmission and install the shim, from the front, in between the crossmember and the transmission mount. **See Photo 23.**
28. Lower the transmission and install the factory nuts with a 17mm socket. Torque to factory specs.

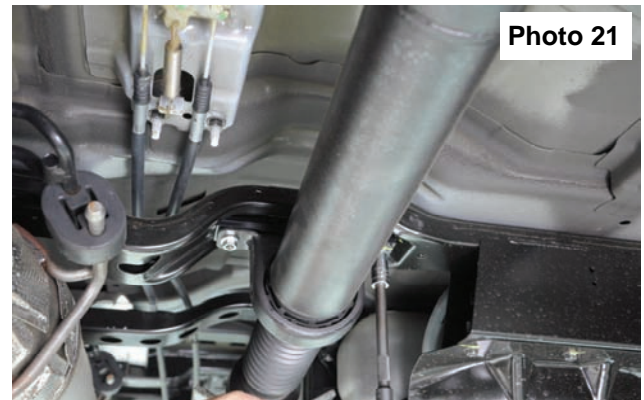

Tighten carrier bearing bracket.



Remove transmission mount nuts.

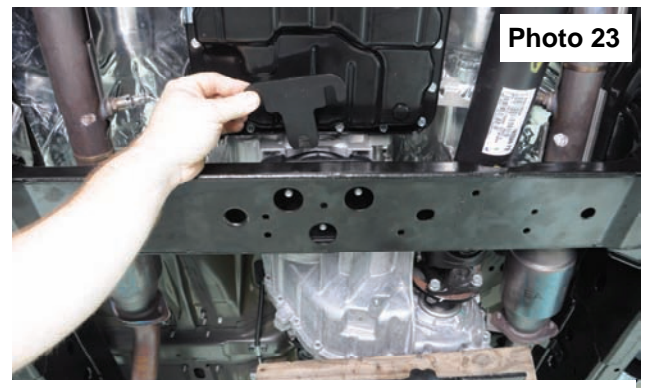

Install transmission shim.

Front bumper spacers.

1. Using a flat screwdriver, pry the parking sensor bezels out of the 4 clips (each side). **See Photo 1.**
2. Unplug the parking sensors. **See Photo 2.**



3. Using a 17mm socket, remove the tow hooks. **See Photo 3.**
4. Using a 10mm socket, remove the plastic pieces above the tow hooks. **See Photo 4.**



5. Remove the plastic pieces from above the tow hooks. **See Photo 5.**
6. Unplug the fog lights. **See Photo 6.**

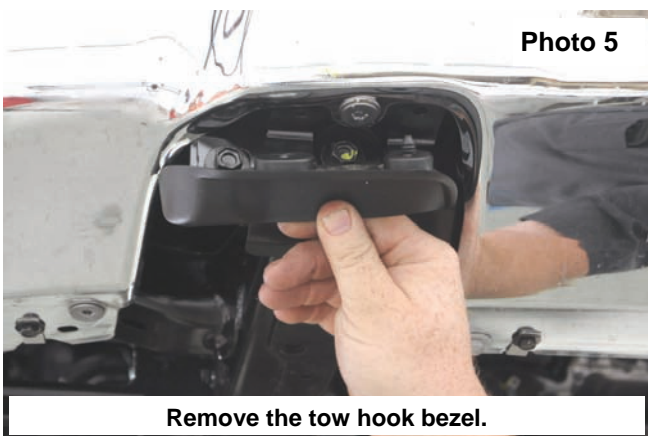

7. Mark the bumper mounting bolts for a reference when reinstalling. **See Photo 7.**
8. Using a 12mm socket, remove the side bumper bracket bolts. Save for reuse. **See Photo 8.**

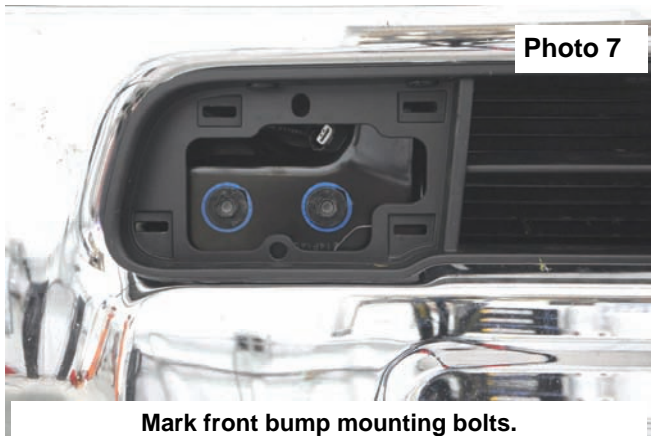

Mark front bumper mounting bolts.

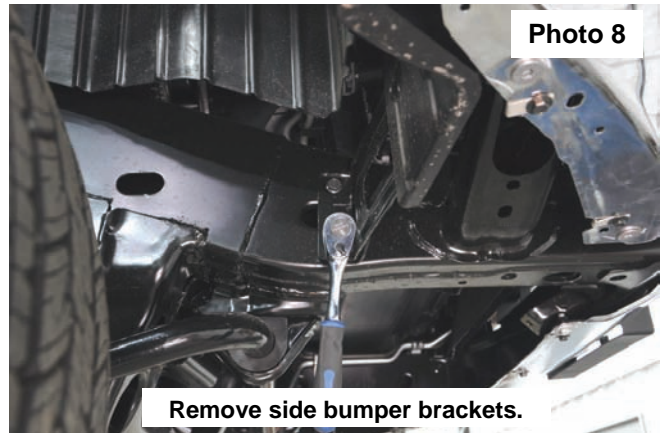

Remove side bumper brackets.

9. Using a 14mm socket, remove the 2 bolts (1 per side) on the bottom of the frame, securing the bumper. **See Photo 9.**
10. Using a 14mm socket, remove the 8 bolts holding the bumper to the frame on the front of the truck. **See Photo 10.**

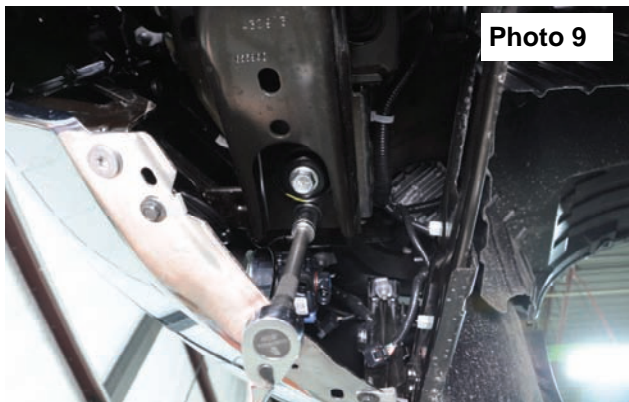

Remove the lower bumper mounting bolts.



Remove the front bumper mounting bolts.

11. Remove the bumper from the truck.
12. Remove the 2 flat bumper brackets using a 14mm socket. **See Photo 11.**
13. Install the L-shaped bumper spacers on the flat bumper brackets along with the supplied 10mm x 35mm bolts and washers (1877BAG3). **See Photo 12.**

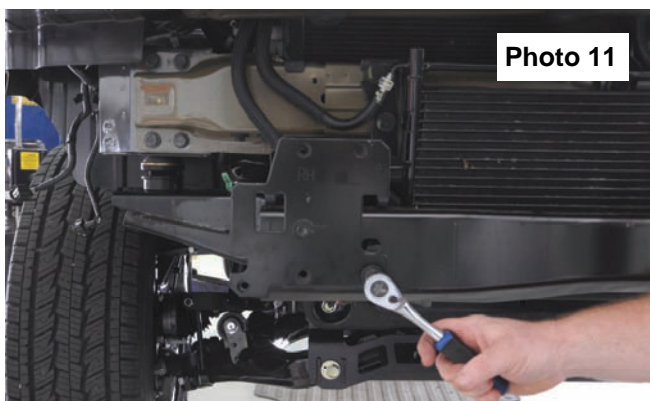

Remove the front bumper mounting plates.

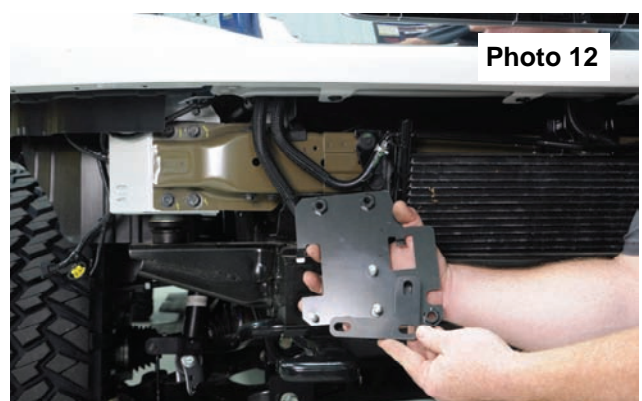

Install the bumper shims.

14. Place bumper spacer on flat bumper brackets. **See Photo 13.**
15. Install on bumper mount and tighten using 17mm socket. Torque to 35ft-lbs. **See Photo 14.**

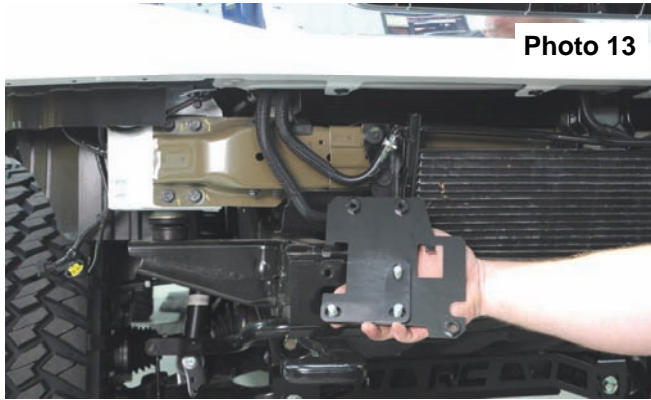

Photo 13

Install bumper shims and hardware.

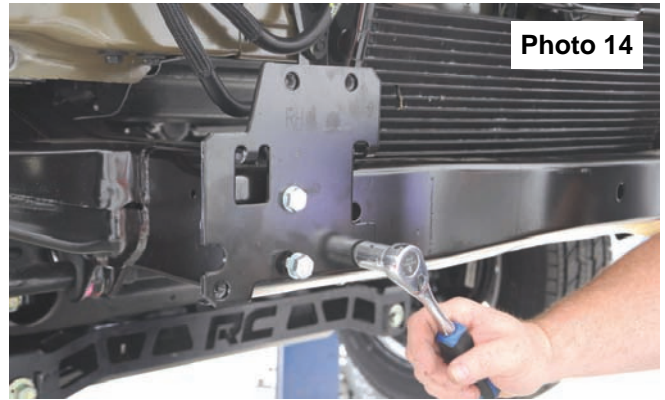

Photo 14

Install mounting plates on frame.

17. On the body mount hole, measure 1/4" from the front side of the hole, towards the front of the truck. Mark this spot to drill. **See Photo 15.**
18. Drill or slot hole to factory hole size. Paint the area to prevent rust. **See Photo 16.**

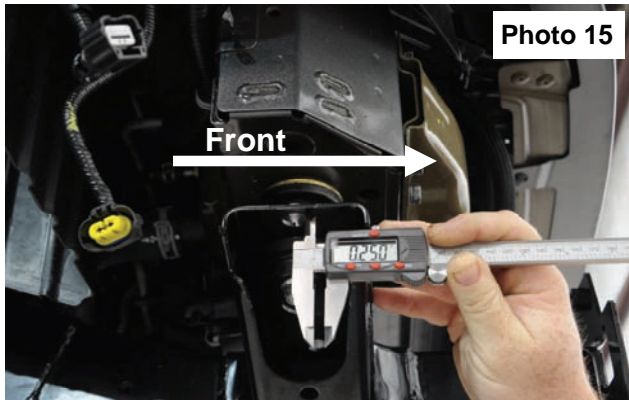

Photo 15

Measure 1/4" to the front of truck and mark.

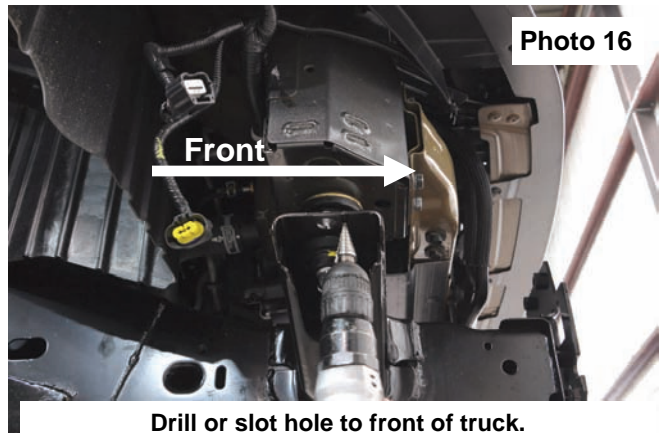
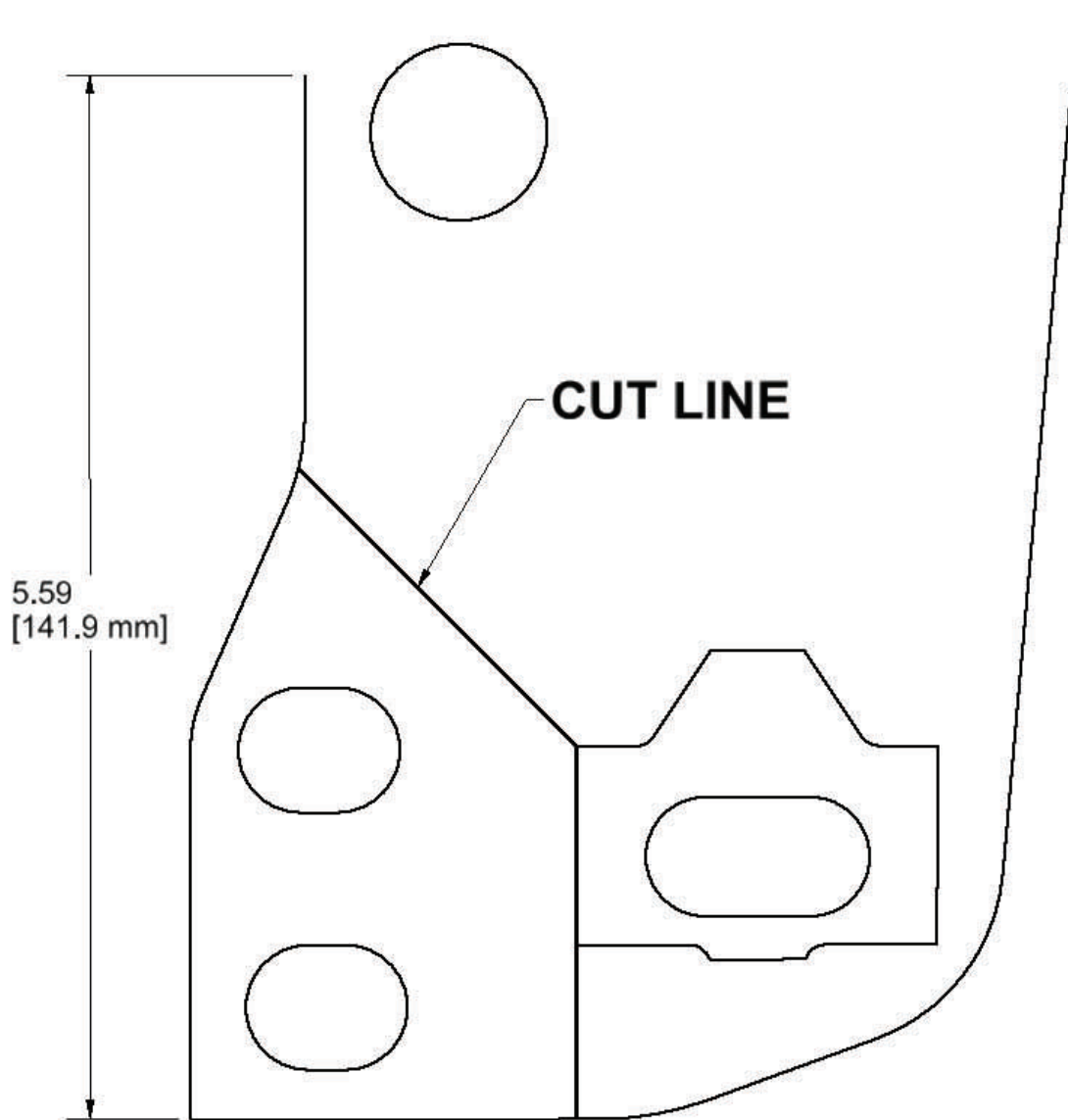

Photo 16

Drill or slot hole to front of truck.

19. Install the bumper and tow hooks using the stock hardware. Plug in fog lights and parking sensors.

Front of Driver Side Rear Crossmember Template



Bump Stop Drill Templates

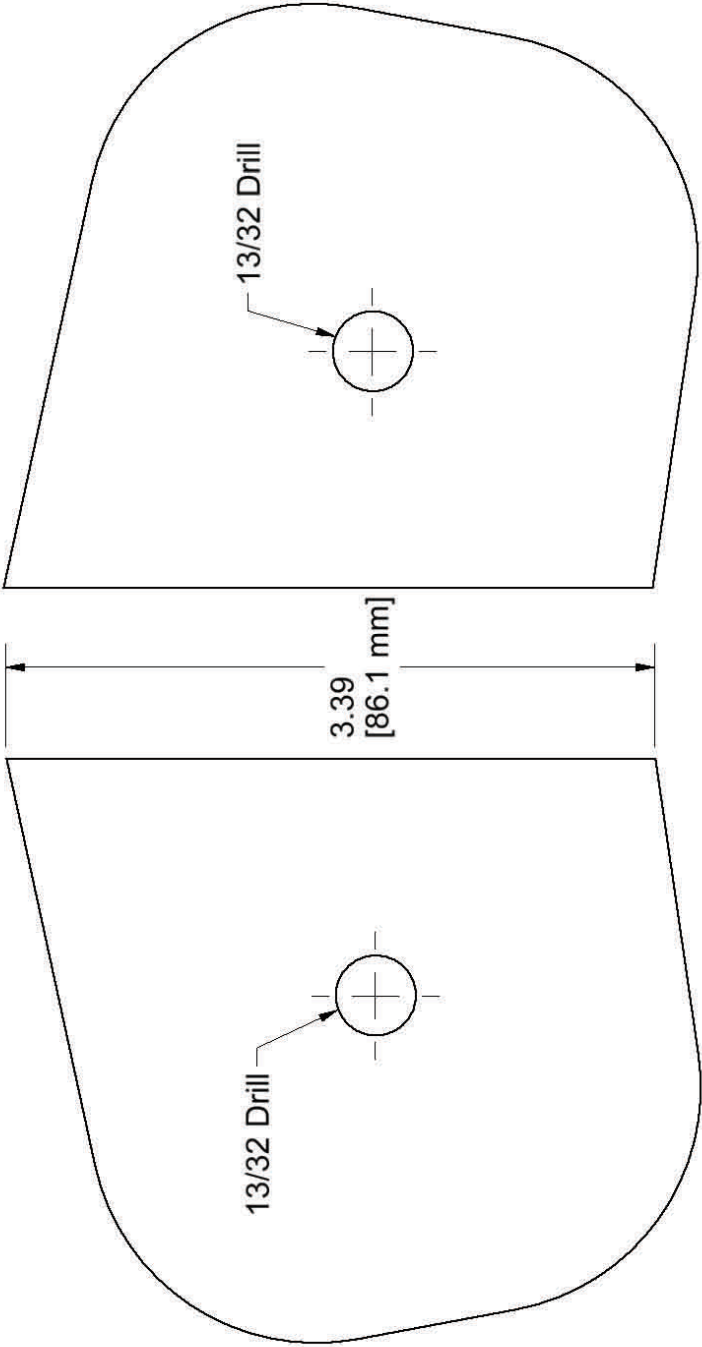

Rear of Driver Side Rear Crossmember Template

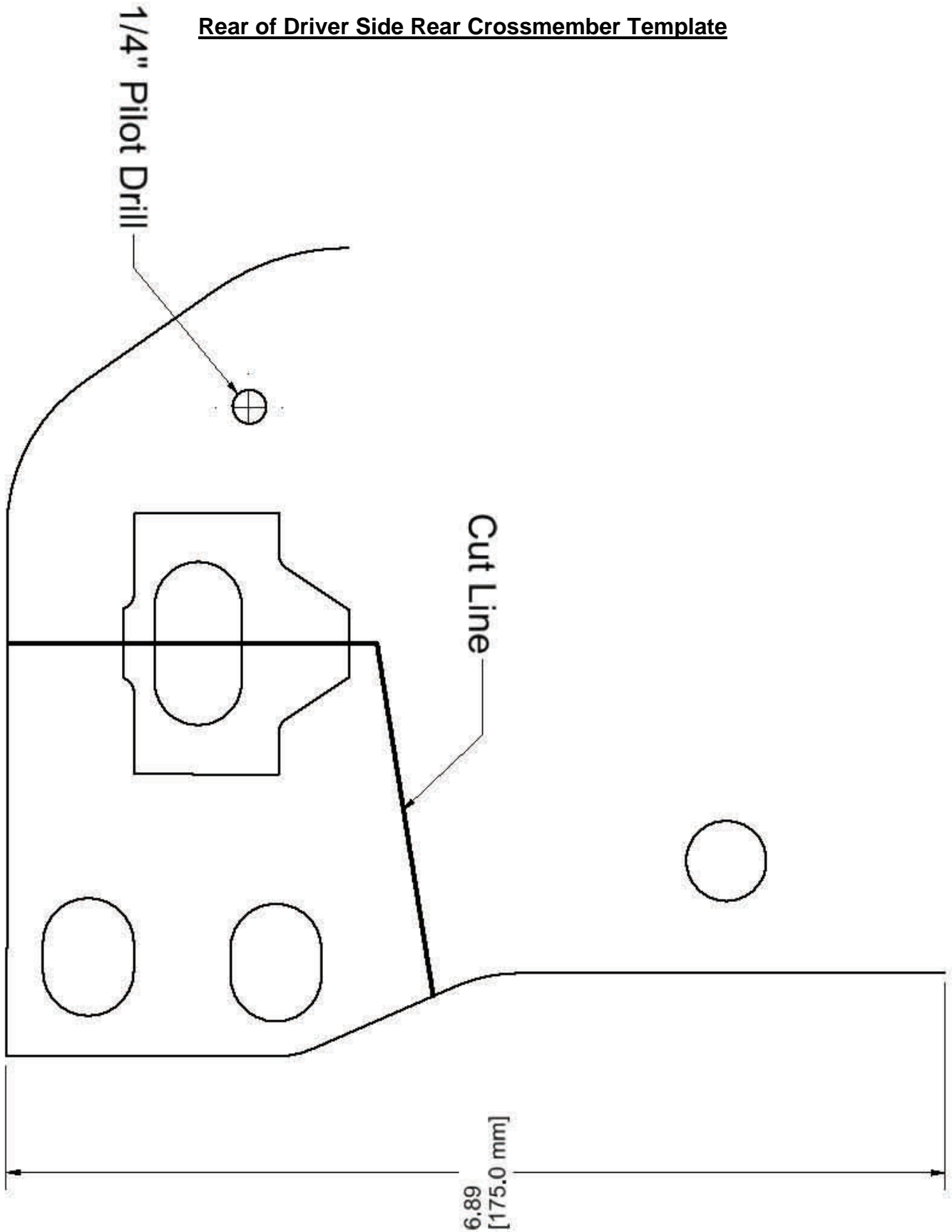

By purchasing any item sold by Rough Country, LLC, the buyer expressly warrants that he/she is in compliance with all applicable , State, and Local laws and regulations regarding the purchase, ownership, and use of the item. It shall be the buyers responsibility to comply with all Federal, State and Local laws governing the sales of any items listed, illustrated or sold. The buyer expressly agrees to indemnify and hold harmless Rough Country, LLC for all claims resulting directly or indirectly from the purchase, ownership, or use of the items.



