



## #J9230 Installation Instructions 72-86 Jeep CJ5, CJ7 2" Body Lift

### Read and understand all instructions and warnings prior to installation of product and operation of vehicle.

Zone Offroad Products recommends this system be installed by a professional technician. In addition to these instructions, professional knowledge of disassembly/ reassembly procedures and post installation checks must be known. Minimum tool requirements include the following: Assorted metric and standard wrenches, hammer, hydraulic floor jack and a set of jack stands. See the "Special Tools Required" section for additional tools needed to complete this installation properly and safely.

#### » PRODUCT SAFETY WARNING

Certain Zone Suspension Products are intended to improve off-road performance. Modifying your vehicle for off-road use may result in the vehicle handling differently than a factory equipped vehicle. Extreme care must be used to prevent loss of control or vehicle rollover. Failure to drive your modified vehicle safely may result in serious injury or death. Zone Offroad Products does not recommend the combined use of suspension lifts, body lifts, or other lifting devices.

You should never operate your modified vehicle under the influence of alcohol or drugs. Always drive your modified vehicle at reduced speeds to ensure your ability to control your vehicle under all driving conditions. Always wear your seat belt.

#### » TECHNICAL SUPPORT

*Live Chat* provides instant communication with Zone tech support. Anyone can access live chat through a link on [www.zoneoffroad.com](http://www.zoneoffroad.com).

[www.zoneoffroad.com](http://www.zoneoffroad.com) may have additional information about this product including the latest instructions, videos, photos, etc.

Send an e-mail to [tech@zoneoffroad.com](mailto:tech@zoneoffroad.com) detailing your issue for a quick response.

**888-998-ZONE** Call to speak directly with Zone tech support.

#### » PRE-INSTALLATION NOTES

1. Special literature required: OE Service Manual for model/year of vehicle. Refer to manual for proper disassembly/reassembly procedures of OE and related components.
2. Adhere to recommendations when replacement fasteners, retainers and keepers are called out in the OE manual.
3. Larger rim and tire combinations may increase leverage on suspension, steering, and related components. When selecting combinations larger than OE, consider the additional stress you could be inducing on the OE and related components.
4. Secure and properly block vehicle prior to installation of Zone Offroad Products. Always wear safety glasses when using power tools.
5. Zone Offroad Products body lifts are designed to be used on vehicles in good operating condition. It is not recommended that body lifts be used on vehicles in poor physical shape. This includes rusted body mounts, damaged or worn frame-to-body mounting brackets, and poor mechanical condition. Perform a visual inspection of the vehicle before beginning installation.

#### Difficulty Level

easy 1 2 3 4 5 difficult

Estimated installation: 4-5 hours

#### Special Tools Required

Welder

#### Tire/Wheel Fitment

32x11.50 Tire/15x8, 3.5" BS  
Wheel

## Kit Contents

Qty	Part
1	Bolt Pack
1	Clutch Linkage Bracket
1	.750" x .120" x 3.00" Sleeve
4	2" wide x 2" tall Body Lift Block
1	3" wide x 1-13/16" tall Body Block
8	3" wide x 2" tall Body Lift Block
2	1/8" x 3/4" Roll Pin
1	Loctite

## HARDWARE PACK

Qty	Description
8	3/8"-16 x 4-1/2" bolt
8	3/8" USS flat washer
5	7/16"-14 x 4-1/2" bolt
5	7/16" USS flat washer
1	5/16"-18 x 1-1/4" bolt
2	5/16"-18 prevailing torque nut
3	5/16" USS washer
2	1/16" x 1" cotter pin

## Installation Instructions

1. Separate out shortest lift block from the remaining 12, this lift block will be used in combination with a bracket to achieve proper lift. It is approximately 3/16" shorter.
2. Block wheels for safety.
3. Disconnect battery.
4. Disconnect clutch linkage inside of cab as shown – Fig 1.

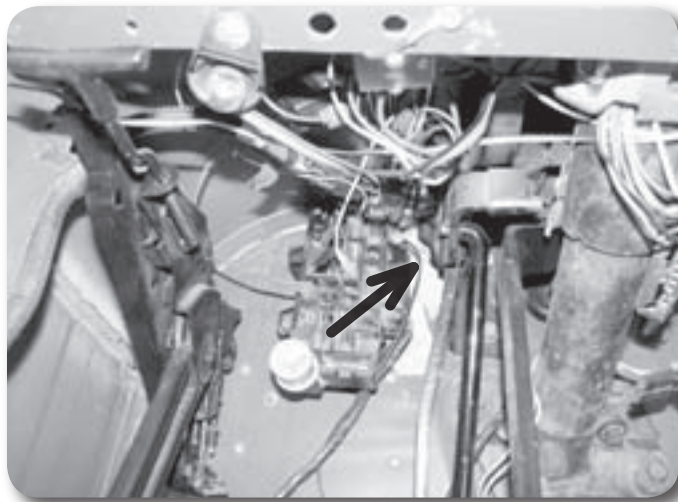

Figure 1

5. Remove opposite end of clutch linkage under hood as shown – Fig 2.



Figure 2

6. Remove and retain nuts holding clutch linkage bracket to firewall – Fig 3.

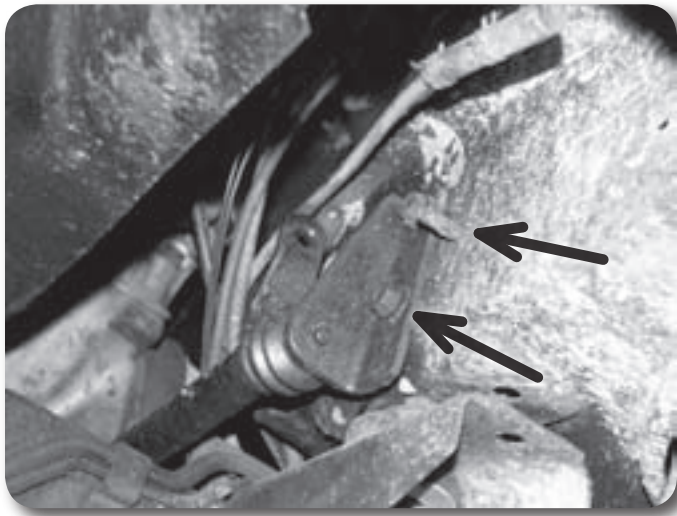

Figure 3

7. Remove linkage from vehicle and save for modification.
8. Mark steering shaft alignment at both mounting locations. These marks will ensure that the shaft is reinstalled in the correct orientation.
9. Remove and retain hardware at both clamp locations. Do not remove steering shaft at this time, once the body is lifted the shaft is easily removed for modification.
10. Remove body mount bolts at the following locations as indicated – Fig 4: FRONT MOUNT, P1, P2, P3, P4, P5, P6, and D6.

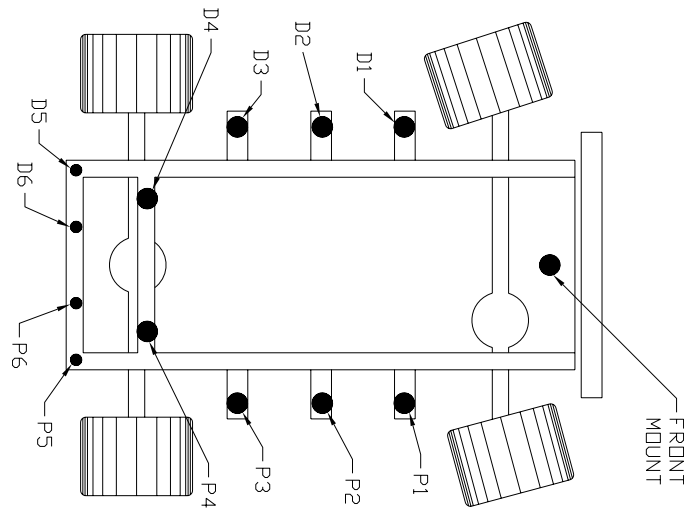

Figure 4

11. LOOSEN the remaining body mount bolts located at the following points: D1, D2, D3, D4, and D5. Do not remove at this time.
12. Carefully raise the passenger's side of the vehicle 1-2" and check cables/hoses/wires for proper clearances.
13. Raise passenger's side of vehicle until blocks can be placed above bushing and below body. Large diameter blocks are placed at P1, P2, P3, and P4. A small diameter block goes in position P5. Position P6 and D6 can be placed once all other blocks have been placed.
14. Apply Loctite to threads and install 3/8" x 4-1/2" bolts and washers at P1, P2, P3, and P4, 7/16" x 4-1/2" bolts with new washers at P5, do not tighten at this time.
15. Repeat above procedure for driver's side, do NOT install block and bolt at location D1. This position requires the clutch bracket and the lift block that is 3/16" smaller than the rest.
16. Install small diameter blocks along rear bumper (D6, P6) with 7/16" x 4-1/2" bolts.
17. Install large diameter block at front mount with 7/16" x 4-1/2" bolt and new 7/16" USS washer.
18. With the body lifted remove steering shaft.
19. Clamp shaft in vice and carefully drill out locking points, do not use drill bit larger than 5/32", just drill through outer shaft casing – Fig 5.

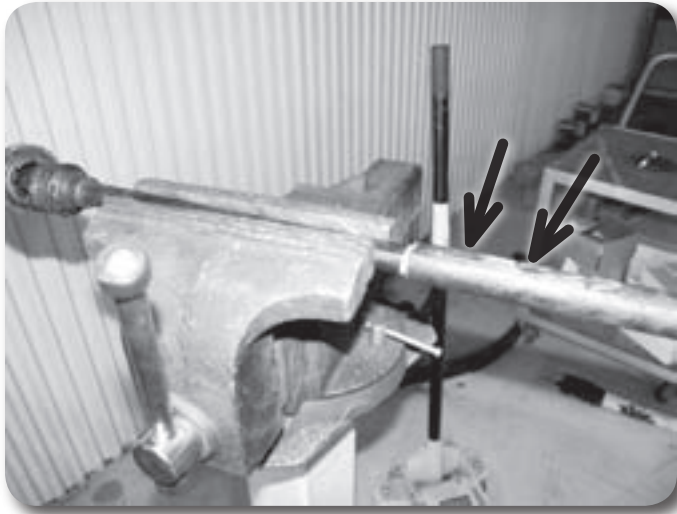

Figure 5

20. Disassemble shaft, clean, apply anti-seize to allow shaft to slide easily, and reassemble.
21. Reinstall steering shaft into vehicle by aligning marks previously made.
22. Torque steering hardware 3/8" (lower clamp) to 30 ft-lbs and 7/16" hardware (upper clamp) to 50 ft-lbs.
23. Drill 1/8" hole at OE hole locations through entire steering shaft.
24. Install 1/8" rolled pin through holes just drilled – Fig 6.

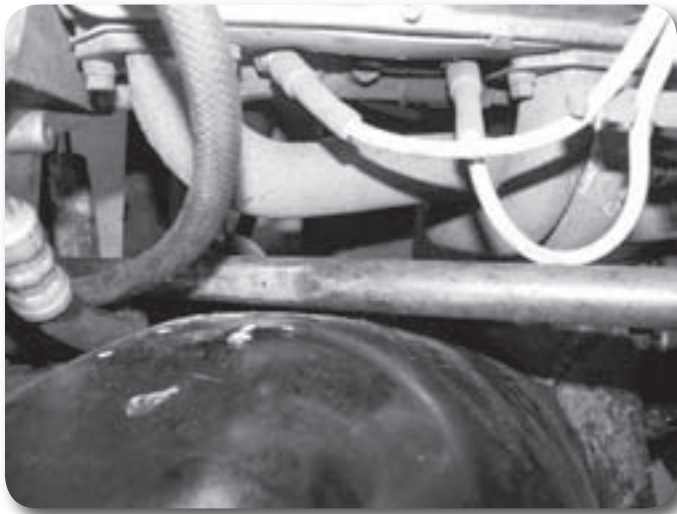

Figure 6

25. Measure overall length of clutch linkage and record.
26. Measure 2-1/2" up from lower mount on clutch linkage and mark. Also make an alignment mark down the length of the linkage, perpendicular to the cut line. This line will aid in aligning the two pieces correctly after they are cut. Cut the linkage in half at the cut line. – Fig 7.

**Important—measure  
clutch linkage!**

---

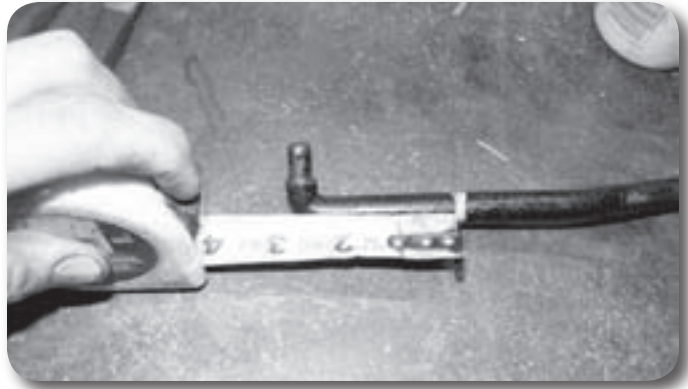

Figure 7

27. Remove paint from linkage up to 1" away from cut.
28. Mark ½" away from cut on both ends of linkage.
29. Install sleeve onto linkage aligning marks – Fig 8.

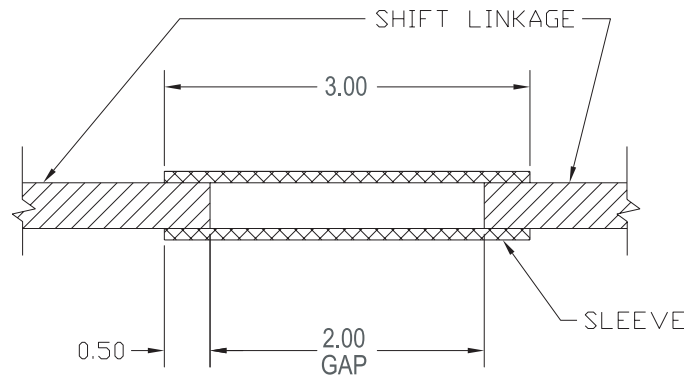

Figure 8

30. Double check overall length, length should be 2" longer than stock (Reference step 24). IMPORTANT: ensure that ends are facing opposite directions and alignment marks are in line..
31. Weld along both ends of sleeve. Certified welder recommended.
32. Cut or remove lower clutch bracket mounting stud – Fig 9.

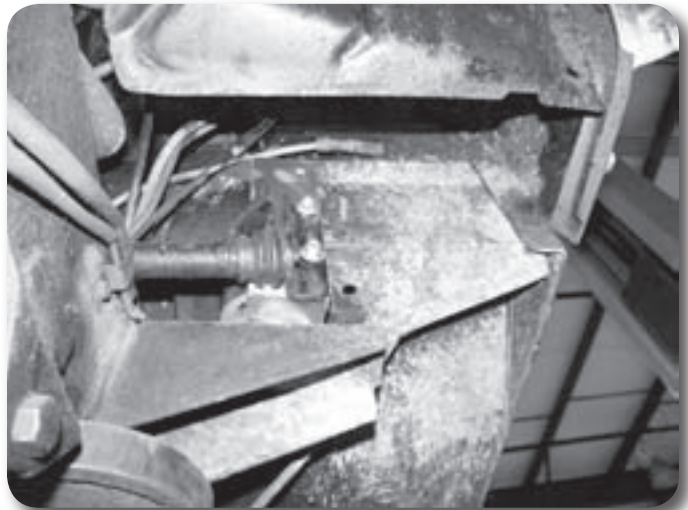

Figure 9

33. Install bracket as shown with factory nut at top mounting point – Fig 10.

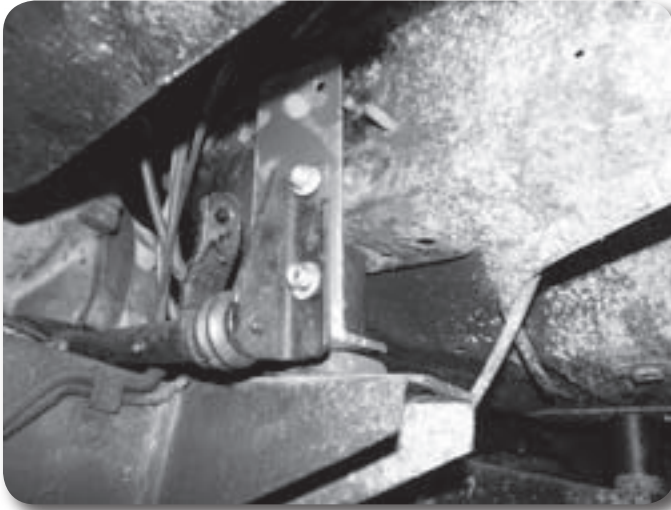

Figure 10

34. Place the short lift block on top of bracket and above the rubber bushing then install 3/8" x 4-1/2" bolt.
35. Reinstall clutch linkage bracket with 5/16" hardware from hardware park #428.
36. Reinstall clutch linkage. Use new 1/16" x 1" cotter pins provided for reinstallation.
37. Torque all body mounts as follows: 3/8" – 30 ft-lbs, 7/16" – 50 ft-lbs.
38. Check shift lever movement, minor trimming of floor pan around shift boot required – Fig 11.

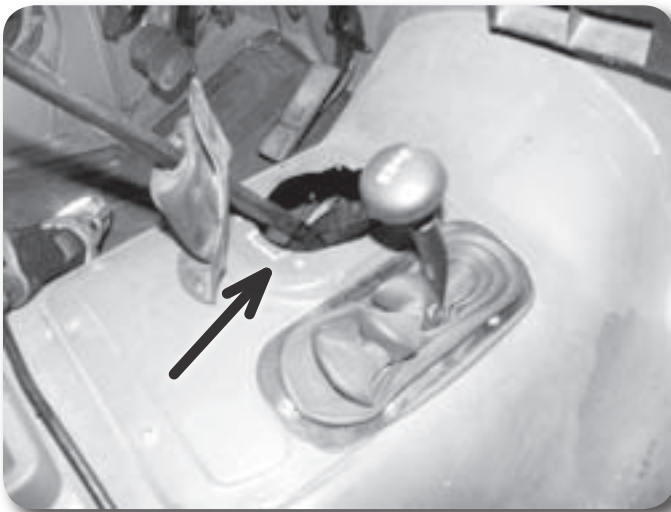

Figure 11

39. Repeat above step for transfer case shift lever.
40. Double check all wires/cables/hoses after lift to ensure that none are over-extended and no interference occurs.
41. Check all fasteners after driving 500 miles and at regularly scheduled maintenance intervals.

## Post-Installation Warnings

1. Check all fasteners for proper torque. Check to ensure for adequate clearance between all rotating, mobile, fixed, and heated members. Verify clearance between exhaust and brake lines, fuel lines, fuel tank, floor boards and wiring harness. Check steering gear for clearance. Test and inspect brake system.
2. Perform steering sweep to ensure front brake hoses have adequate slack and do not contact any rotating, mobile or heated members. Inspect rear brake hoses at full extension for adequate slack. Failure to perform hose check/replacement may result in component failure. Longer replacement hoses, if needed can be purchased from a local parts supplier.
3. Perform head light check and adjustment.
4. Re-torque all fasteners after 100 miles. Always inspect fasteners and components during routine servicing.