



3651 N Highway 89 • Chino Valley, AZ 86323
(928) 636-7080 • www.p-a-g.net

TOYOTA TUNDRA 3" BODY LIFT INSTALLATION INSTRUCTIONS 2014 KIT# 5643

⚠ WARNING

Installation of a Performance Automotive Group body lift kit will change the vehicle's center of gravity and handling characteristics both on- and off-road. You must drive the vehicle safely! Extreme care must be taken to prevent vehicle rollover or loss of control, which could result in serious injury or death. Avoid sudden sharp turns or abrupt maneuvers and always make sure all vehicle occupants have their seat belts fastened.

⚠ WARNING

Before you install this kit, read and understand all instructions, warnings, cautions, and notes in this instruction sheet and in the vehicle owner's manual.

⚠ CAUTION

Proper installation of this kit requires knowledge of the factory recommended procedures for removal and installation of original equipment components. We recommend that the factory shop manual and any special tools needed to service your vehicle be on hand during the installation. Installation of this kit without proper knowledge of the factory recommended procedures may affect the performance of these components and the safety of the vehicle. We strongly recommend that a certified mechanic familiar with the installation of similar components install this kit.

⚠ WARNING

DO NOT combine suspension, body, or other lift devices. Use of vehicle with combined lifts may result in unsafe and/or unexpected handling characteristics.

⚠ WARNING

This kit should only be installed on a vehicle that is in good working condition. Before you install the kit, thoroughly inspect the vehicle for corrosion or deformation of the sheet metal around the factory body mounts. If the vehicle is suspected to have been in a collision or misused, do not install this kit. Off-road use of your vehicle with this kit installed may increase the stress applied to the factory body mounts. We do not recommend that any vehicle with a body lift kit installed be involved in any extreme off-road maneuvers such as jumping. Failure to observe this warning may result in serious personal injury and/or severe damage to your vehicle.

⚠ WARNING

Many states and municipalities have laws restricting bumper heights and vehicle lifts. Consult state and local laws to determine if the changes you intend to make to the vehicle comply with the law.

⚠ WARNING

The installation of larger tires may reduce the effectiveness of the braking system.

⚠ WARNING

Always wear eye protection when operating power tools.

⚠ WARNING

Before you install this kit, block the vehicle tires to prevent the vehicle from rolling.

⚠ WARNING

Accidental deployment of the air bag can result in serious personal injury or death. To avoid accidental deployment during installation of the kit, the Supplemental Restraint System (SRS, or airbag) must remain deactivated. Do not allow anyone near the airbag during installation. Refer to the factory service manual or owner's manual for the recommended procedure to disable the SRS. After you install the kit, reactivate the SRS before driving the vehicle.

NOTE

Performance Automotive Group recommends using the Loctite® supplied in the kit on the threads of all kit nuts and bolts unless specified otherwise in these instructions.

Before Starting Installation

NOTE
Kit parts are prefaced by the word *kit* and appear in **bold** print.

1. Carefully read all warnings and instructions completely before beginning.
2. Verify all parts have been received in this kit by checking the parts list at the end of this document.

NOTE
If parts are missing from kit, please be prepared to provide the following information:
1. **Name** of purchase location
2. **Bar Code** on side of box
3. **Date** above bar code
4. **Date** inside box cover
5. **Inspector #** from inside box cover

3. **Only install this kit on the vehicle for which it is specified.** If anytime during the installation you encounter something different from what is outlined in the instructions, call technical support at (928) 636-7080.
4. Special tools needed:
 - a. 1/4" drill bit and drill (Rear Bumper).
 - b. Die grinder or similar tool capable of cutting metal (Rear Bumper & Fuel Filler).
5. Park vehicle on a clean, dry, flat, level surface and block tires so vehicle cannot roll in either direction.

Engine Compartment

1. Disconnect both battery cables. Disconnect negative cable first, then positive cable.

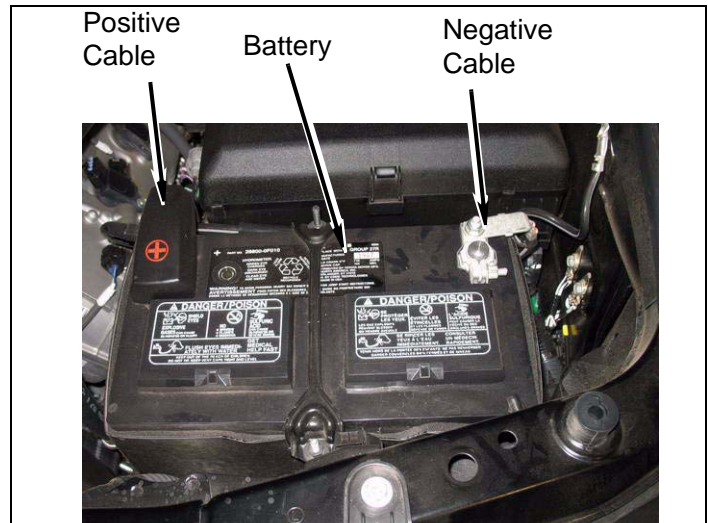

2. Airbag Fuse

NOTE
The location of the airbag fuse may vary; check the owner's manual.

- a. Remove fuse cover.
- b. Remove airbag fuse.

Prepare to Install Kit

Measurements

1. Measure and record distance between front bumper and fenders.
Driver Side _____ Passenger Side _____
2. Measure and record distance between rear bumper and bed
Driver Side _____ Passenger Side _____
3. Measure and record distance between cab and bed.
Driver Side _____ Passenger Side _____

Engine Compartment

1. Engine Cover

- a. Remove engine cover from vehicle by pulling up from two retaining posts.

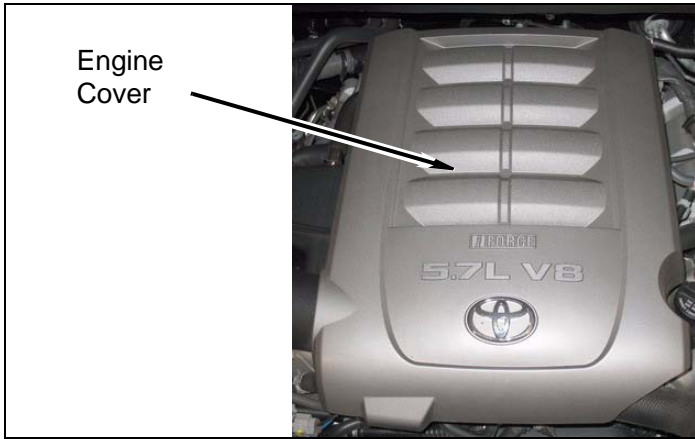

2. Airbox

- a. Remove wire harness connector and wire harness clip.
- b. Unclip four airbox clips, loosen hose clamp and remove airbox cover.

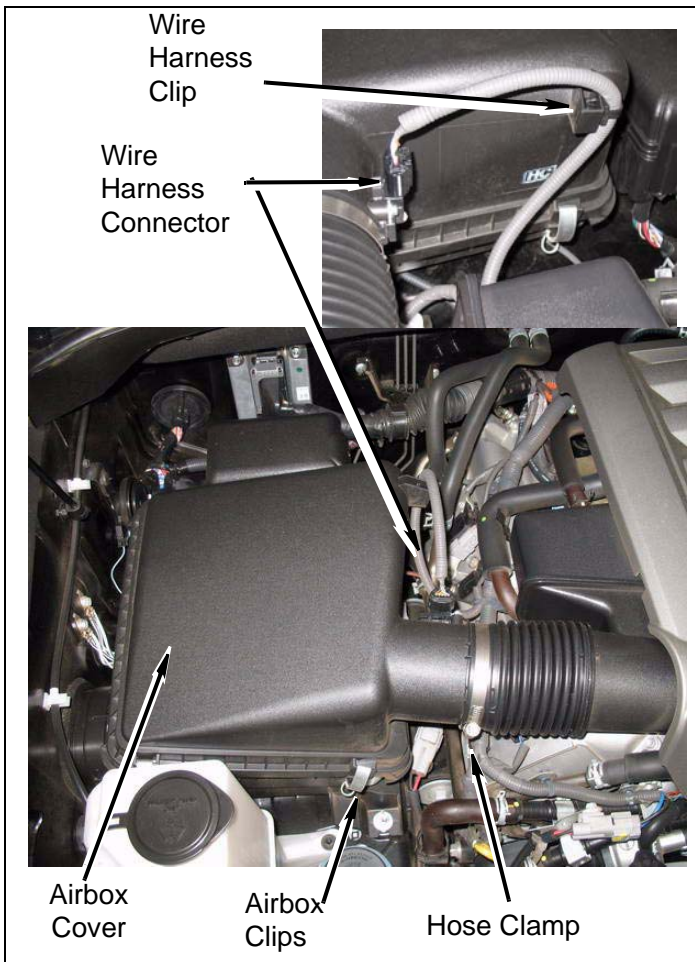

- c. Loosen hose clamp and remove inlet hose from intake manifold.

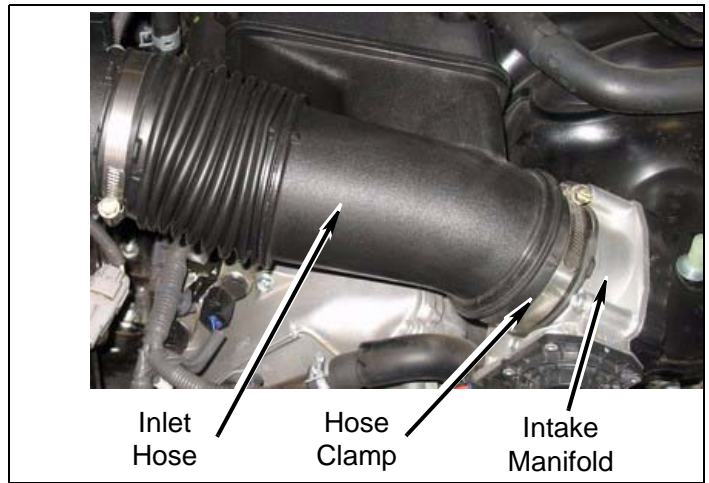

- d. Remove two bolts from base of airbox at fender. Remove airbox from vehicle..

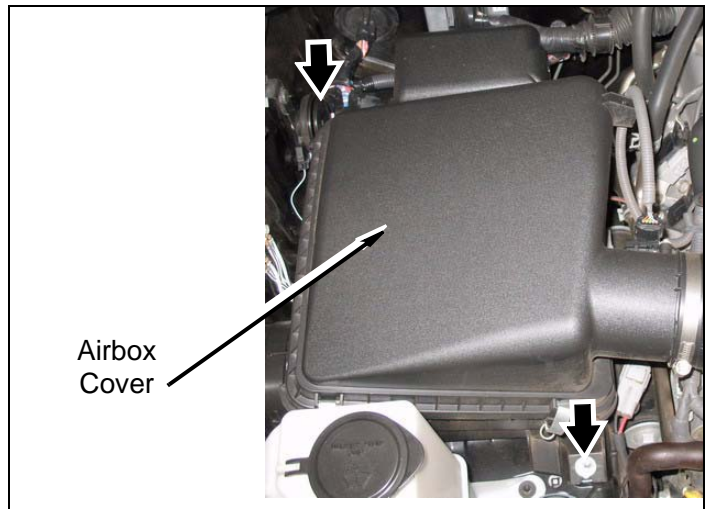

- e. Remove air inlet from side of airbox.

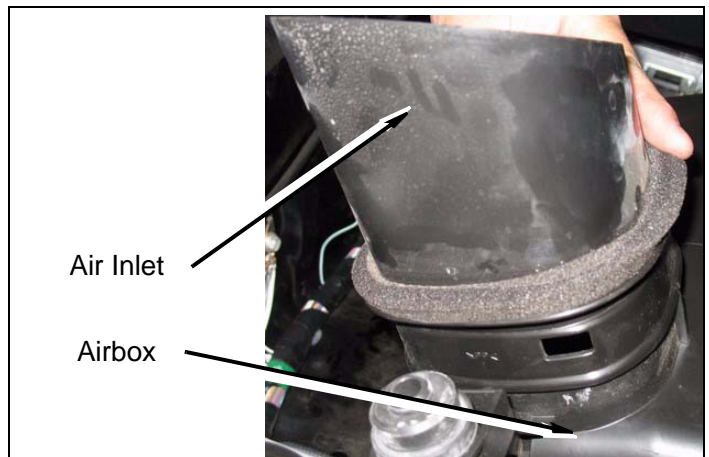

NOTE

The air inlet will not be reinstalled on the airbox after lift.

3. Power Steering

a. Drain fluid from power steering reservoir.

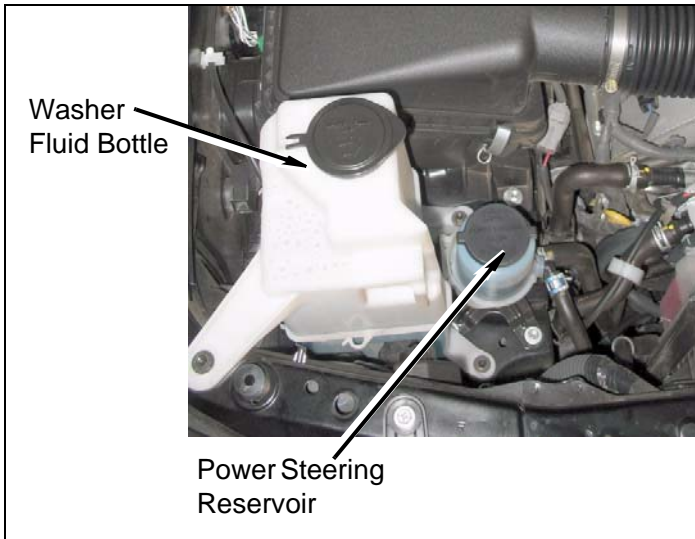

b. Mark and cut both power steering hoses as shown.

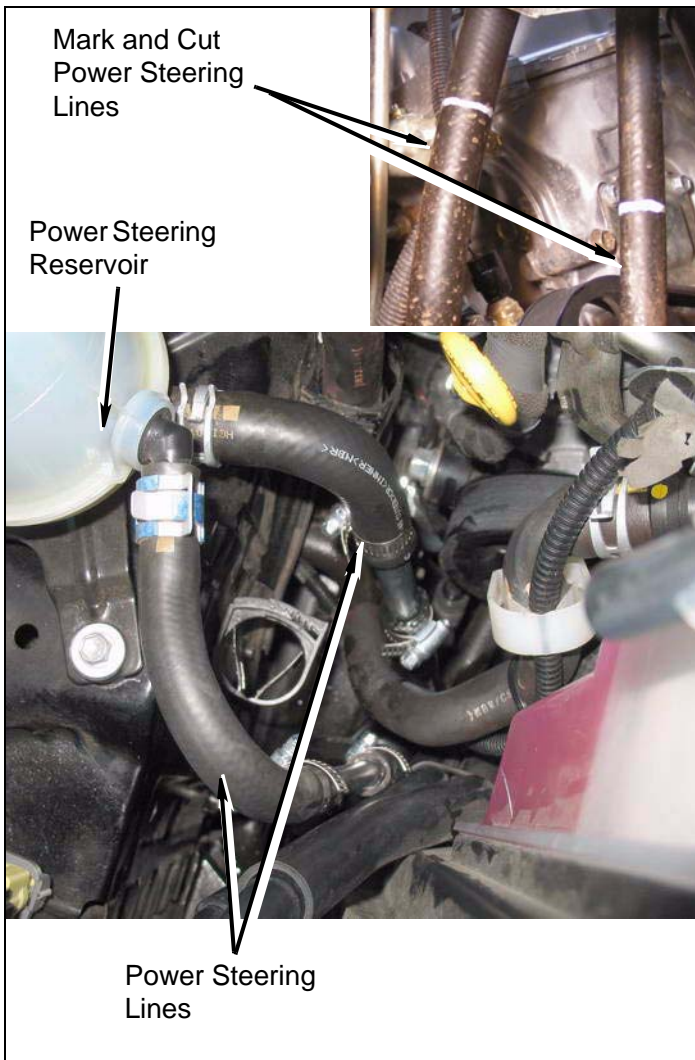

c. Install **kit extensions** (3/8") and two **kit clamps** (hose # 10) as shown. Install **kit extensions** (7/16") and two **kit clamps** (hose # 6) as shown. Tighten **kit hose clamps**.

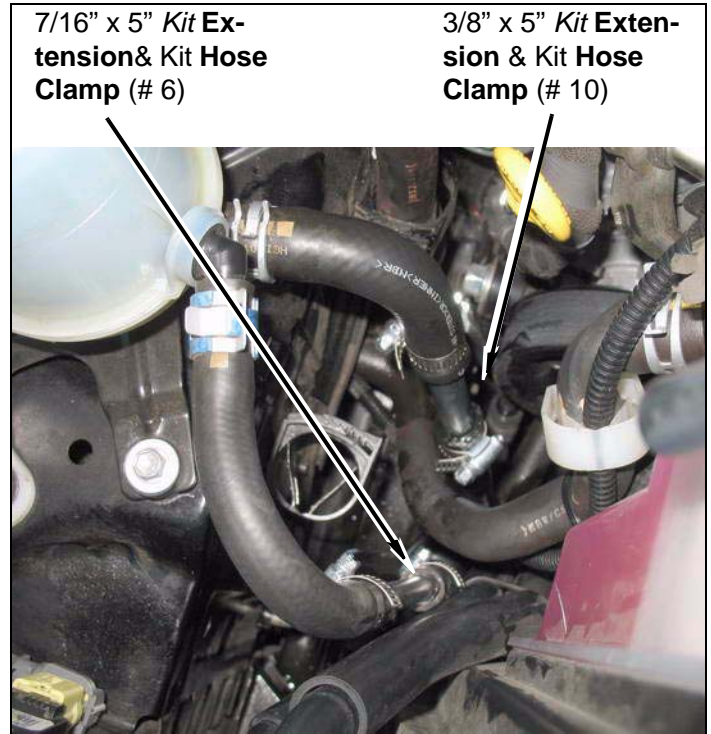

d. Refill steering reservoir with approved power steering fluid as specified in owners manual.

4. Battery Cable and Harnesses

a. Remove positive battery cable from two retaining clamps.

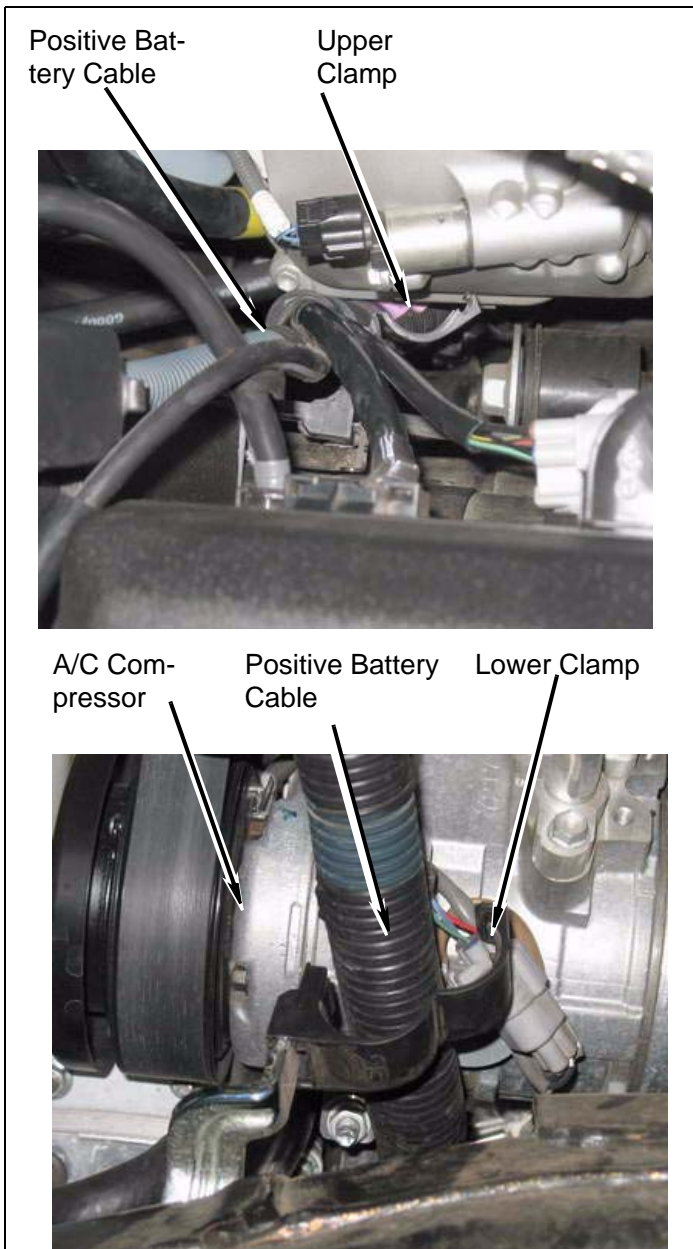

b. Remove five bolts and front engine splash shield from vehicle.

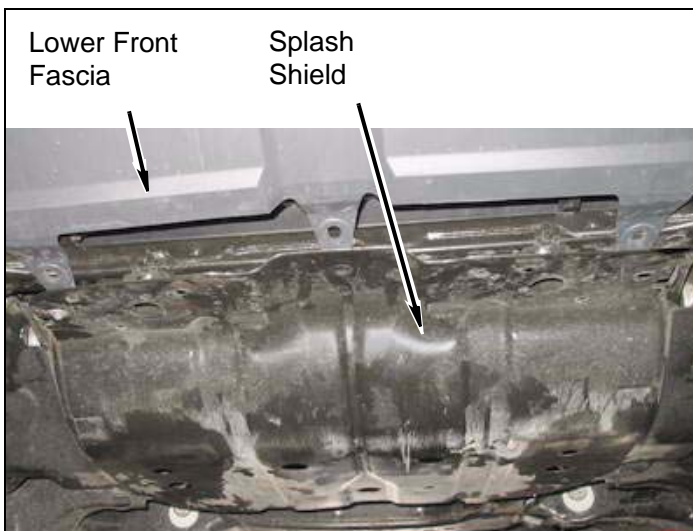

c. Remove positive battery cable from two clips along bottom front of engine.

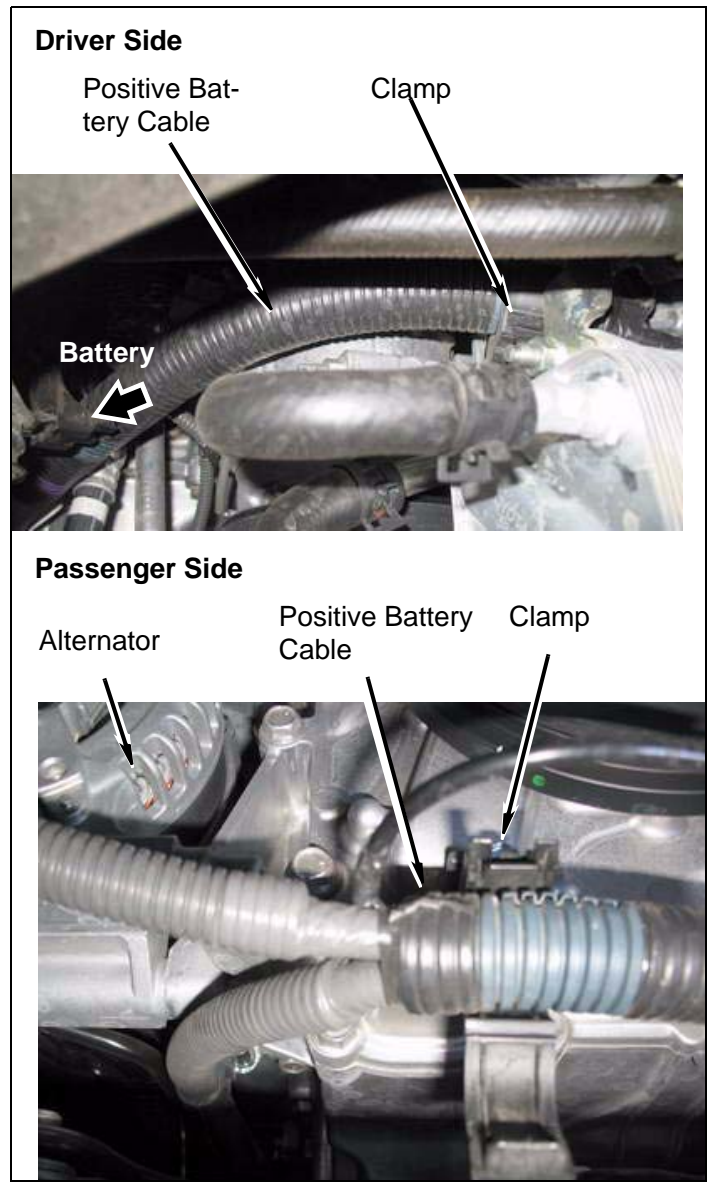

d. Remove ABS wire harness from bracket.

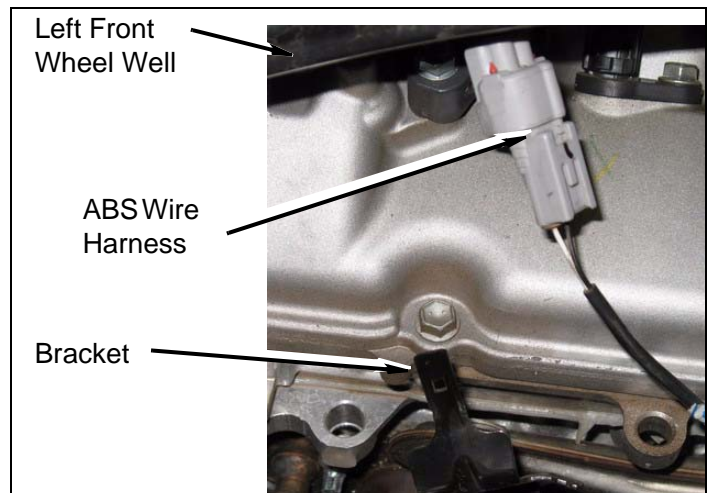

5. Steering Shaft

⚠ WARNING

Accidental deployment of the air bag can result in serious personal injury or death. To avoid accidental deployment during installation of the lift kit, the Supplemental Restraint System (SRS, or airbag) must remain deactivated. Do not allow anyone near the airbag during installation. Refer to the factory service manual or owner's manual for the recommended procedure to disable the SRS. After kit installation, the SRS must be reactivated before driving the vehicle.

⚠ CAUTION

If the following step is not performed, the airbag clock-spring could be damaged. Do not turn the steering wheel while the steering shaft is disconnected.

- a. Strap steering wheel to prevent accidental movement.
- b. Mark upper steering shaft in relation to lower steering shaft as shown.

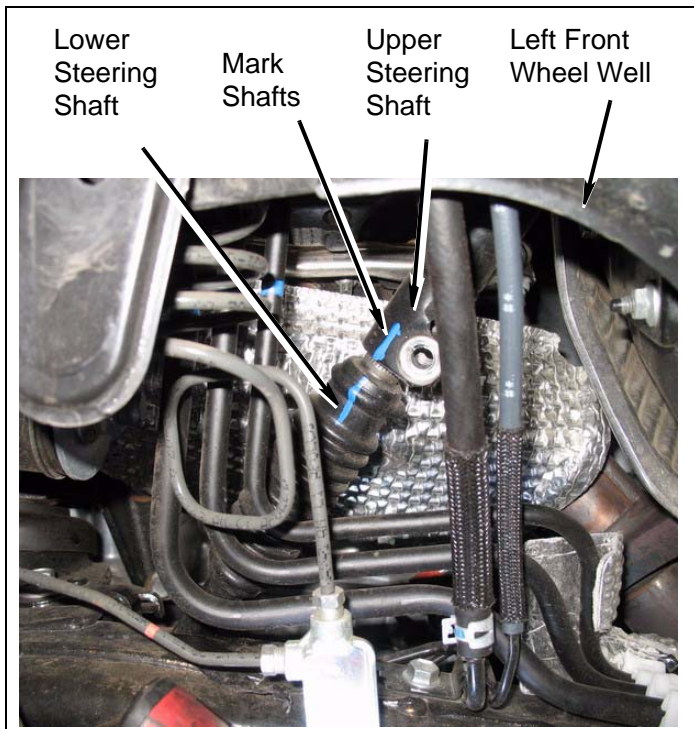

- c. Remove bolt from steering shaft.

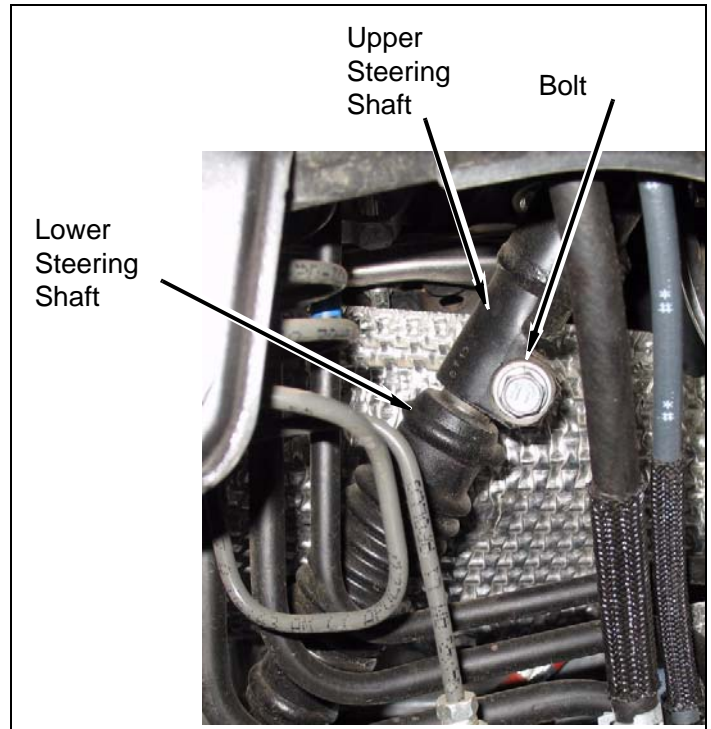

6. Hoses and Harnesses

- a. Un-clip two wire harnesses near air box.

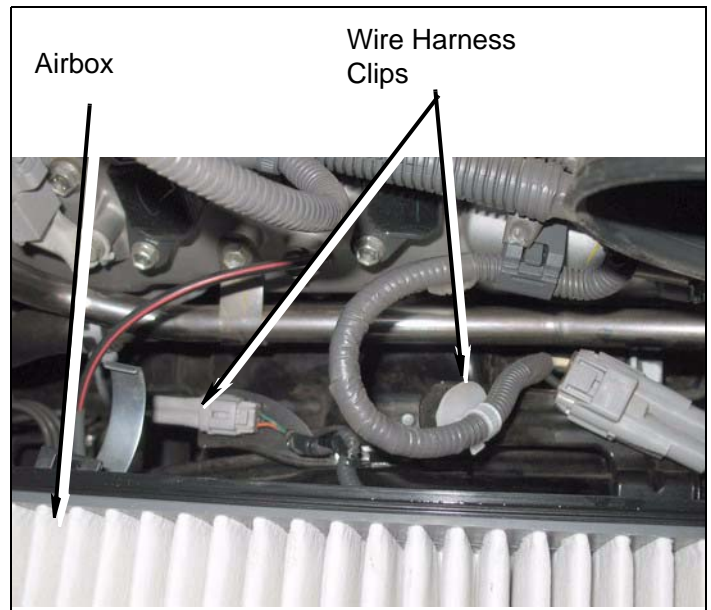

b. Remove two clips from harness at back of air box.

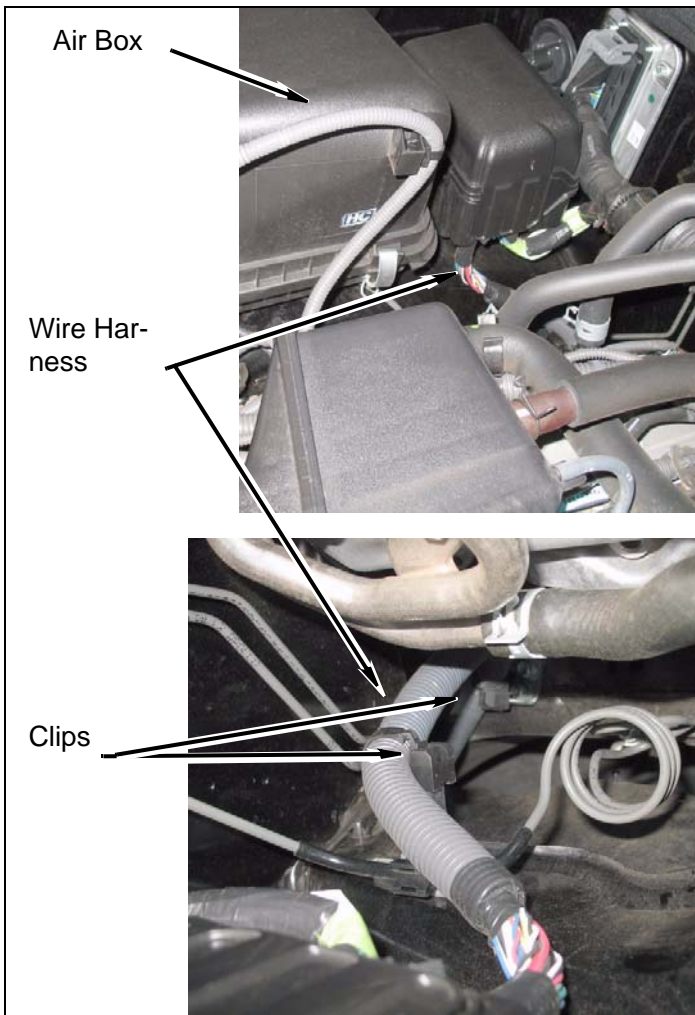

b. Remove two clips in both front wheel wells.

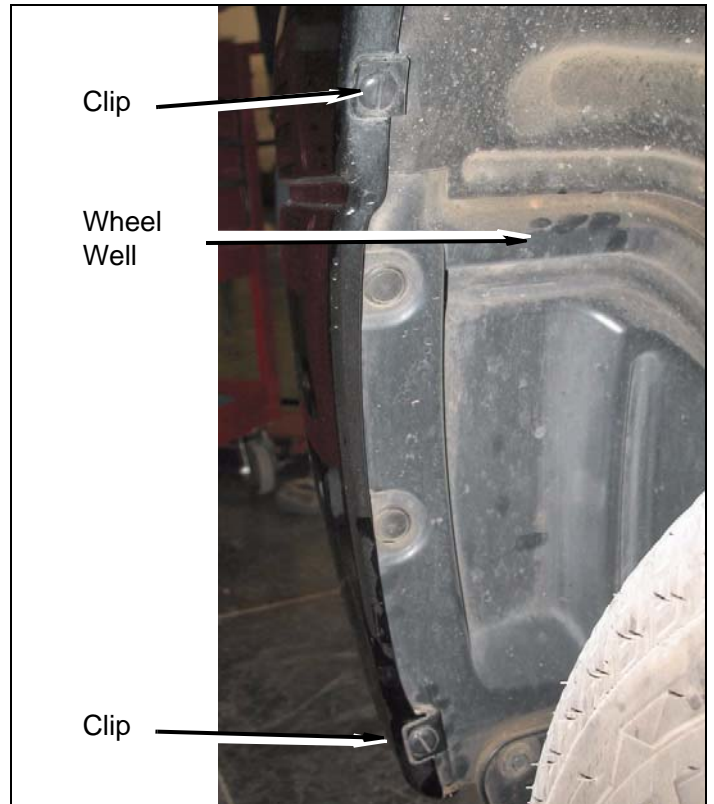

c. Remove two bolts in wheel wells.

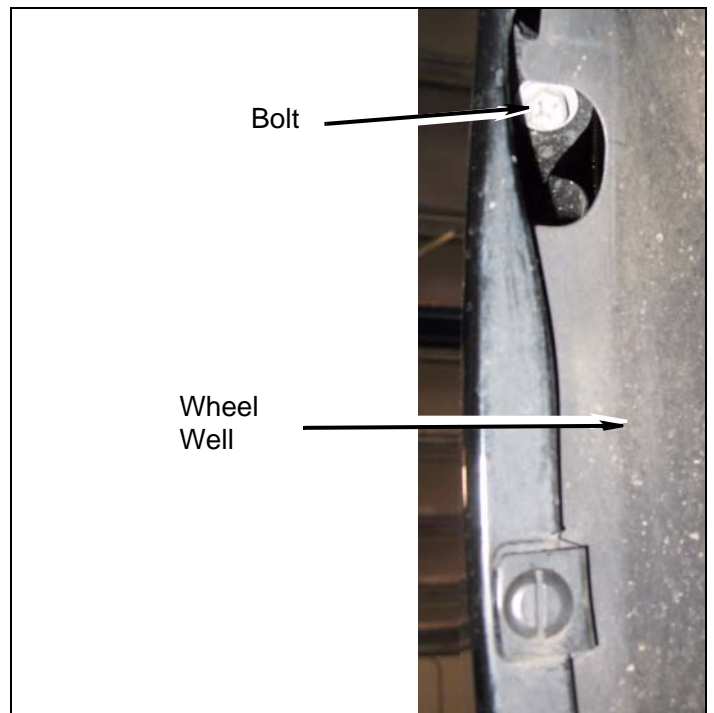

Front of Vehicle

1. Front Bumper

a. Remove four bolts and two clips, followed by the grille assembly.

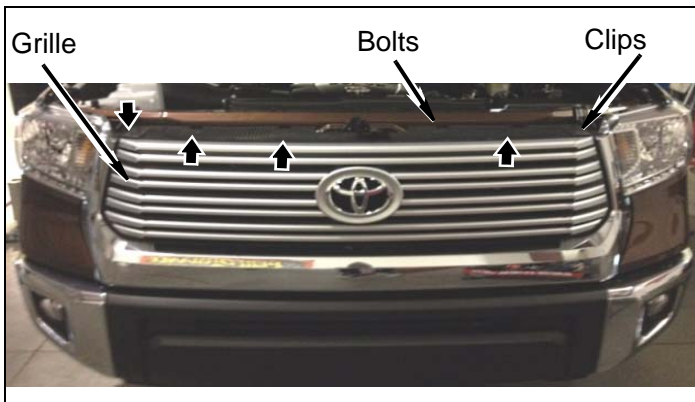

d. Remove four push clips from front fascia.

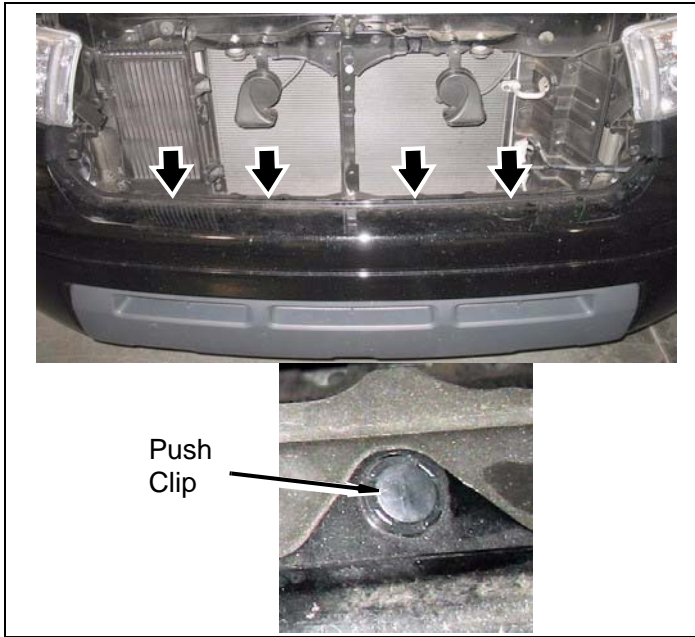

f. Remove four bolts on each corner under fascia.

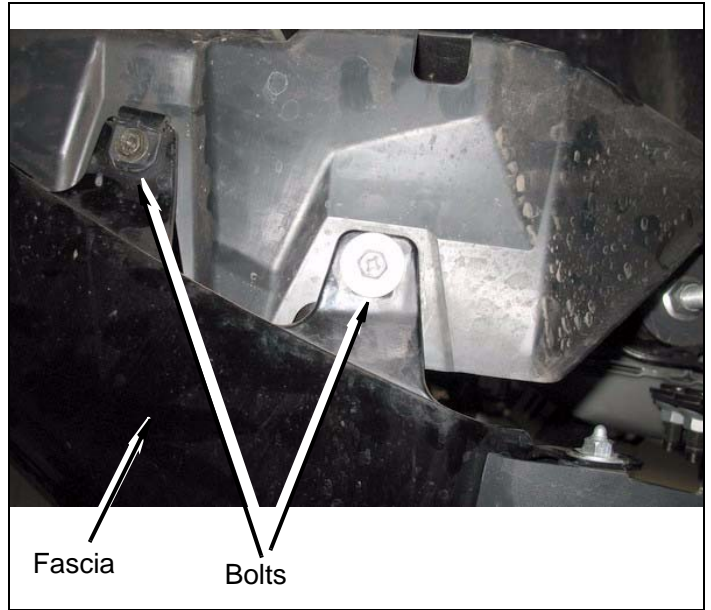

e. Remove three push clips from bottom of fascia.

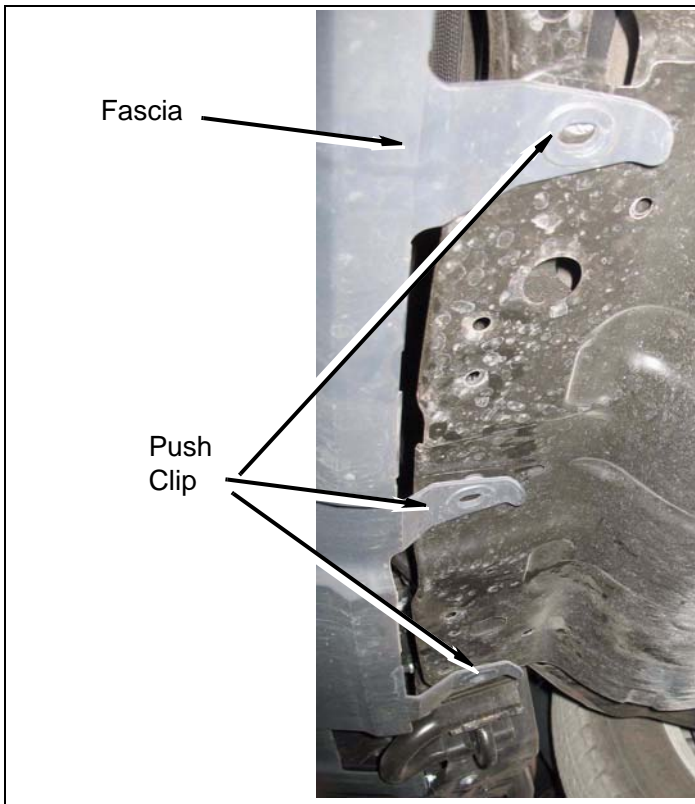

g. Remove four push clips from panel.

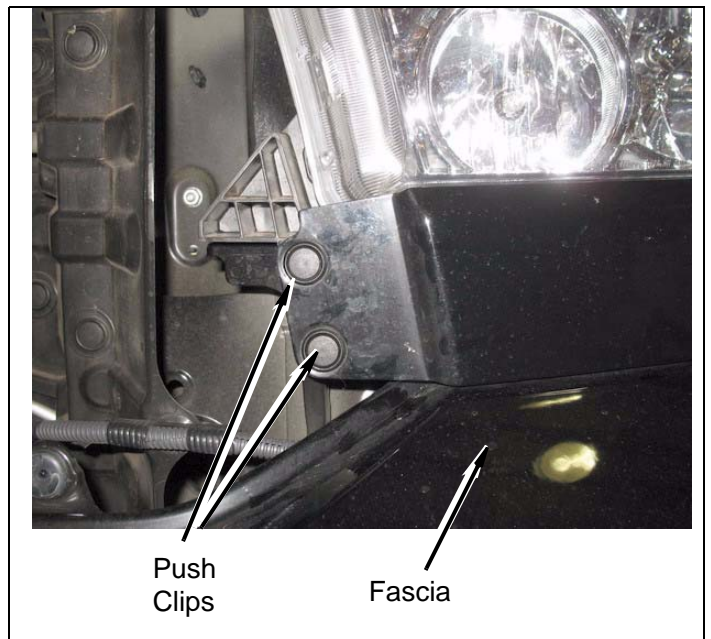

h. Pull back panel from under head lamp and remove two bolts from each corner of bumper.

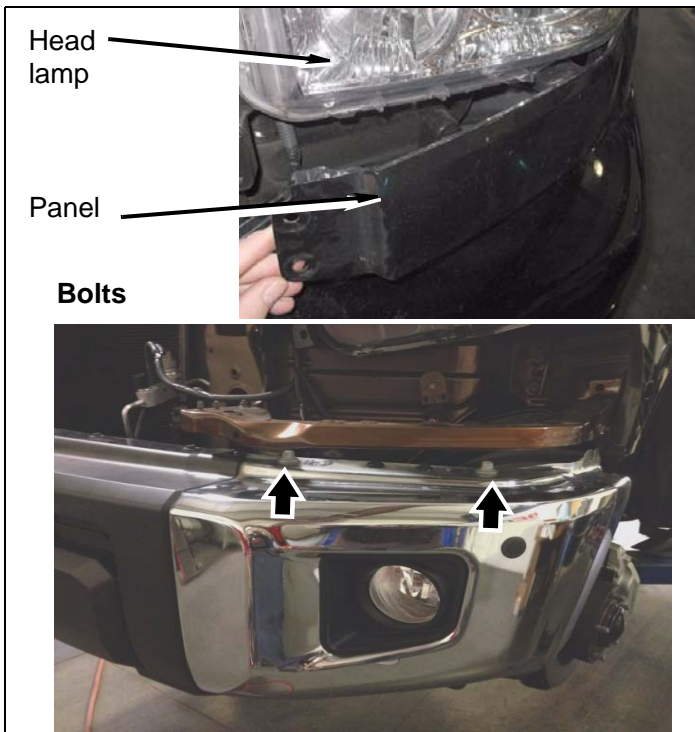

i. Remove wire harness from two fog lamps.

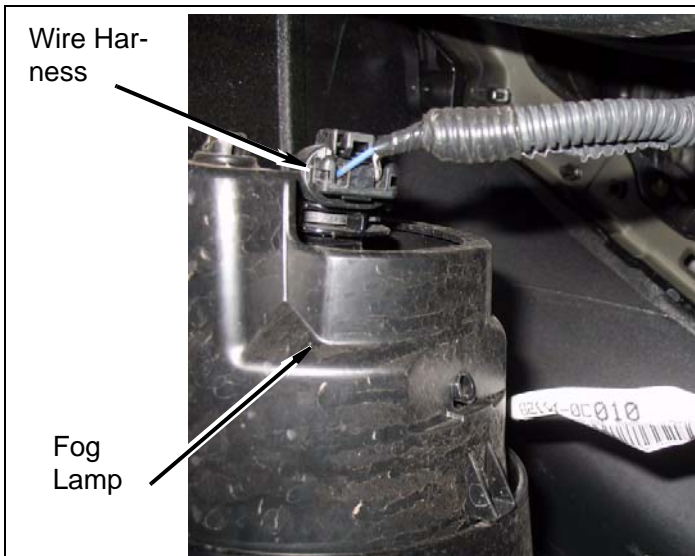

j. Disconnect two park assist wire harnesses from each corner of front fascia.

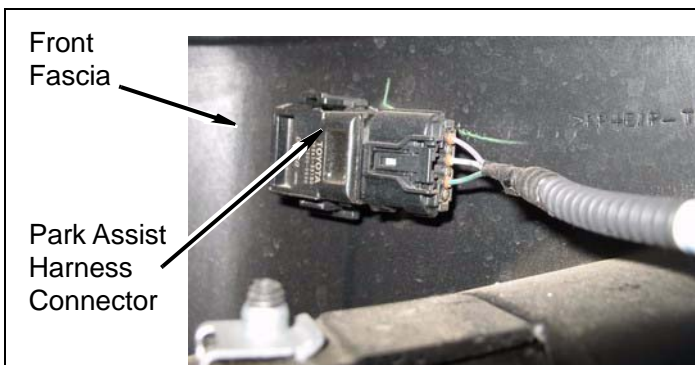

k. Remove front fascia from vehicle.

l. Remove six nuts and bumper from vehicle.

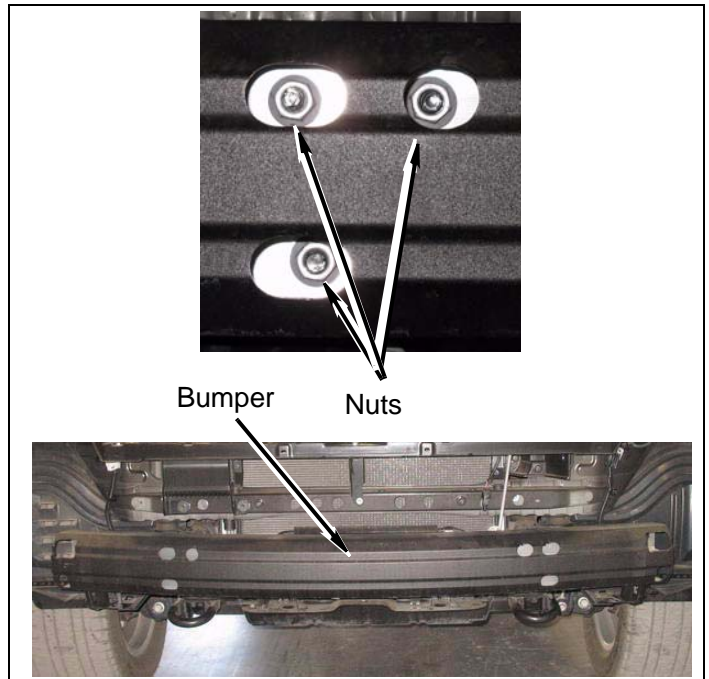

m. Remove eight nuts and OEM bumper brackets from vehicle.

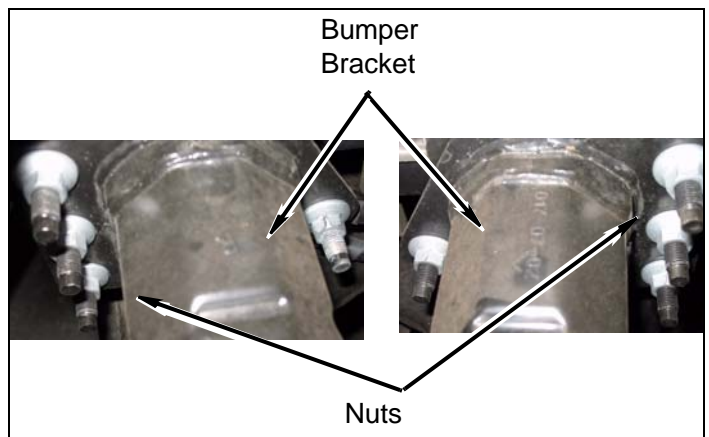

2. Fan Shroud and Radiator

a. Remove four radiator mounting bolts from front of vehicle.

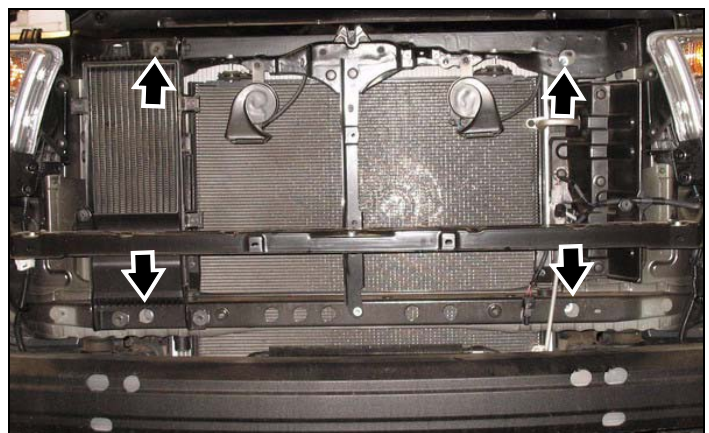

Inside of Vehicle

1. Trim

- a. Remove kick panel from both passenger and driver side.

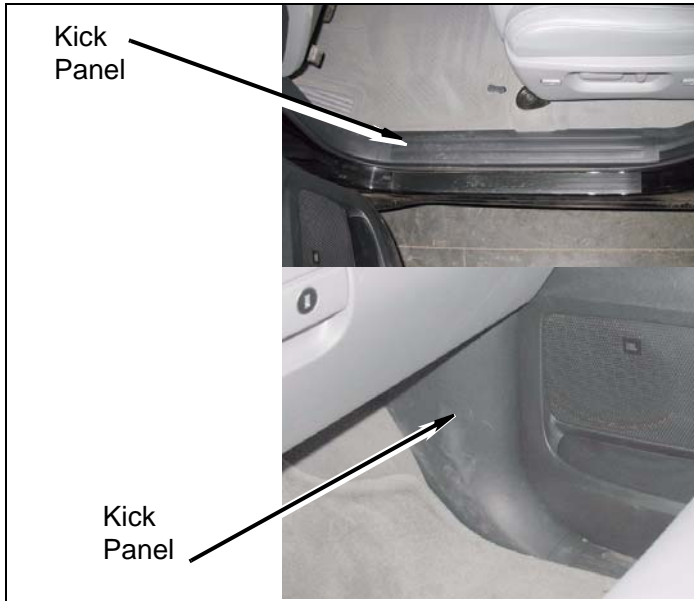

- b. Remove two plastic nuts from kick panel under dash.

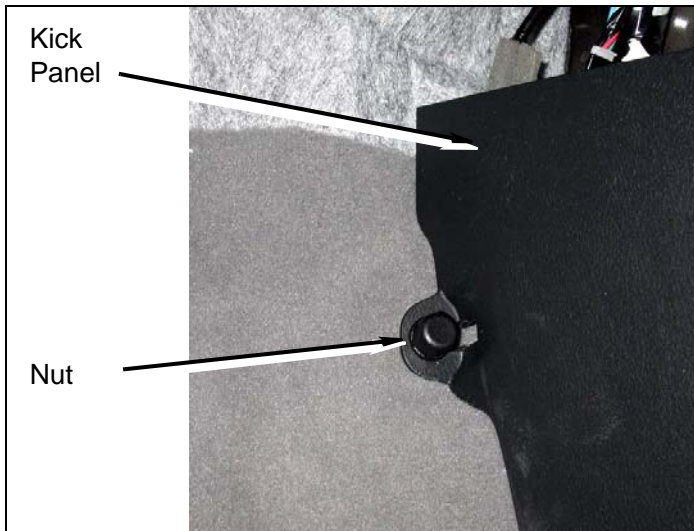

- c. Pull back carpet in corner to allow access to the body mount bolts located under black floor plug. NOTE: Rear seats and plastic side panels may need to be removed to access carpet and plug,

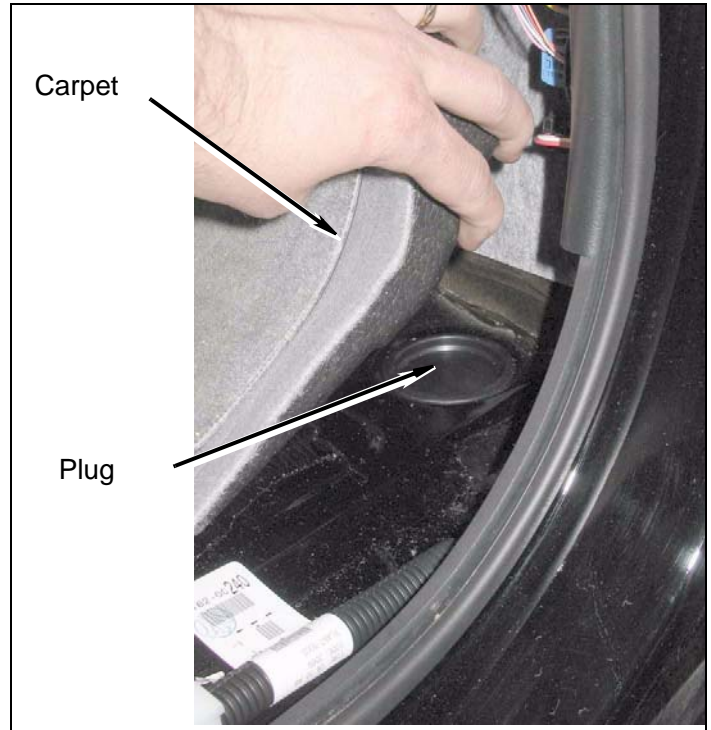

- d. Pull back carpet to allow access to rear body mount bolts under plastic plugs.

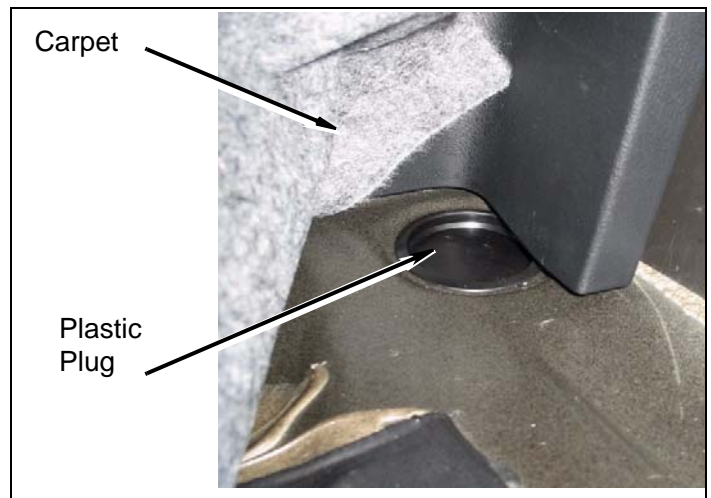

Underside of Vehicle

1. Remove push clips and four splash guards in both front wheel wells.

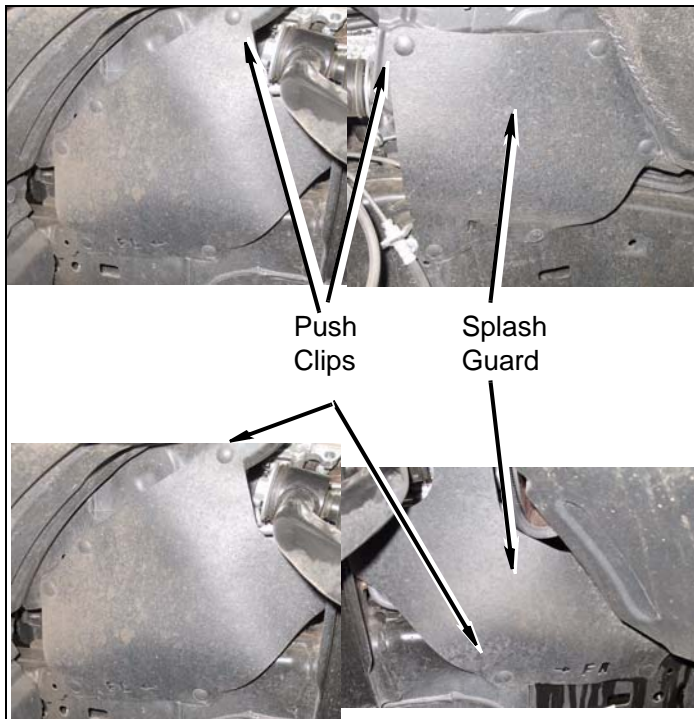

2. Vent Hose

- a. Remove vent hose clip from driver side wheel well lip.

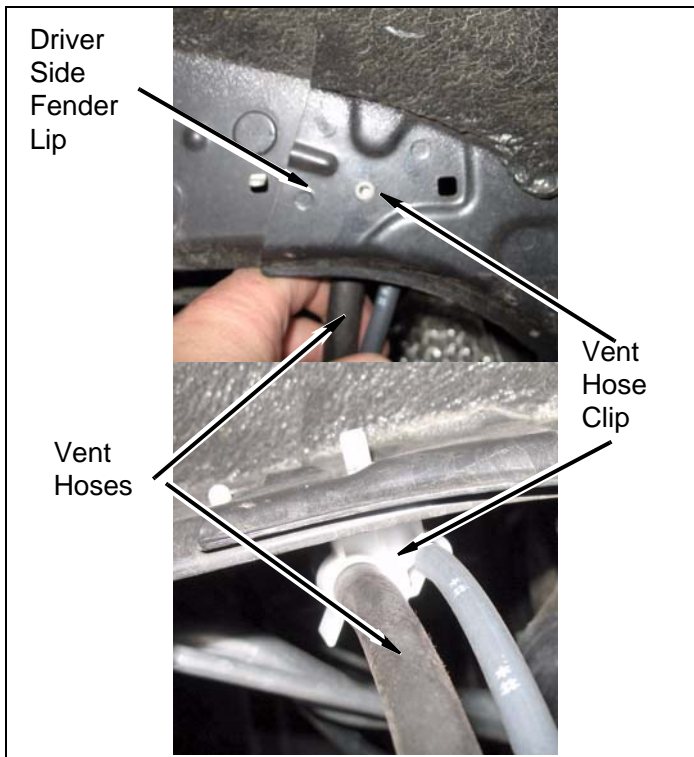

3. Park Brake Cable

- a. Remove nut and park brake cable bracket from body under driver door.

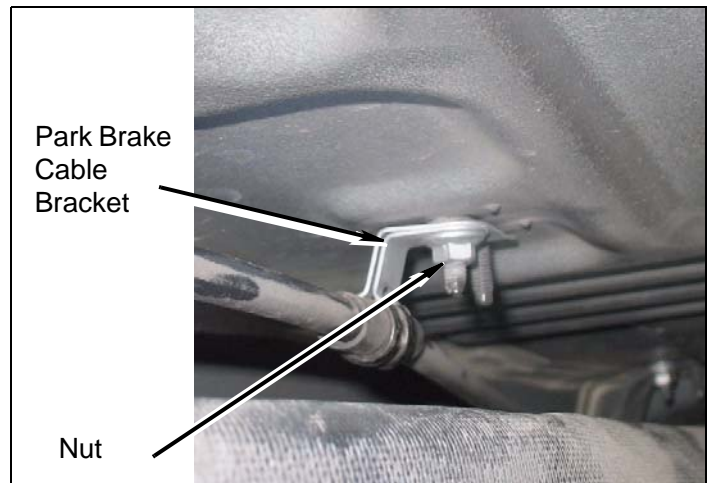

Miscellaneous Rear of Vehicle

Rear of Vehicle

1. Fuel filler

⚠ WARNING

Use extreme caution when working near the fuel lines and the fuel tank. Clean up spilled fuel immediately. A spark could cause an explosion or fire resulting in serious personal injury and property damage.

- a. Disconnect plastic and rubber hoses from metal fuel filler lines.
- b. Remove two nuts, bracket and fuel filler from vehicle.

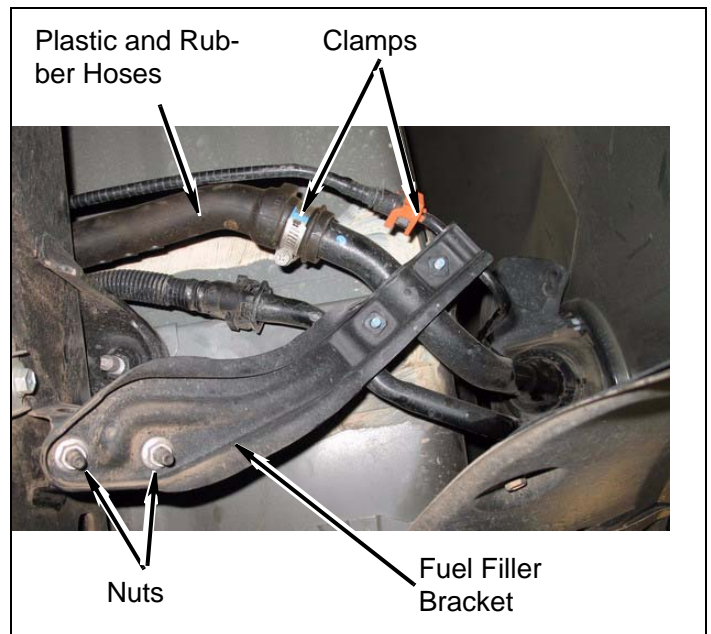

- c. Mark fuel filler metal lines as shown. Cut fuel filler at each line. NOTE: Some models may have small shield attached, cut and remove shield carefully before cutting fuel filler as shown below:

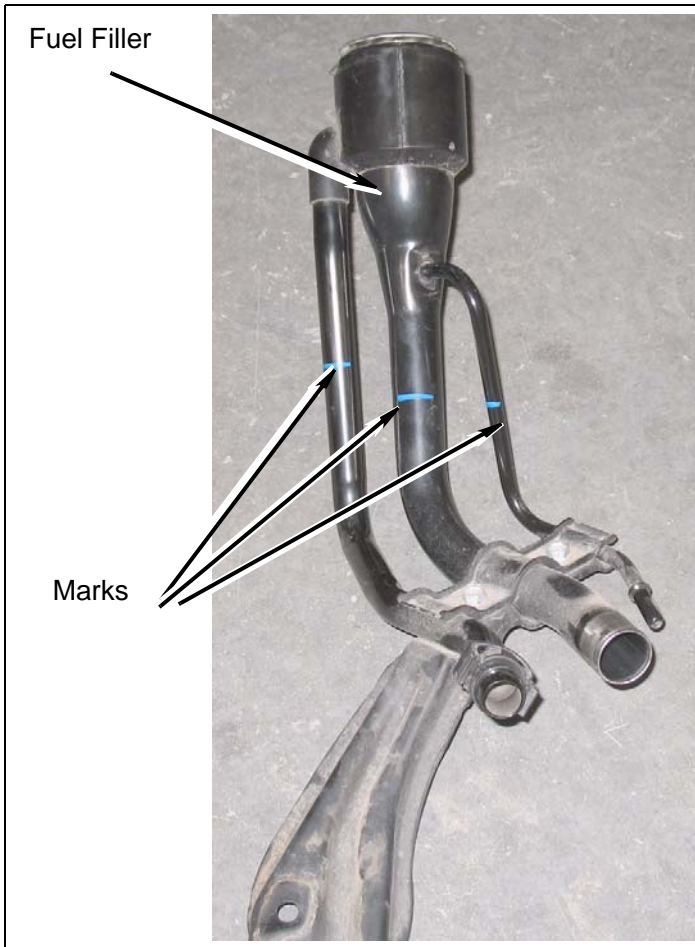

- d. Install kit hoses and hose clamps as shown.

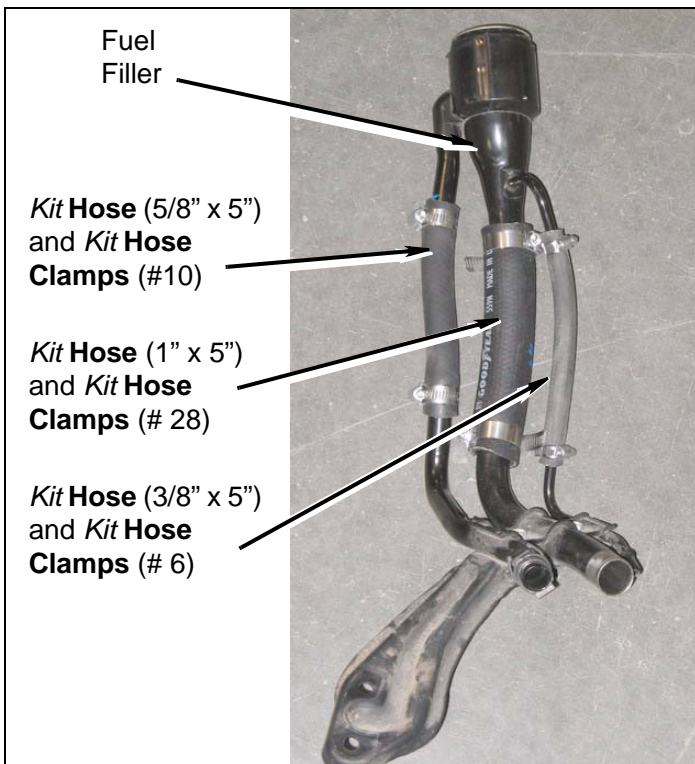

2. Rear bumper

- a. Remove two back up sensor wire harnesses at each end of rear bumper

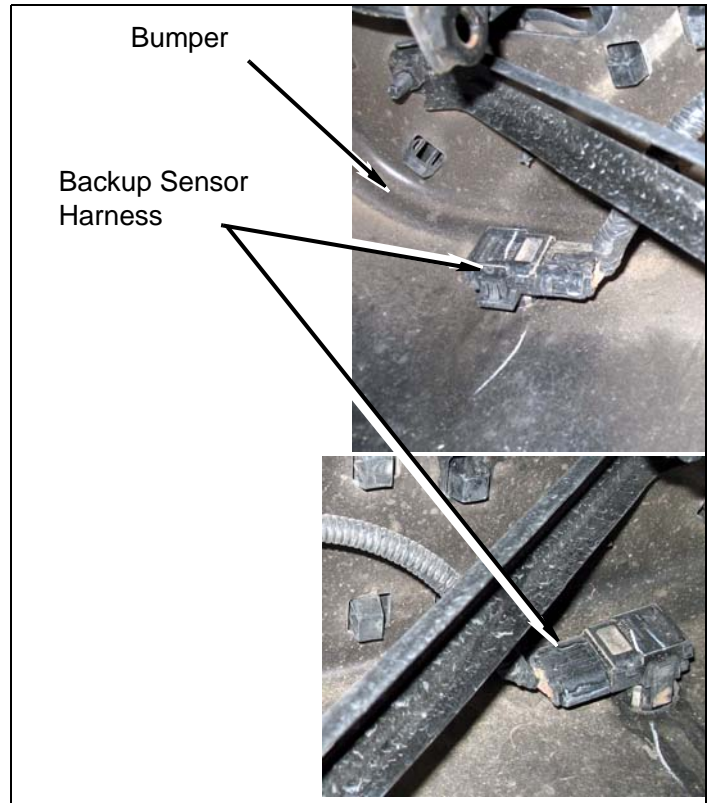

- b. Remove two backup sensor wire harness clips from under bumper

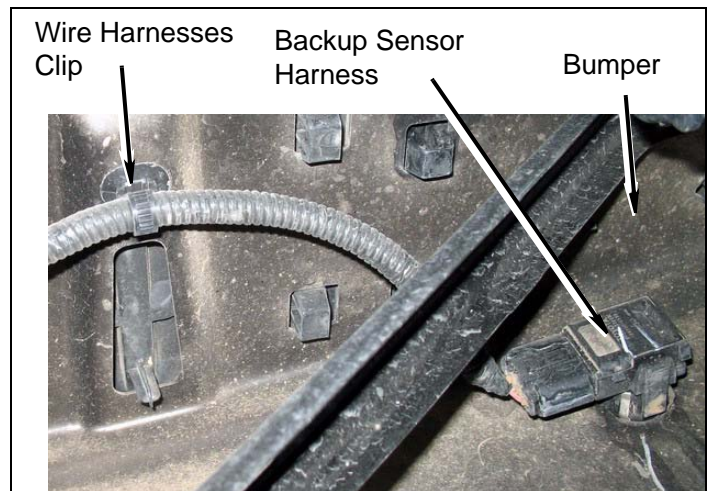

c. Remove clip and wire harnesses from bed of truck on driver side rear.

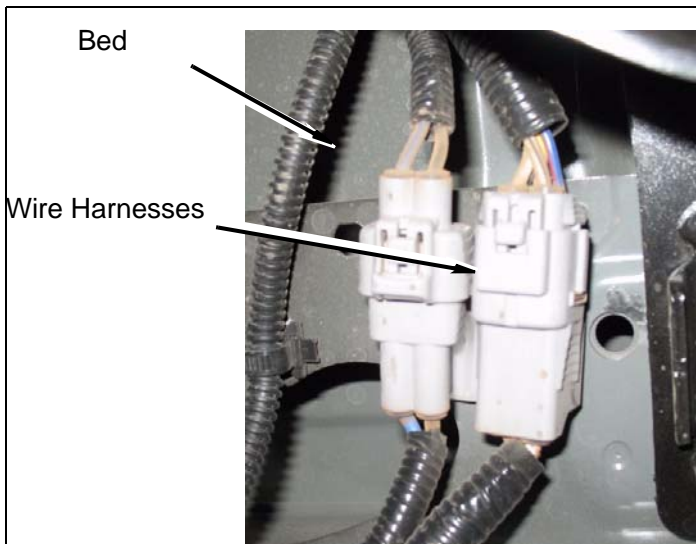

d. Un-clip wire harness from two clips on back side of bumper behind license plate.

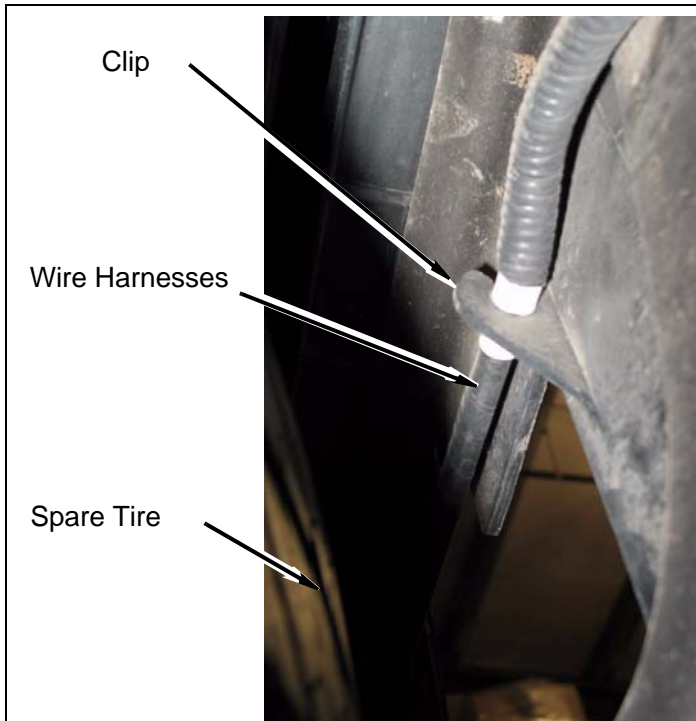

e. Remove two license plate wire harnesses from rear bumper.

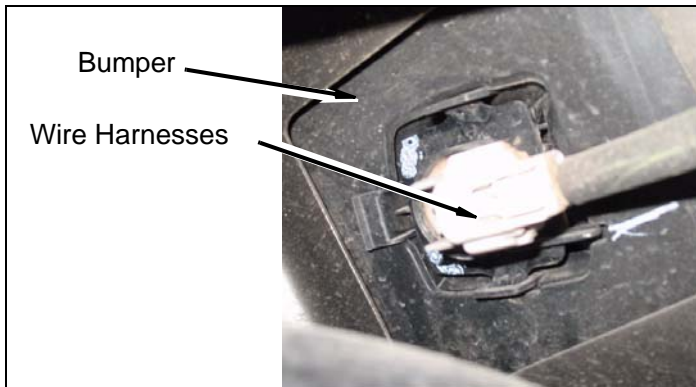

f. Remove rear license plate from vehicle.

g. Remove two plastic end covers on top of rear bumper held on by four clips.

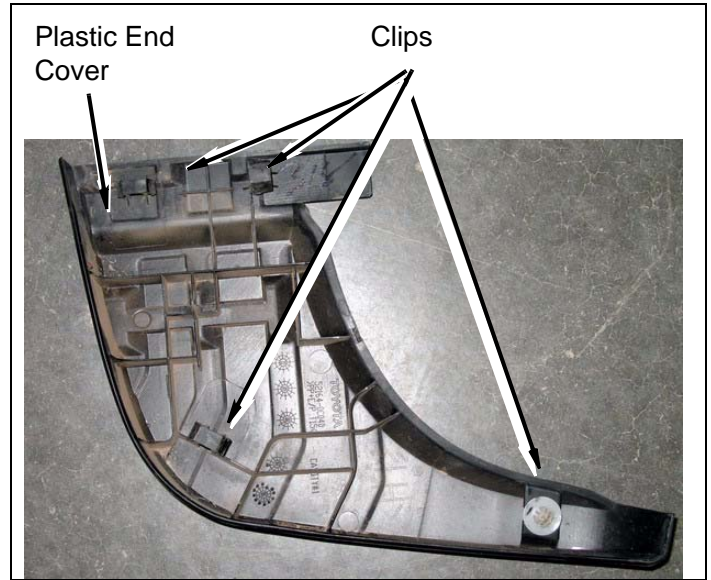

h. Remove rear bumper plastic cover by releasing fourteen clips from bottom of bumper and one in center of license plate.

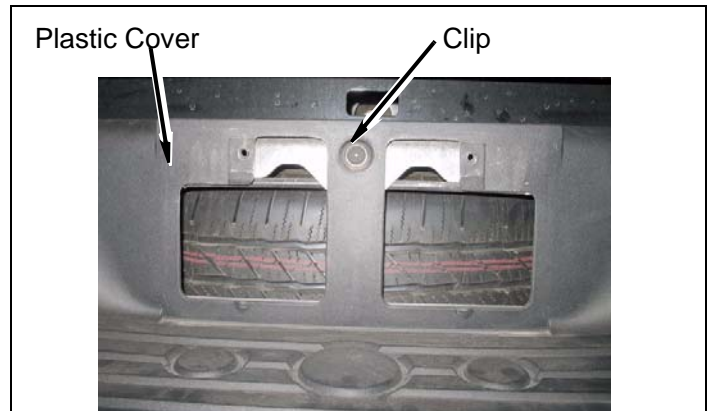

i. Remove eight bolts from rear bumper.

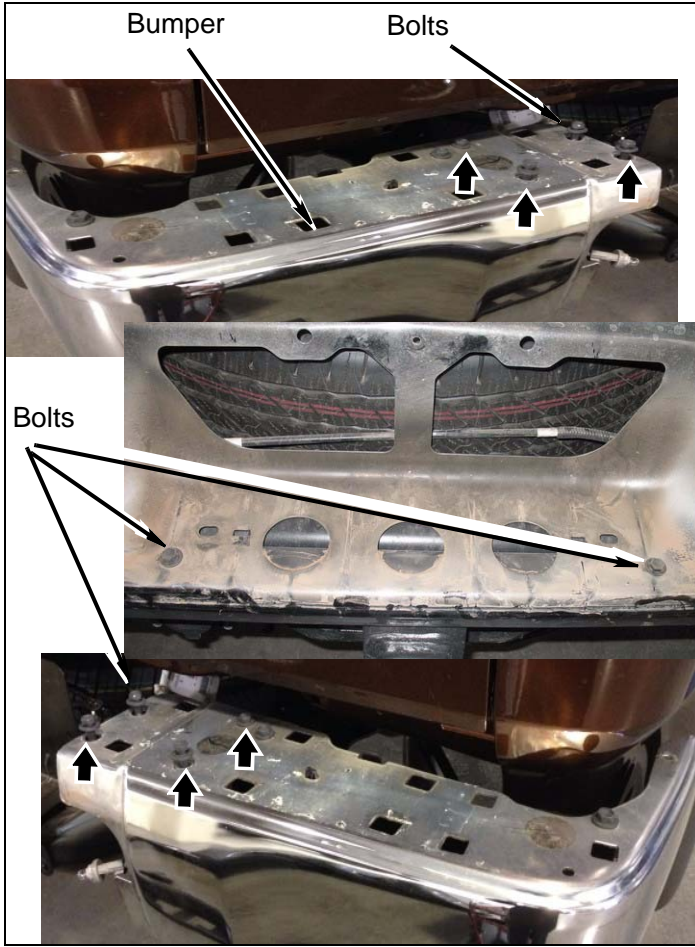

j. Remove two bolts from bumper braces at hitch and remove bumper from vehicle.

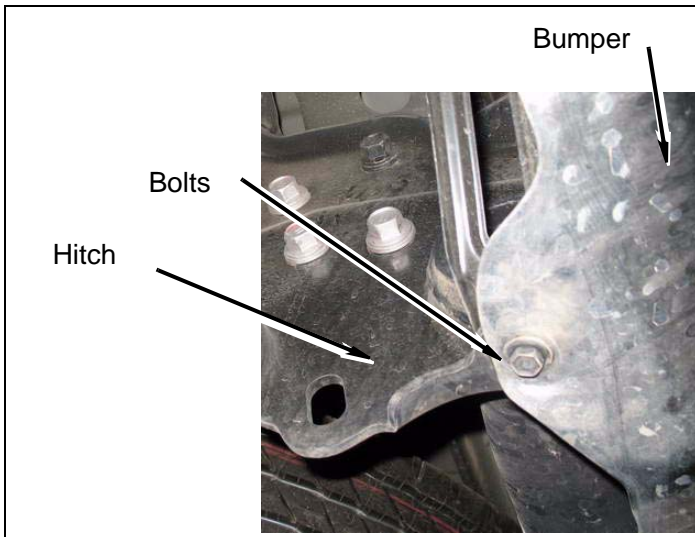

Install Kit

Cab

1. Prepare to lift cab from frame

a. Loosen, but DO NOT REMOVE, cab mounting bolts on driver side.

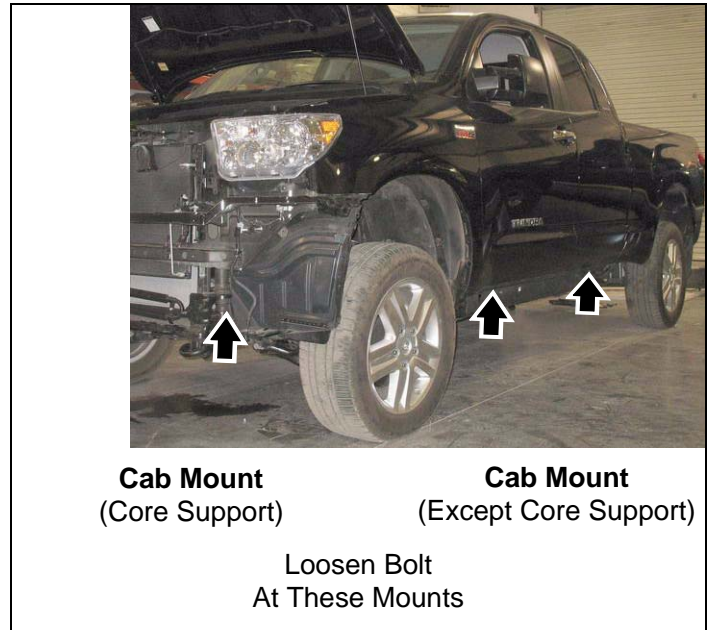

b. Remove bolt and lower bushing from core support on passenger side

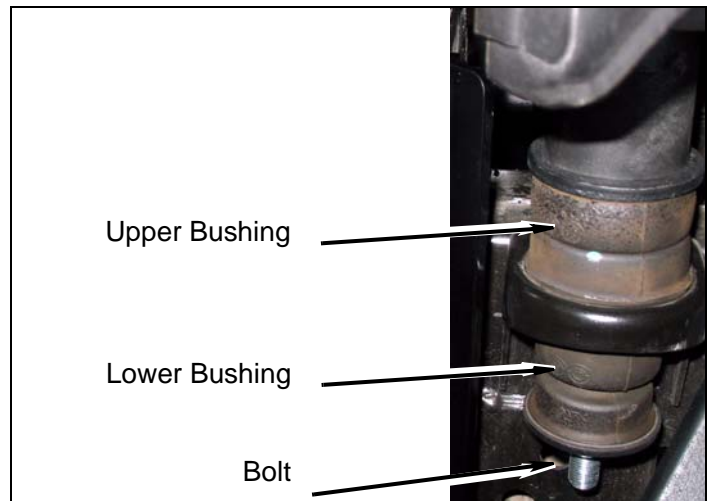

- c. Remove bolt from each body mount on passenger side.



⚠ WARNING

The *kit blocks* must be installed in addition to the factory upper and lower bushings. Installing the *kit blocks* without the factory upper and lower bushings could result in damage to the vehicle or serious personal injury.

- b. Install *kit blocks* (2" x 3") onto upper bushings on core support mount.

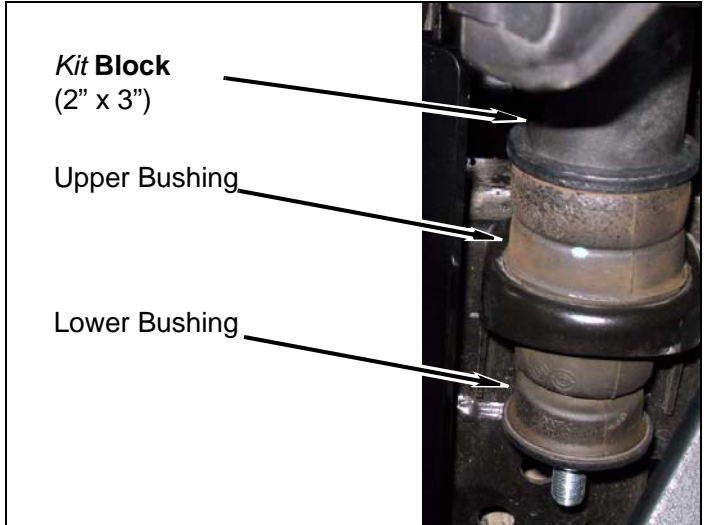

- c. Install *kit blocks* (3" x 3") onto upper bushings on each cab mount.

⚠ WARNING

Use extreme caution when lifting body from frame. To prevent serious personal injury, ensure the lifting device is securely placed. Keep your hands out from between the body and frame.

⚠ CAUTION

Continually check hoses, wires, lines, etc. to be sure that everything is flexing properly and not binding, or damage to the vehicle could result. Be especially careful of the a/c hoses at the fire wall, the belt pulley, and at the core support. Ensure brake lines stretch while lifting. Bending the lines to gain ample slack may be necessary. Be extremely careful not to kink the lines.

2. Cab passenger side

- a. Position a hydraulic floor jack and a wood block under passenger side of cab (under the body seam). Slowly lift cab just enough to install a **kit block** on top of factory upper bushing.

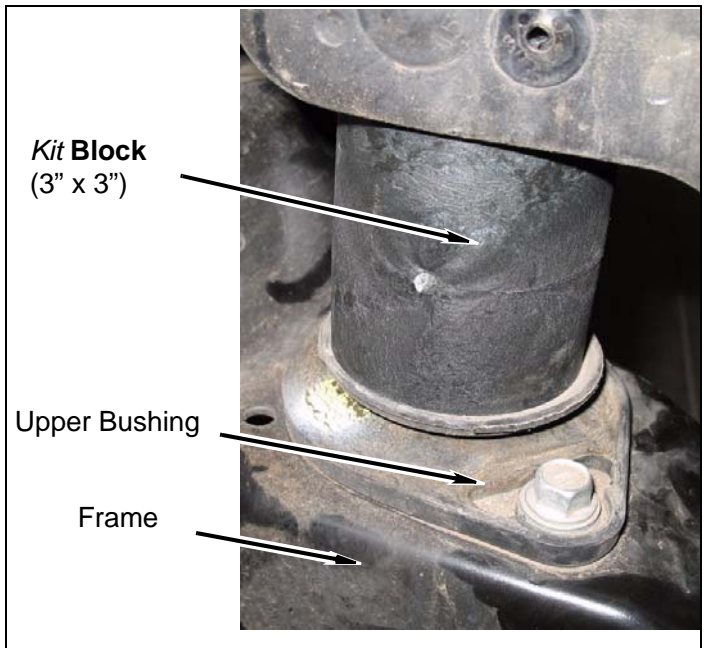

- d. Lower cab onto *kit blocks* (3" x 3").

e. Remove factory washers from factory bolts.

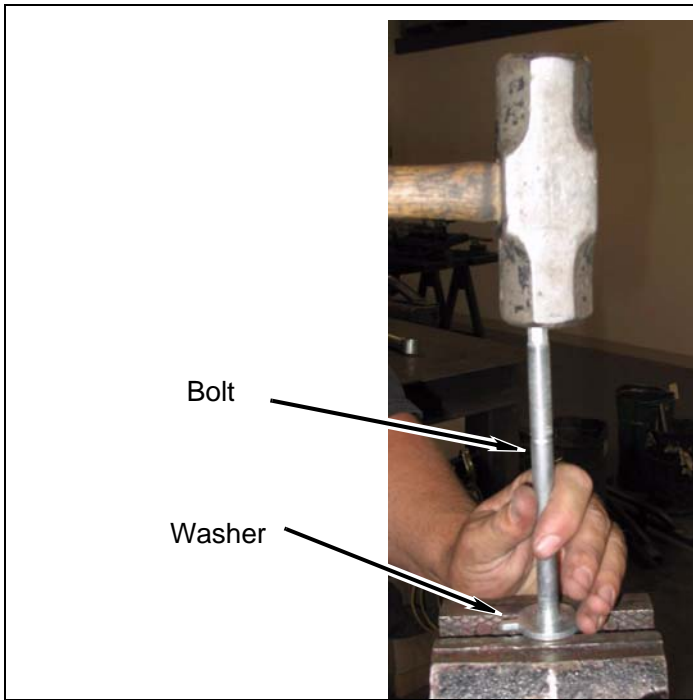

f. Install *kit bolt* (12mm-1.25 x 225mm), washer, lower core support bushing, washer, and nut. DO NOT TIGHTEN.

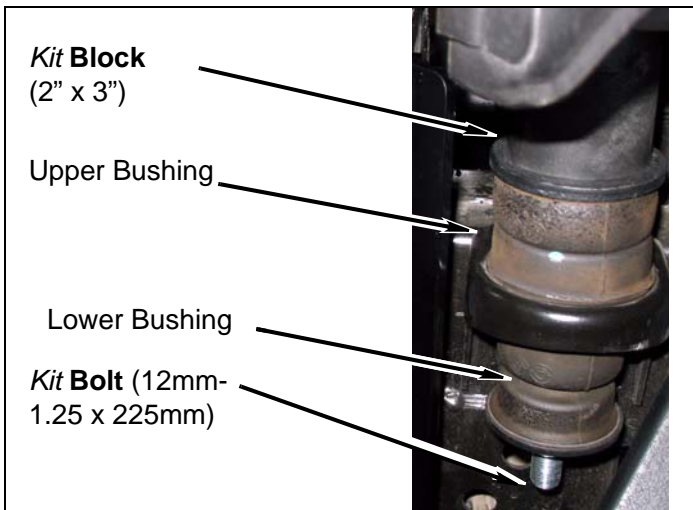

g. Install *kit bolt* (12mm-1.25 x 225mm), washer, OEM large washer, and nut on front cab mount. DO NOT TIGHTEN.

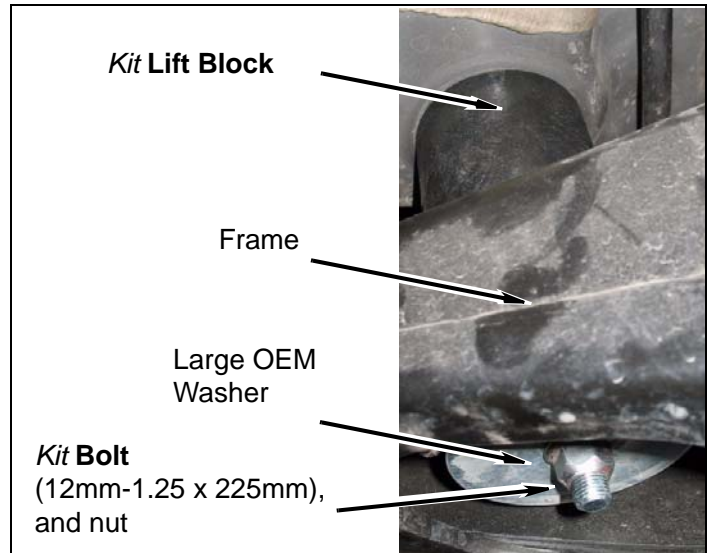

h. Install washer, nut, and *kit bolt* (12mm-1.25 x 275mm) on rear cab mount. DO NOT TIGHTEN

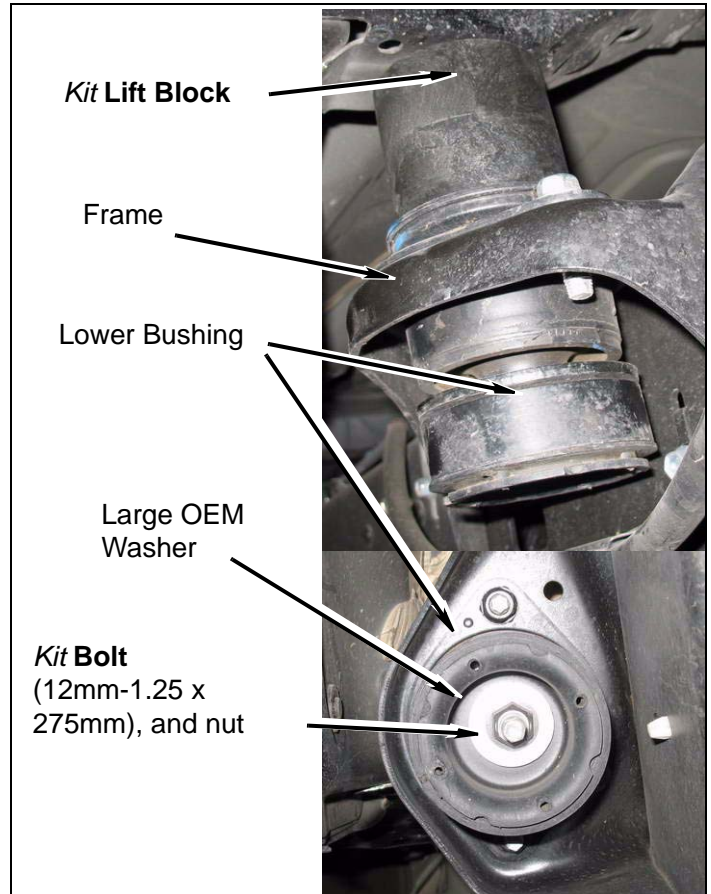

3. Cab driver side

- a. Repeat previous steps on driver side of cab.
- b. Set cab-to-bed spacing according to previous measurement.

- c. Remove each *kit bolt*, one at a time, and apply a small amount of *kit Loctite*® onto threads. TIGHTEN *kit bolts* to 55 ft. lbs.

- c. Install two plastic nuts from kick panel under dash.

Inside of Vehicle

1. Trim

- a. Replace plastic plug and carpet at each rear corner.

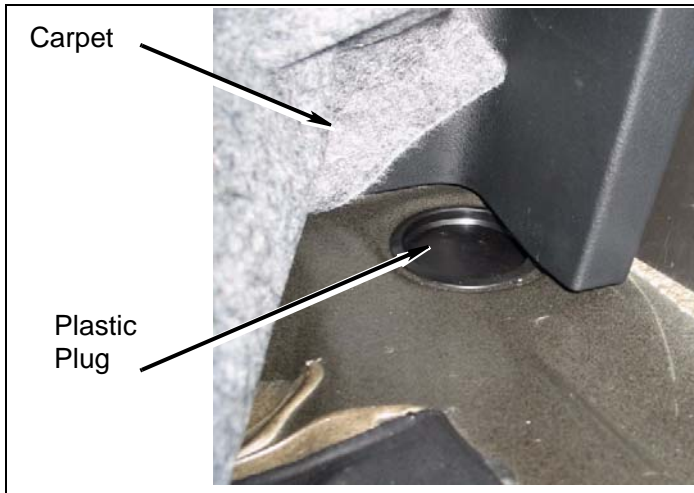

- b. Replace plastic plug and carpet at each front corner.

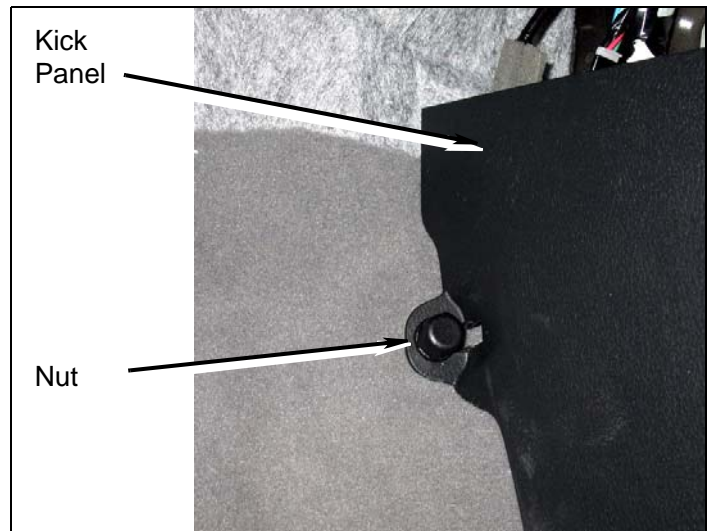
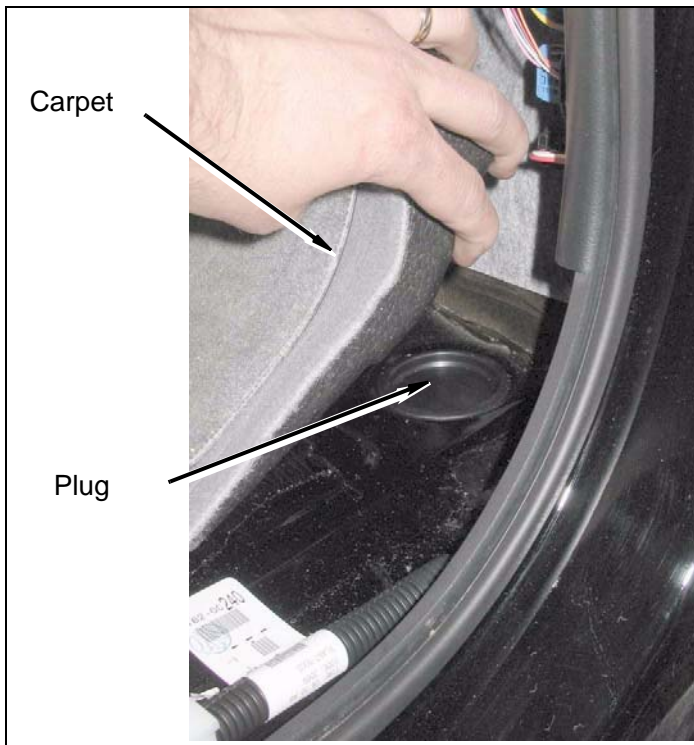

- d. Install kick panel on both passenger and driver side.

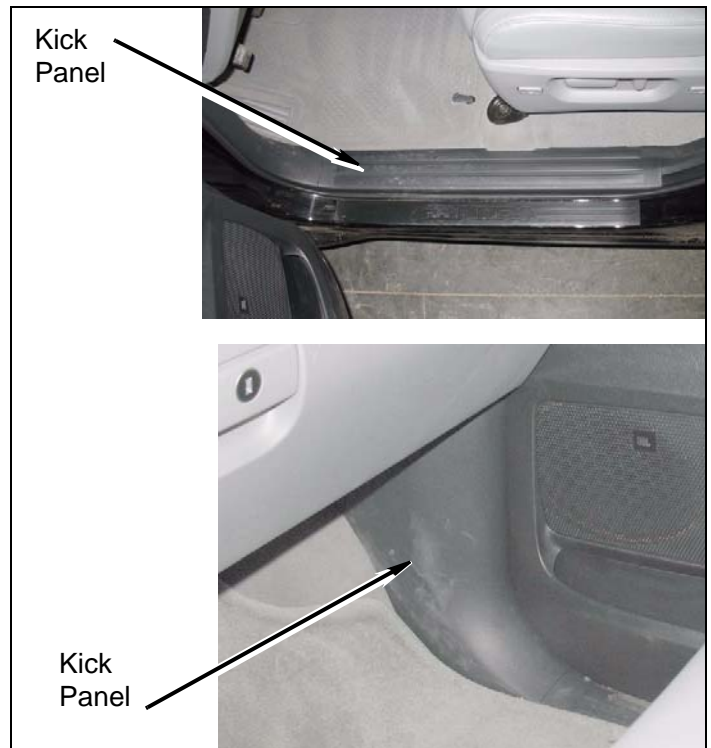

Bed

- 1. Prepare to lift bed from frame

- a. Loosen, but **DO NOT REMOVE**, bed mounting bolts on driver side (three bolts on vehicles with short bed; four bolts on vehicles with long bed).

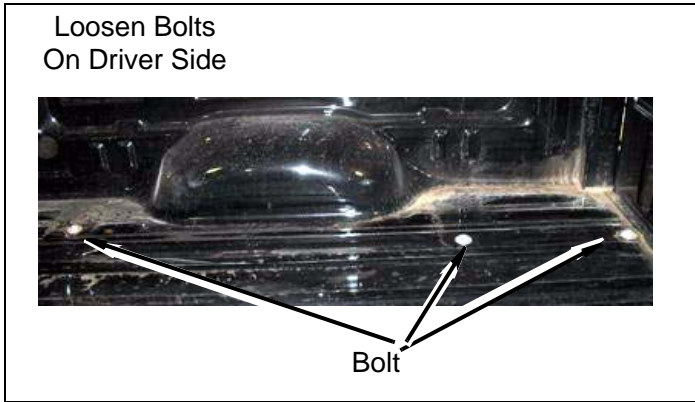

NOTE
The number of bed mounting bolts may vary with the length of the bed.

- 2. Remove bolt from each bed mount on passenger side.

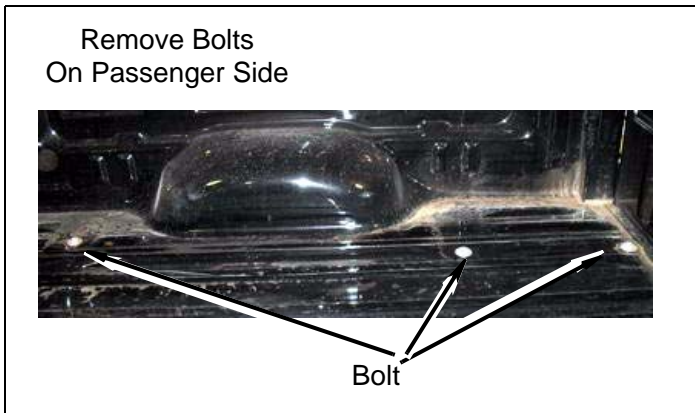

⚠ WARNING
Use extreme caution when lifting the bed from the frame. To prevent serious personal injury, ensure the lifting device is securely placed. Keep your hands out from between the bed and frame.

⚠ CAUTION
To prevent damage to the vehicle while lifting the bed, continually check hoses, wires, brake lines, etc. to ensure everything is flexing properly and not binding. Ensure clearance between bed and cab is maintained.

3. Bed passenger side

- a. Using a hydraulic floor jack and a wood block, slowly lift passenger side of bed a little more than 3".

- b. Install a **kit block** (2" x 3") on frame at mount closest to back end of bed.

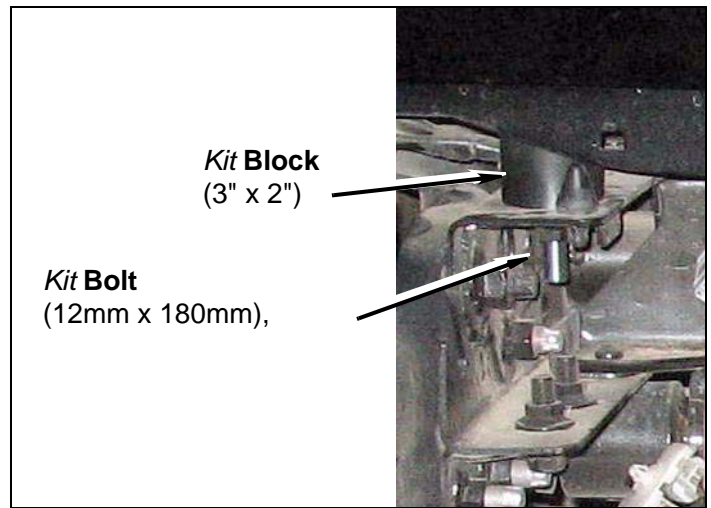

- c. Install two **kit blocks** (3" x 3") on two other frame mounts.

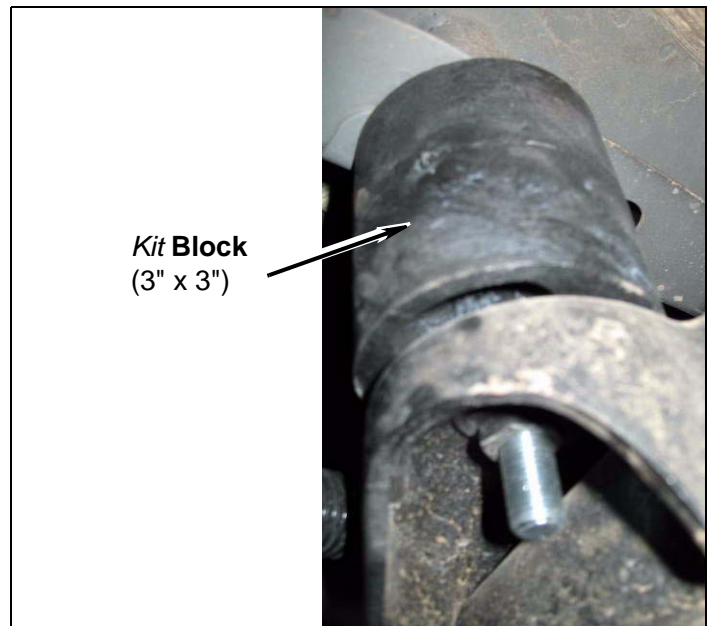

- d. Lower bed onto **kit blocks**.
- e. Install **kit bolts** (12mm -1.25 x 180mm) and factory washers onto each bed mount. **DO NOT TIGHTEN**.
- f. Repeat previous steps on driver side of bed.
- g. Set bed-to-cab spacing according to previous measurement.

- h. Remove each *kit bolt* (12mm -1.25 x 180mm), one at a time, and apply a small amount of *kit Loctite®* onto threads. Install *kit bolt* (12mm -1.25 x 180mm) and factory washer. **TIGHTEN *kit bolt* to 55 ft. lbs.**

- a. Mark and cut rear bumper shell and reinforcement plate as shown below:

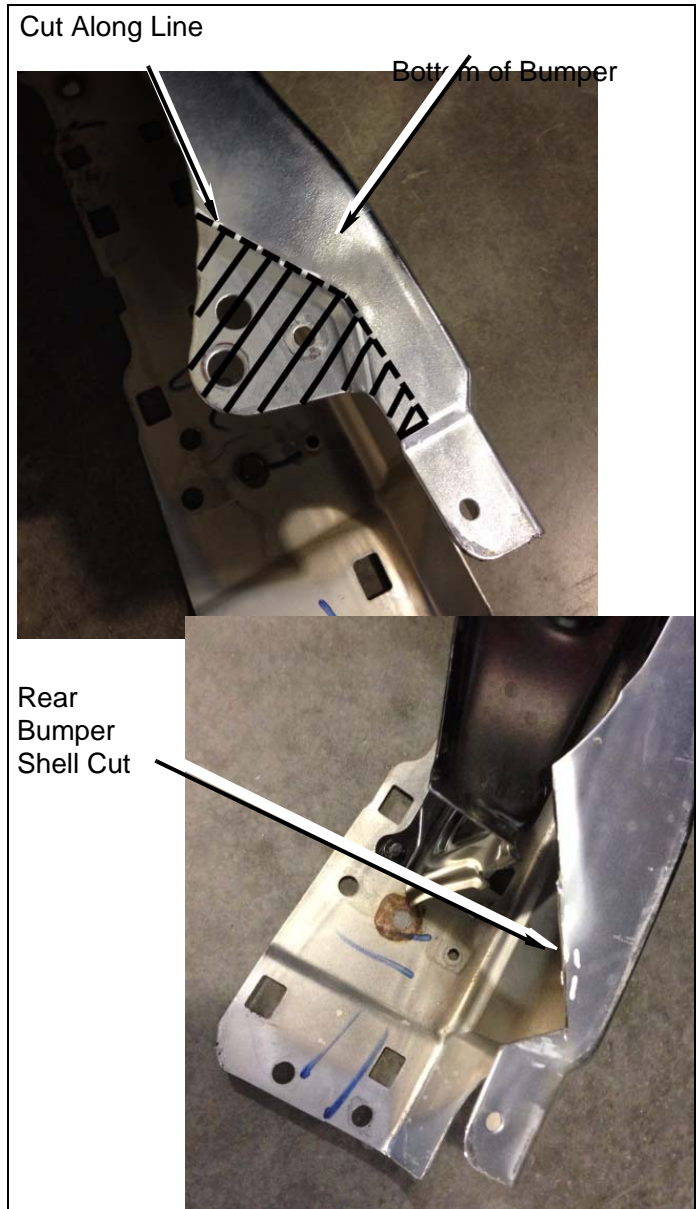
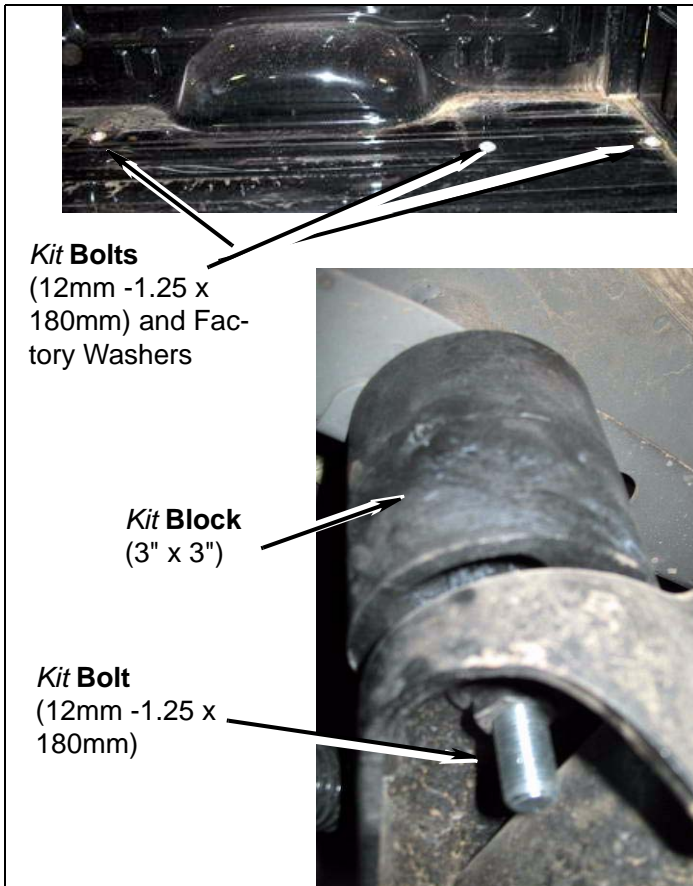

Rear of Vehicle

- 1. Rear bumper

⚠ WARNING

The following procedure is intended only to enhance the appearance of the vehicle. The rear bumper will no longer be rated for towing of any kind. Towing with the rear bumper after it has been lifted can result in death, serious personal injury, or damage to the vehicle. Towing after the bumper has been lifted should be accomplished using a rated Class III receiver type hitch.

- b. Position rear bumper on frame using four *kit blocks* (2" x 3") and center support plate onto *kit bracket* (center).

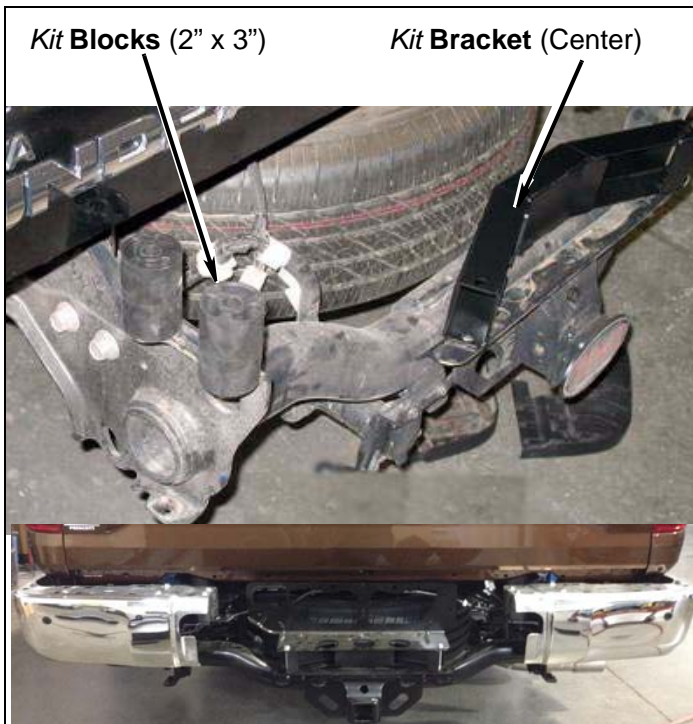

- c. Install rear bumper on frame using four *kit blocks* (2" x 3"), *kit bracket* (center), six *kit bolts* (8mm x 90mm), and six *kit washers* (1/4" USS)

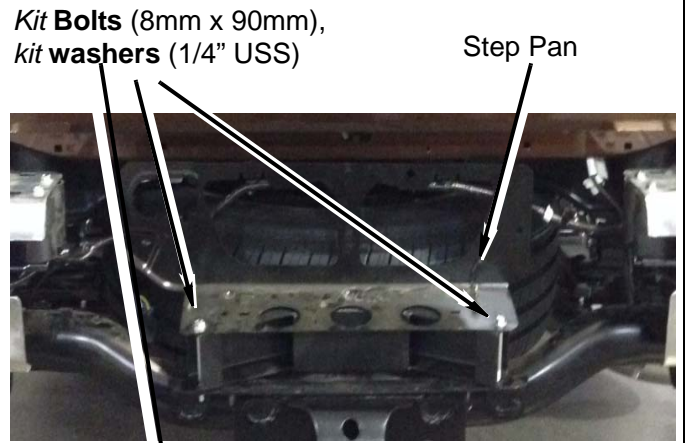
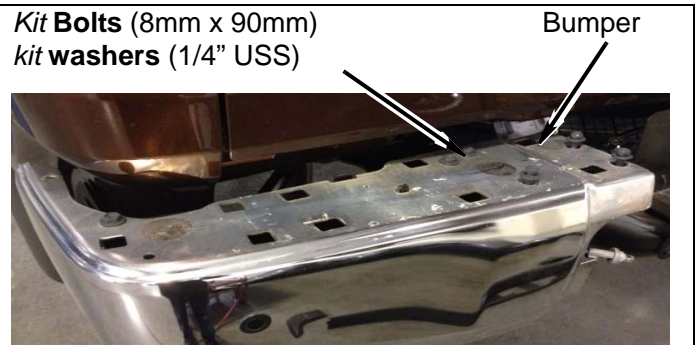

- d. Install two *kit bracket* (side support), four factory bolts, two *kit bolts* (1/4" x 1"), four *kit washers* (1/4" SAE), two *kit nut* (8mm nylock) and two *kit nut* (1/4" nylock).

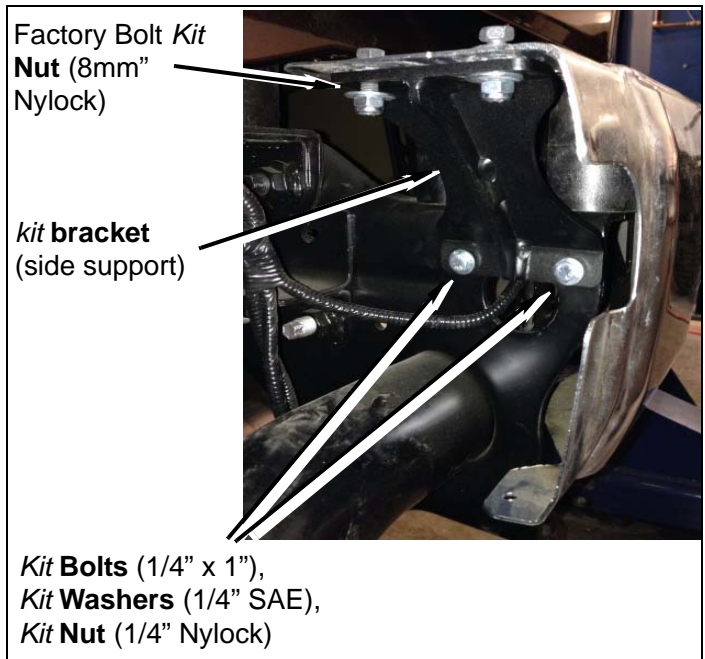

- e. Drill 1/4" hole into lower rear bumper shell and install *kit bracket* (support), two *kit bolts* (1/4" x 1"), four *kit washers* (1/4" SAE), and two *kit nut* (1/4" nylock) for each side.

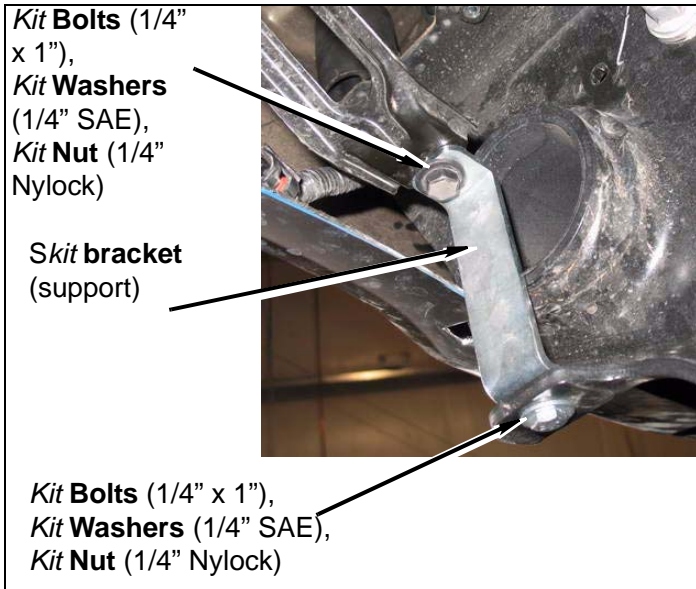

2. Fuel Filler

⚠ WARNING
Use extreme caution when working near the fuel lines and the fuel tank. Clean up spilled fuel immediately. A spark could cause an explosion or fire resulting in serious personal injury and property damage.

- a. Install two nuts, bracket and fuel filler on vehicle.

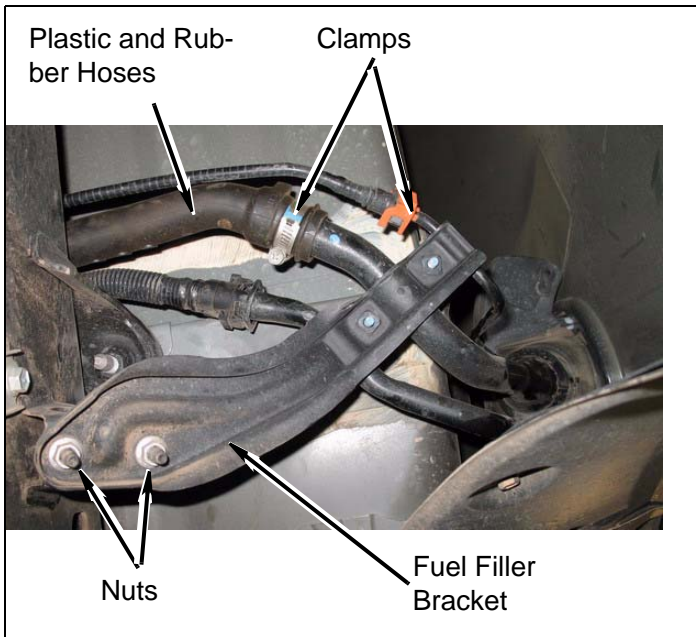

- b. Connect plastic and rubber hoses to metal fuel filler lines.

Underside of Vehicle

1. Wire harnesses and brake lines

- a. Using *kit zip tie*, connect the axle vent tube to the brake lines.

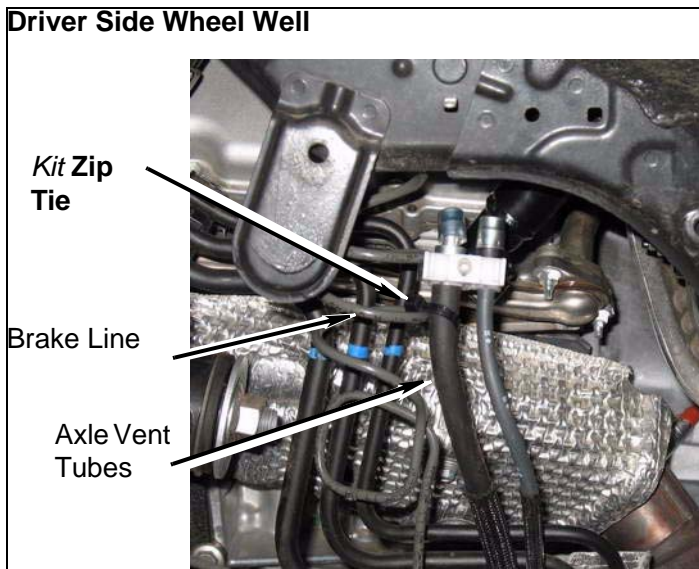

2. Crush Blocks

3. Install mid-bed *kit Blocks* (crush)

- a. Remove four rubber contact pads pressed into underside of truck bed above frame rail in wheel well area.
- b. Install one of rubber pads removed onto *kit Blocks* (crush)..

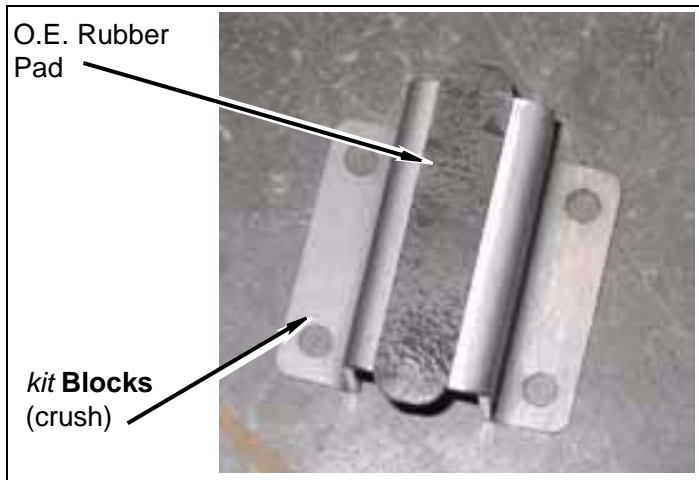

- c. Install two **kit Blocks** (crush) where pads were removed. Secure using **kit bolts** (1/4" x 3/4) with **hardware**.

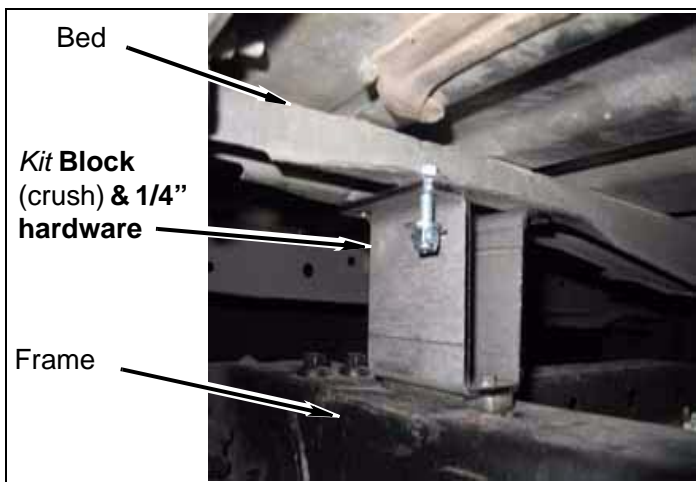

- c. Apply a small amount of **kit Loctite®** onto factory bolt and **kit bolt** (3/8" x 1 1/4").

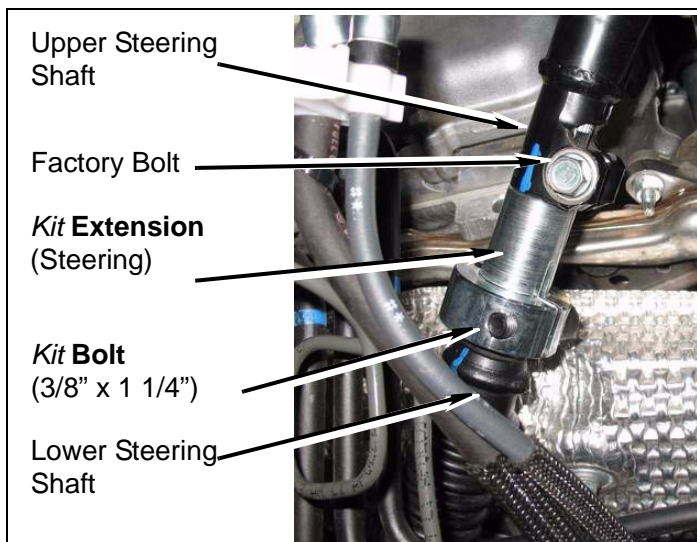

4. Park Brake Cable

- a. Install **kit bracket** (parking brake) and nut to underside of body. Install park brake cable bracket, **kit bolt** (1/4" x 1"), two **kit washers** (1/4" SAE), and **kit nut** (1/4" nylock).

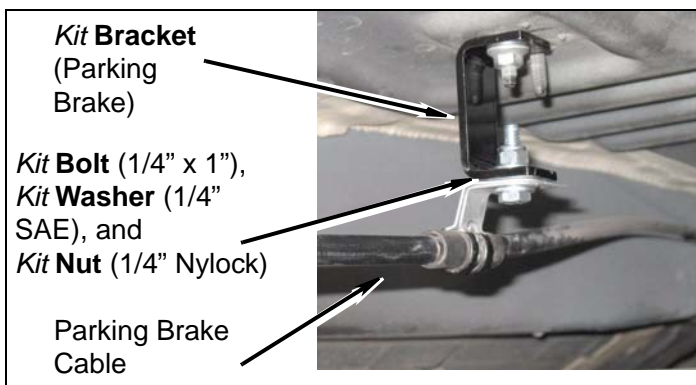

- d. Install and tighten bolts to 33 lb.-ft.

- e. Shift battery cable in direction of battery to gain as much slack as possible. Clip positive battery cable, starting from passenger side, in two clips along bottom of engine.

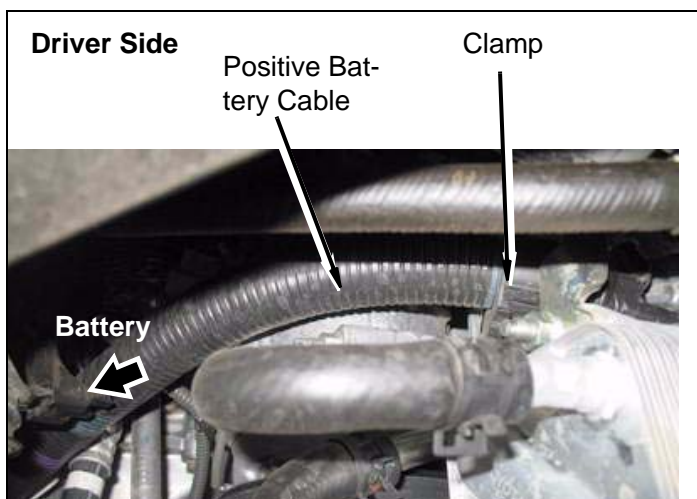

Engine Compartment

1. Steering shaft

⚠ WARNING

Verify the steering extension is securely installed as specified in the instructions. Failure to do so may cause steering malfunction, resulting in property damage or serious personal injury.

- a. Install **kit extension** (steering) onto upper steering shaft. Ensure marks on upper steering shaft and lower steering shaft are aligned.
- b. Install lower steering shaft onto **kit extension** (steering), ensuring marks on upper steering shaft and lower steering shaft are aligned.

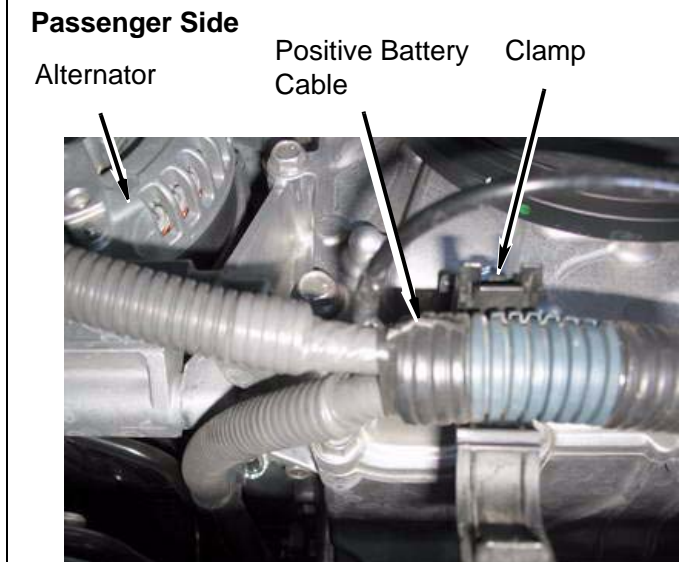

2. Air Box

- a. Install two bolts and airbox onto fender. DO NOT TIGHTEN BOLTS

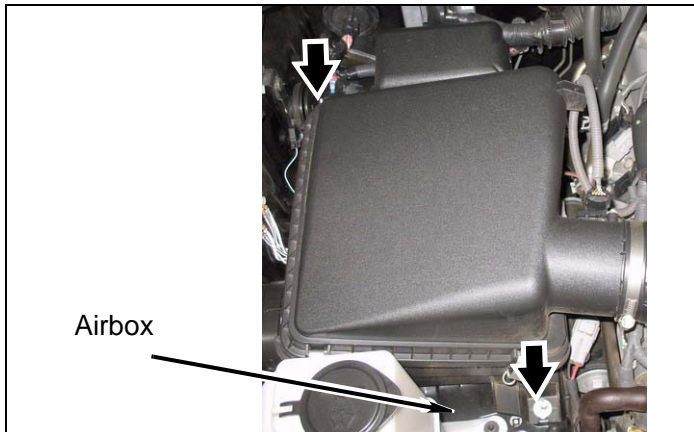

- b. Connect air inlet hose to intake manifold and airbox cover. Tighten both hose clamps.

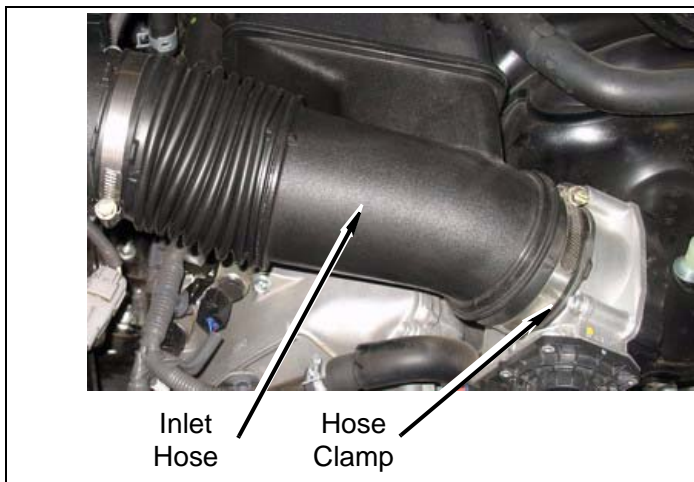

- c. Secure the airbox cover to the airbox with the four clips.

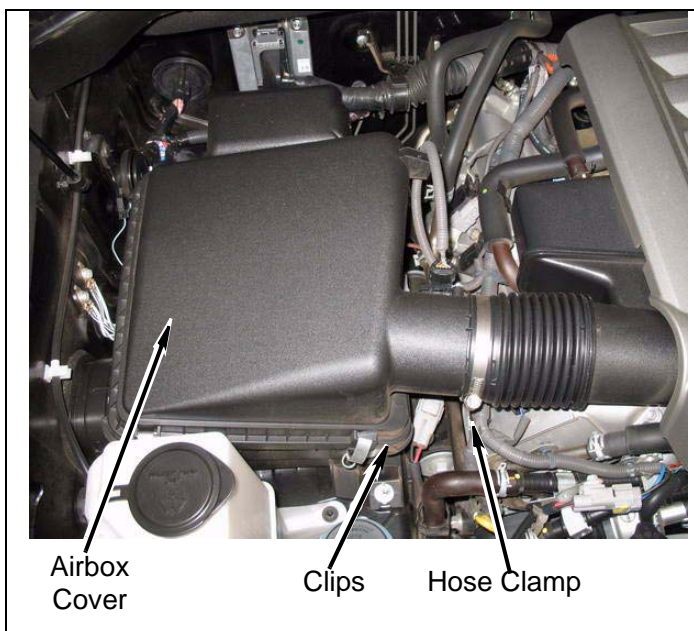

- d. Tighten two airbox bolts and secure airbox to fender.

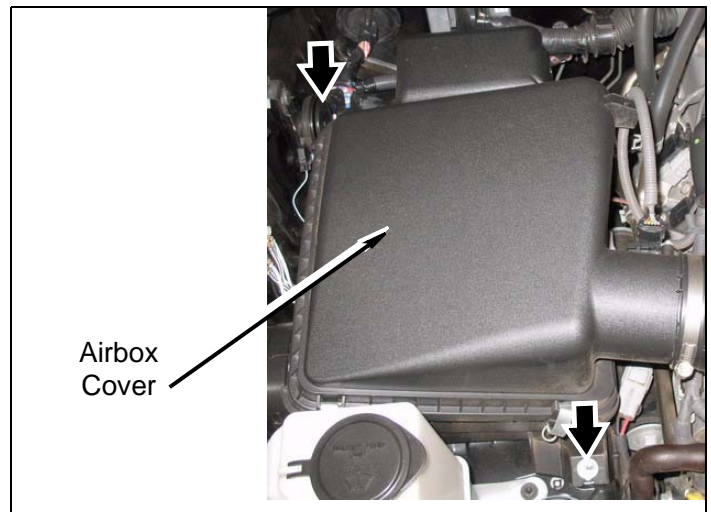

3. Fan Shroud

- a. Trim off tabs near each upper radiator mounting holes.

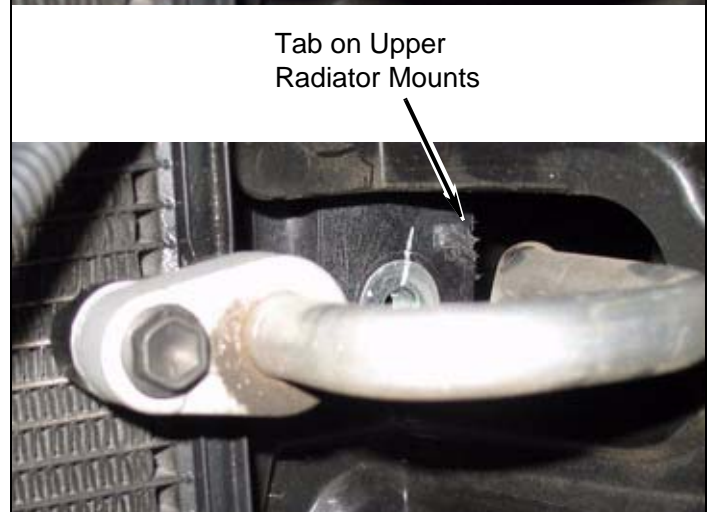
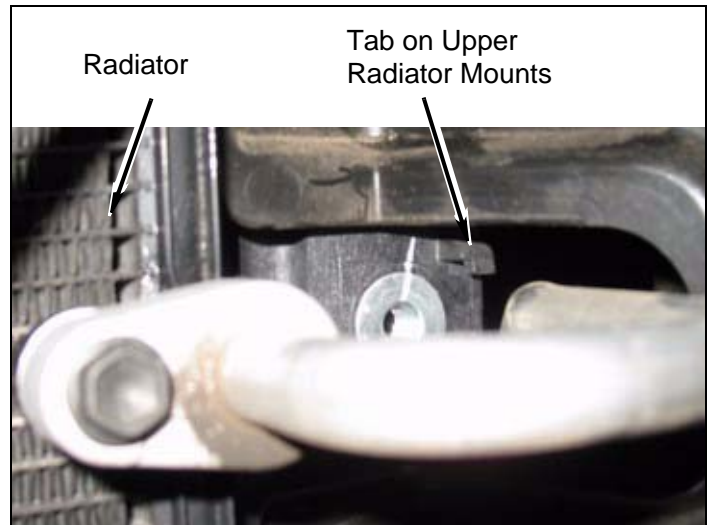

- b. Install four **kit brackets** (radiator, 3"), four **kit washers** (1/4" SAE), and four **kit nuts** (1/4" nylock) to core support. Studded end should go through core support.

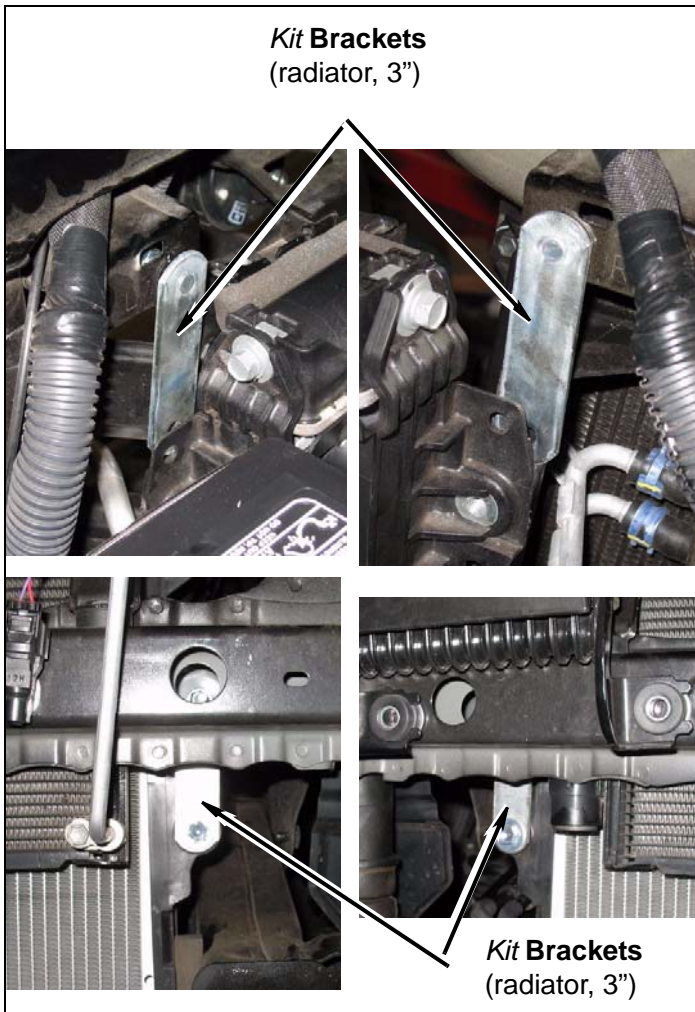

- c. Install radiator to lower end of **kit brackets** (radiator, 3") using factory bolts.

Front of Vehicle

1. Front bumper

2. Install kit brackets (driver and passenger) onto front frame horns using six OEM nuts.

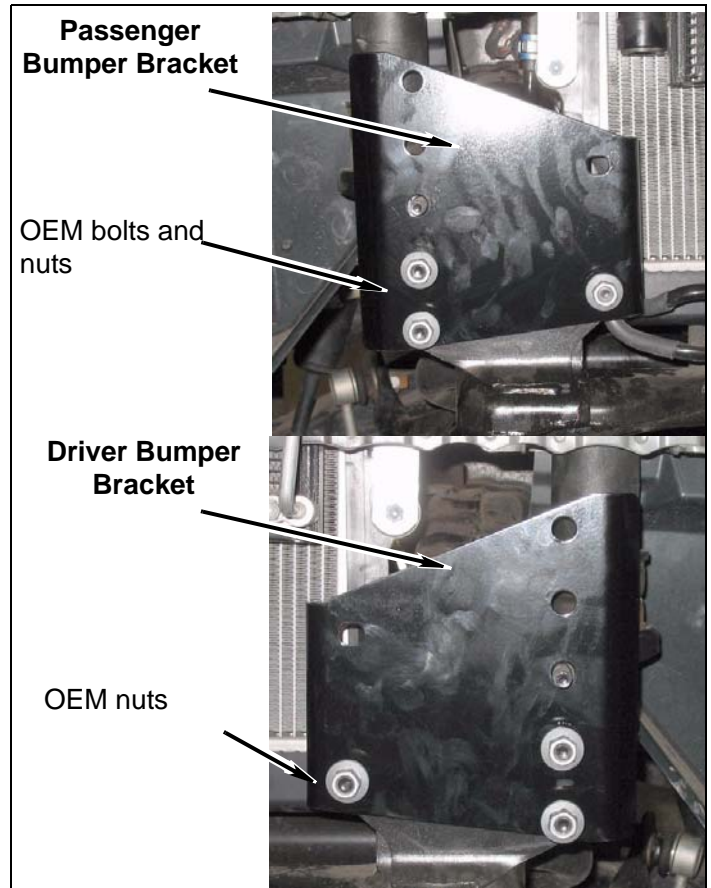

- a. Install OEM driver and passenger side bumper brackets using two factory nuts, six **kit bolts** (10 mm x 30mm), twelve **kit washers** (10 mm), and six **kit nuts** (10 mm nylock).

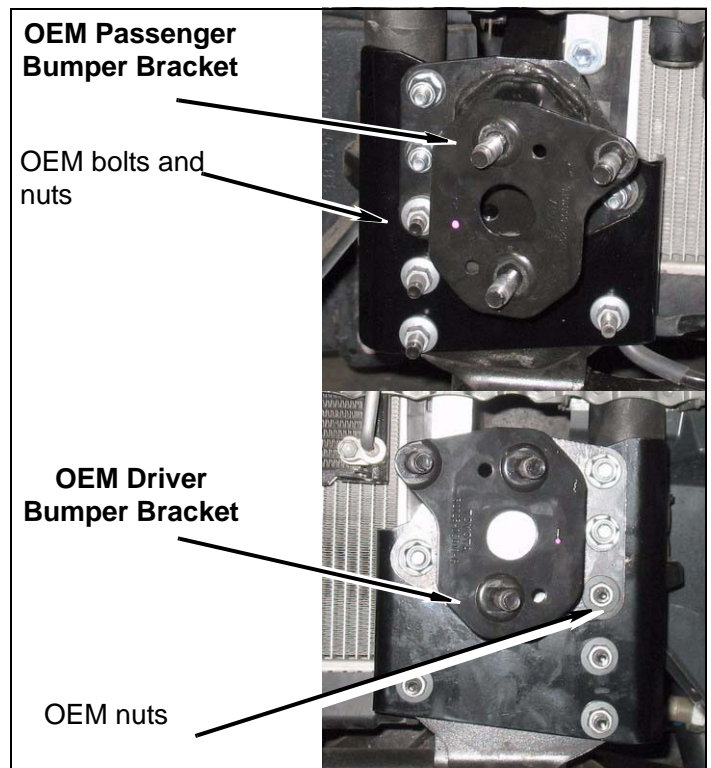

b. Install six nuts and bumper on vehicle.

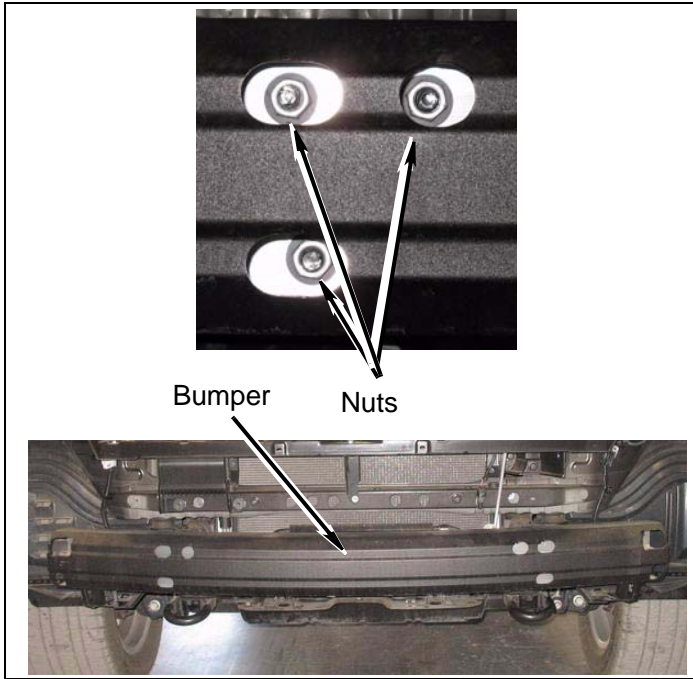

c. Install front fascia on bumper.

d. Pull back panel from under head lamp and install two bolts.

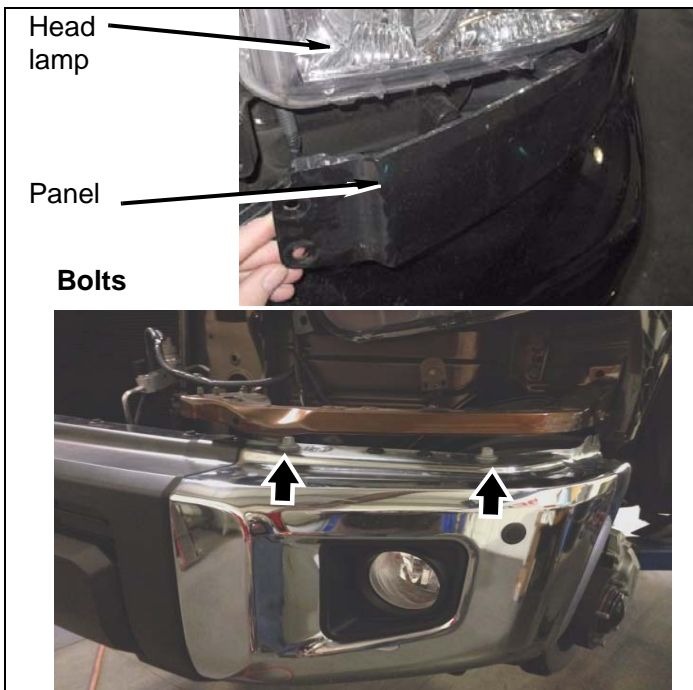

e. Install four push clips from panel.

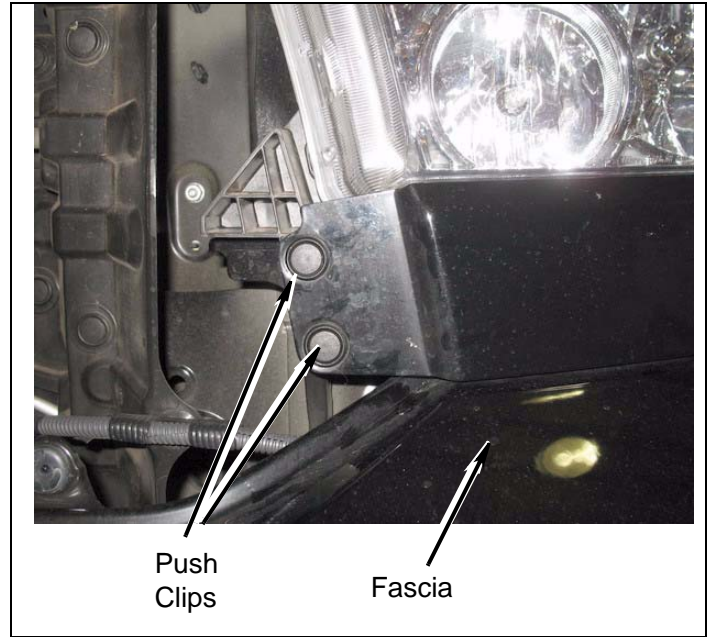

f. Install four bolts on each corner under fascia.

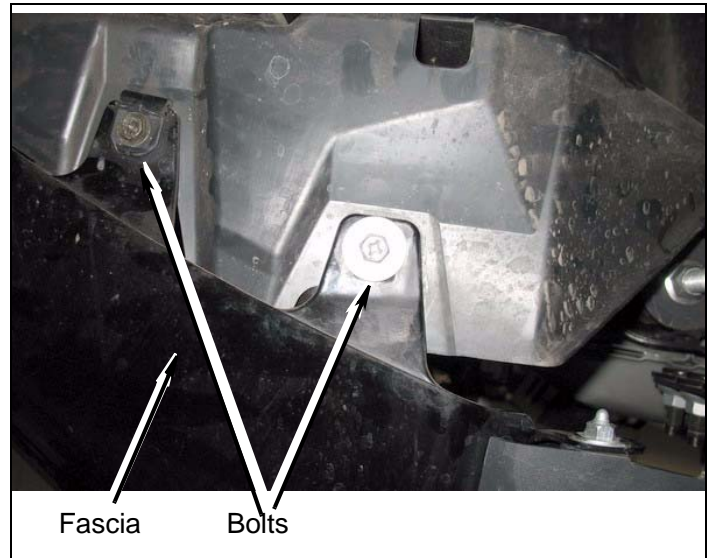

g. Install four push clips from front fascia.

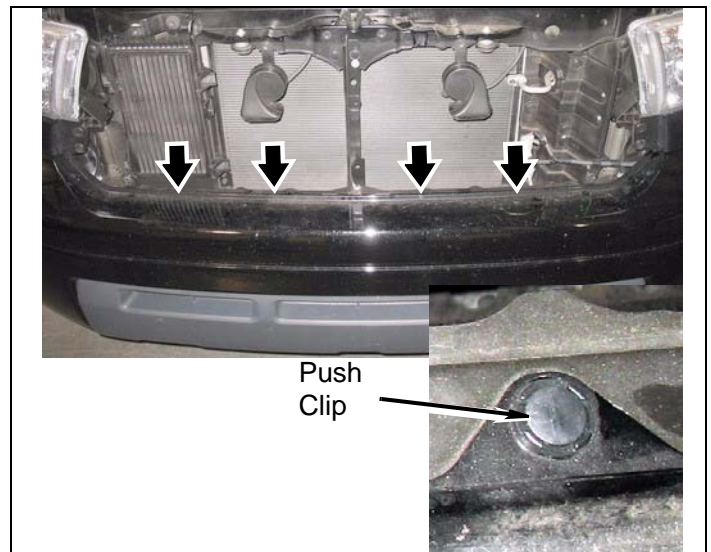

h. Install two bolts in wheel well.

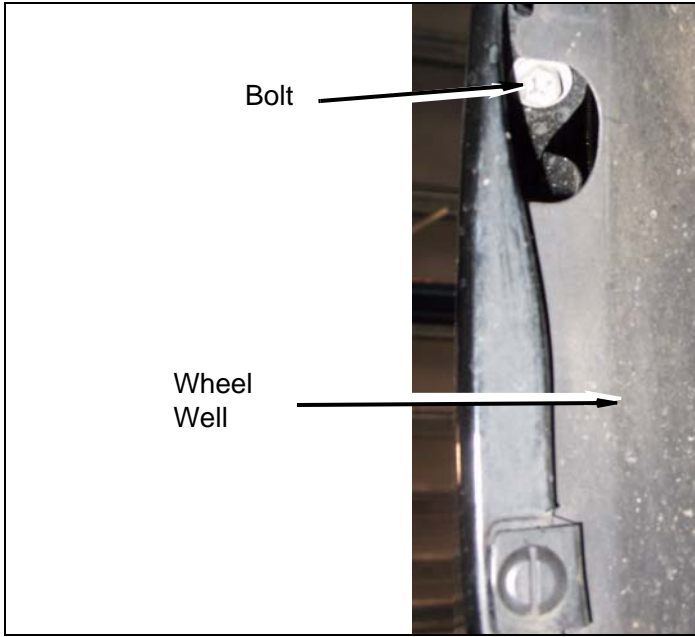

i. Install two clips in both front wheel wells

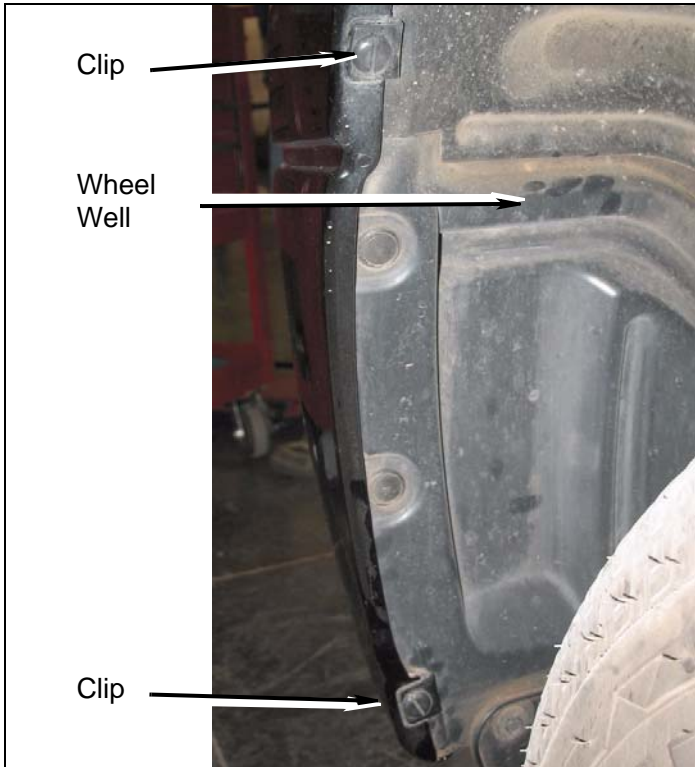

j. Install grille assembly, followed by four bolts and two clips.

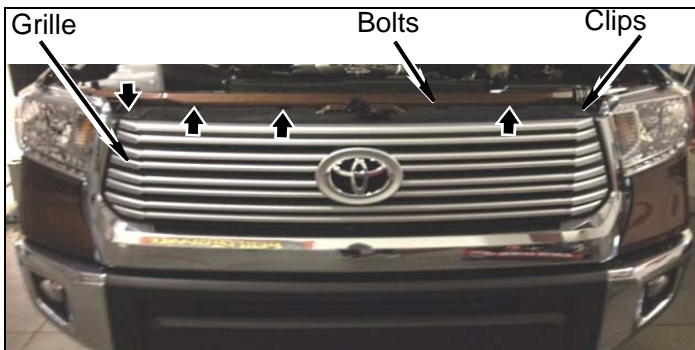

k. Connect wire harness at two fog lamps.

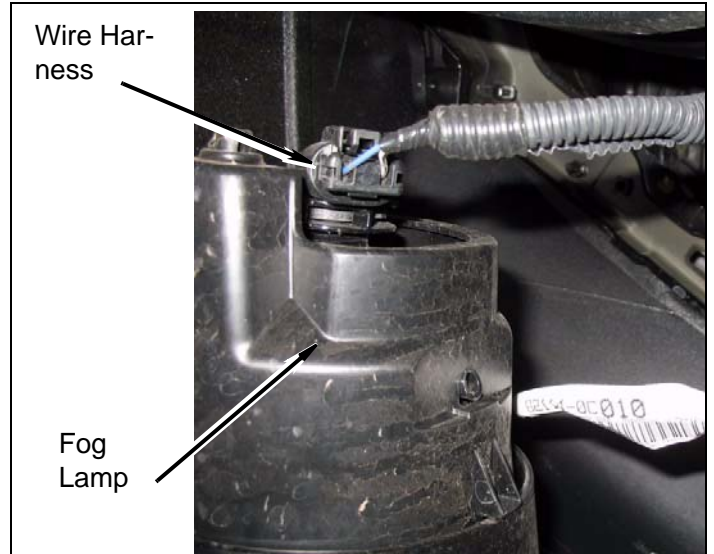

l. Connect two park assist wire harnesses at each corner of front fascia.

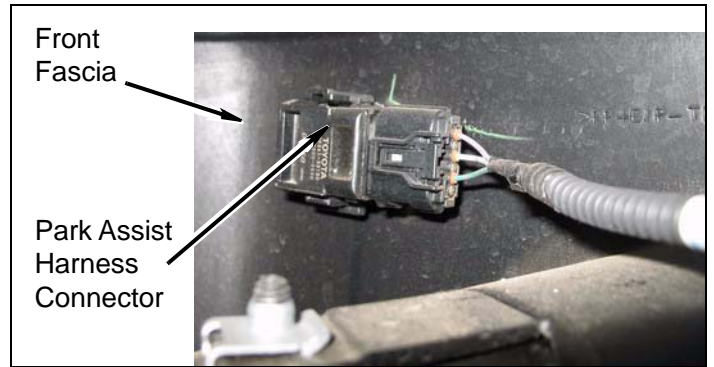

m. Install five bolts and front engine splash shield on vehicle.

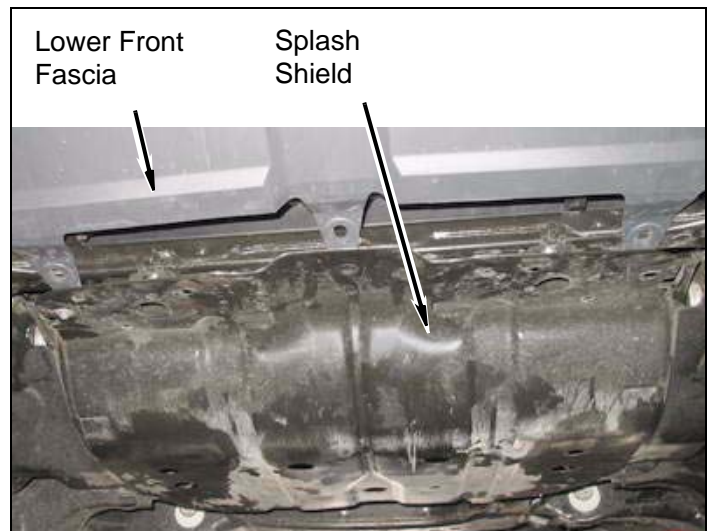

After Completing Installation

Engine Compartment

1. Install airbag fuse and fuse block cover.
2. Connect both battery cables. Connect positive cable first, then negative cable.

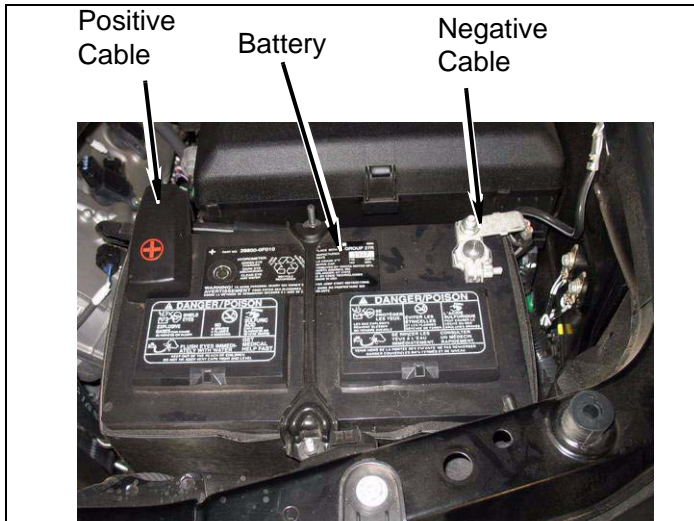

3. Install engine cover on engine by pressing cover onto two retaining posts.

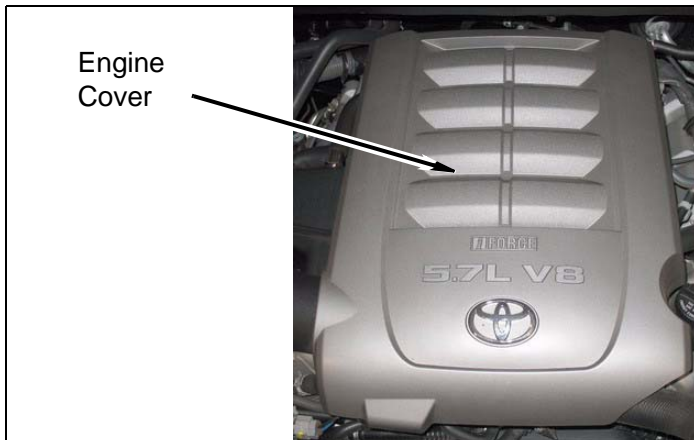

Miscellaneous

1. Apply **kit label** (warning) onto dashboard in plain sight of all vehicle occupants.
2. Check all fasteners to ensure they are tight.
3. Ensure all wires, hoses, cables, etc. are properly connected and there is ample slack.

4. Adjust headlights.

⚠ WARNING

If the engine cooling system is hot, the coolant will be **HOT** and **UNDER PRESSURE**. To prevent serious personal injury, wait until the cooling system is completely cool before removing the cap from the radiator.

5. Top off power steering fluid and re-check after test drive.

Dynamic Vehicle Check

1. Check steering in both directions to ensure that there is no bind. Check operation of clutch, brake system, and parking brake. Check operation of transmission and transfer case. Ensure there is full engagement in all gears and 4WD ranges. Check battery connections and electrical component operations. Test-drive vehicle.

⚠ WARNING

Retorque all fasteners after 500 miles and after off road use. All body lift components should be visually inspected and fasteners retorqued during routine vehicle servicing.

⚠ CAUTION

Performance Automotive Group does not recommend any particular wheel and tire combinations for use with its body lifts and cannot assume responsibility for the customer's choice of wheels and tires. Refer to your owner's manual for recommended tire sizes and warnings related to the use of oversized tires. Larger wheel and tire combinations increase stress and wear on steering and suspension components, which leads to increased maintenance and higher risk for component failure. Larger wheel and tire combinations also alter speedometer calibration, braking effectiveness, center of gravity, and handling characteristics. Consult an experienced local off road shop to find what wheel and tire combinations work best with your vehicle.

NOTE

All warranty information, instruction sheets, and other documents regarding the installation of this product must be retained by the vehicle owner. Information contained in the instructions and on the warranty card will be required for any warranty claims. The vehicle owner needs to understand the modifications made to the vehicle and how they affect vehicle handling and performance. Failure to provide the customer with this information can result in damage to the vehicle and severe personal injury.

Kit Parts List

Accessories

Qty. Description

Kit# 6344 Gap Guards

1	Hose, 5/8" x 5"
1	Hose, 1" x 5"
1	Hose 3/8" x 5"
1	Bracket, Bumper Driver Front
1	Bracket, Bumper Passenger Front
1	Bracket, Rear Bumper Center
2	Bracket, Rear Bumper Support
2	Bracket, Rear Inner Bumper Support
4	Block, Crush 2" x 3"
10	Block, Lift 3" x 3"
8	Block, Lift 2" x 3"
1	Instructions
1	Lable, Logo
1	Lable, Warning
1	HP5643 (Hardware bag kit)
8	Bolt, 1/4" x 1"
16	Bolt, 1/4" x 3/4"
6	Bolt, 10mm x 30mm
6	Bolt, 8mm x 90mm
42	Washer, 1/4" SAE
18	Washer, 1/4" USS
12	Washer, 10mm
4	Washer, 8mm
30	Nut, 1/4" Nylock
6	Nut, 10mm Nylock
4	Nut, 8mm Nylock
4	Clamp, Hose #6
4	Clamp, Hose #10
2	Clamp, Hose #28
4	Bracket, Radiator 3"
2	Zip Tie
1	Bracket, Park Brake
1	Tube, Power Steering Extension (3/8" x 5")
1	Tube, Power Steering Extension (7/16" x 5")
1	<u>BP5643 (Bolt Pack)</u>
4	Bolt, 12mm x 225mm
2	Bolt, 12mm x 275mm (2014 Rear Cab Bolts)
1	Extension, Steering
1	Bolt, 3/8" x 1 1/4" Alan
6	Bolt, 12mm x 180mm

NOTE

Depending on the vehicle configuration (automatic or manual transmission, 2WD or 4WD, cab length, bed length, etc.), some parts may not be used.

Rev. 00, Copyright 03/14
Performance Automotive Group
www.p-a-g.net